

# L02 Series DIO Module User Manual

Thank you for purchasing Coolmay L02 series DIO module. This manual mainly describes the product characteristics, general specifications and wiring methods of the module. For detailed usage, please refer to "Coolmay L02 Series PLC Programming Manual".

The L02 series DIO module has the following characteristics:

1. Used with Coolmay L02 series CPU, the address is automatically assigned.
2. Standard DIN rail (35mm width) and Snap-in buckle installation, easy to install and unload.
3. Adopts push-type terminals, convenient for wiring.

## Product Structure

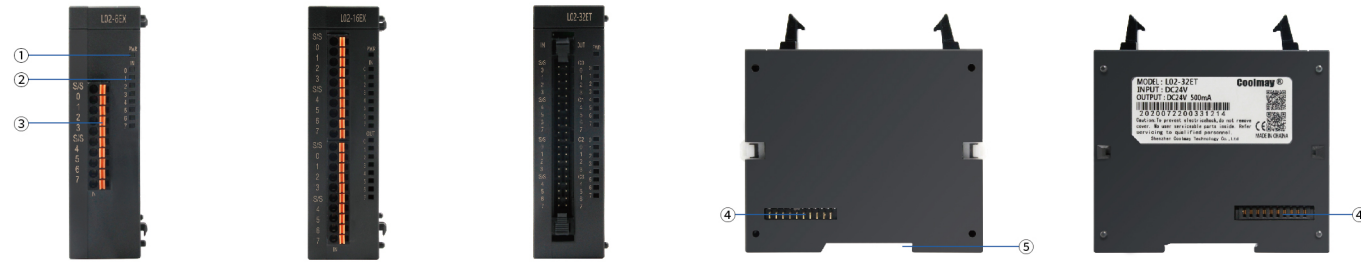

Figure 1 Product structure

1. PWR: Power indicator

2. Input and output indicators

(Among them: L02-32ET: X input: LED is red; Y output: LED is green; XY mix: LED is orange; L02-32EX: Left input: LED is red; right input: LED is green; left and right mixed: LED is orange; L02-32EYT: Left output: LED is red; right output: LED is green; left and right mixed: LED is orange)

3. Digital input and output terminal block

4. Expansion interface

5. Standard DIN rail installation

## Hardware Interface

### Input module

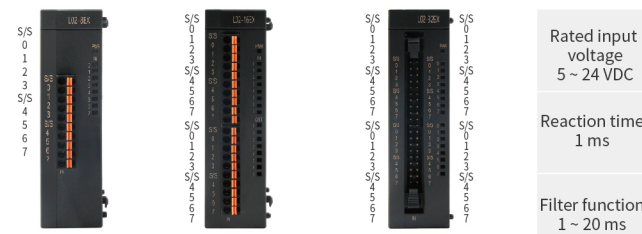

Rated input voltage  
5 ~ 24 VDC  
  
Reaction time  
1 ms  
  
Filter function  
1 ~ 20 ms

8 point Quick wiring terminal block L02-8EX	16 point Quick wiring terminal block L02-16EX	32 point High density horn socket terminal block L02-32EX
---	---	---

### Input/output module

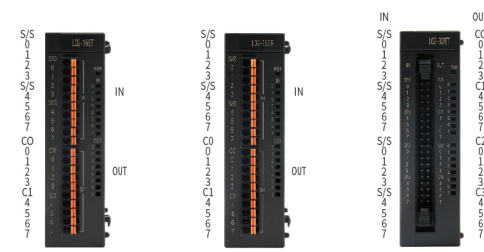

Reaction time  
1 ms (transistor)  
10 ms (relay)

16 point Quick wiring terminal block 8-point input 8-point transistor output L02-16ET	16 point Quick wiring terminal block 8-point input 8-point relay output L02-16ER	32 point High density horn socket terminal block 16-point input 16-point transistor output L02-32ET
---	--	---

### Output module



Reaction time  
1 ms (transistor)  
10 ms (relay)

8 point Quick wiring terminal block Transistor output L02-8EYT	8 point Quick wiring terminal block Relay output L02-8EYR	16 point Quick wiring terminal block Transistor output L02-16EYT	16 point Quick wiring terminal block Relay output L02-16EYR	32 point High density horn socket terminal block Transistor output L02-32EYT
---	--	---	--	---

Figure 2 DIO module

Note: S/S is the common terminal of digital input; Cx is the common terminal of digital output.

## DIO Module size

L02-8EX, L02-16EX, L02-32EX  
L02-16ET, L02-16ER, L02-32ET  
L02-8EYT, L02-8EYR, L02-16EYT, L02-16EYR, L02-32EYT

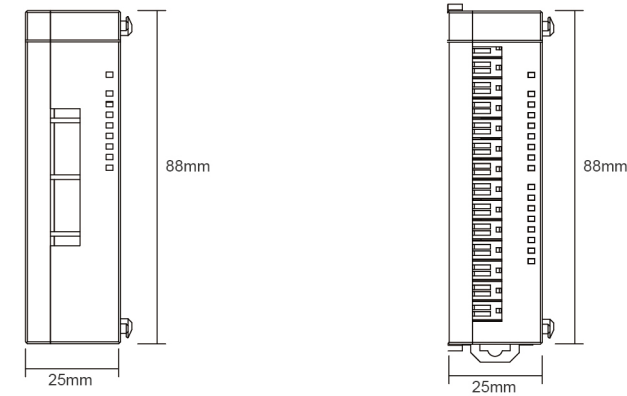

Figure 3 DIO module size diagram

## Installation Notes

### Install the snap-in buckle

Open the white buckle, align the expansion interface and push the module directly in, press the white buckle at both ends to complete the installation.



Figure 4 Snap-in buckle installation

### Rail installation method

The CPU module and the expansion modules can be directly installed on the standard rail DIN35mm without a backplane; press the rail buckle to directly lock the product on the rail.

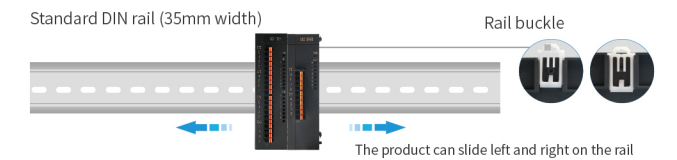

Put the module into the rail card slot and press the rail buckle to complete the installation.

Figure 5 Rail installation

## Equivalent Circuit

The input of L02 series is dual-phase optocoupler, users can choose NPN or PNP connection. Note: The common ends of the input points are all intercommunication, a module or a host can only have one wiring method, and cannot be mixed.

PLC input (X) is external power supply DC24V sink type (passive NPN), the input signal is isolated from the power supply. When using, the S/S must be connected to the 24V positive of the external power supply.

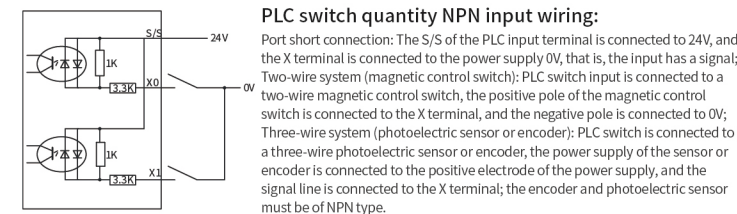

Figure 6 Input wiring diagram

PLC input (X) is an external power supply DC24V source type (passive PNP), and the input signal is isolated from the power supply. When using, the S/S must be connected to the 0V of the external power supply.

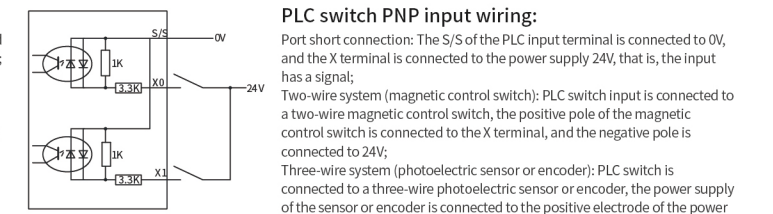

Figure 7 Input wiring diagram

Figure 8 shows the equivalent circuit diagram of the relay output module. The output terminals are in several groups, and each group is electrically isolated. The output contacts of different groups are connected to different power circuits.

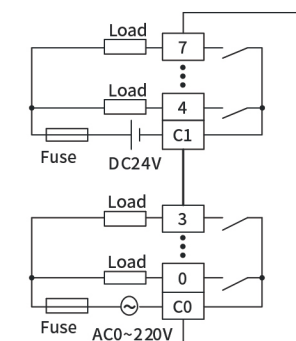

Figure 8 Relay output equivalent circuit

The PLC output equivalent circuit of the transistor output module is shown in Figure 9. It can be seen from the figure that the output terminals are in several groups, and each group is electrically isolated. The output contacts of different groups can be connected to different power circuits; the transistor output can only be used for DC 24V load circuits. The output wiring mode NPN, COM share the cathode.

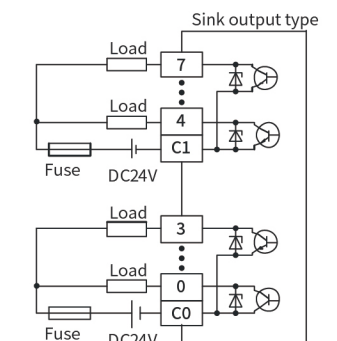

Figure 9 Transistor output equivalent circuit