

# TK Series HMI Programming Manual

Shenzhen Coolmay Technology Co., Ltd

V21.121

## Contents

Chapter 1 mView software introduction.....	1
1.1 How to install mView software.....	1
1.2 How to open mView software.....	5
1.3 Introduction to the mView software interface.....	6
Chapter 2 Introduction of mView Software Running Menu.....	8
2.1 File menu.....	8
2.1.1 New File.....	8
2.1.2 Open File.....	10
2.1.3 Save File.....	11
2.1.4 Save As File.....	11
2.1.5 Close File.....	12
2.1.6 Import.....	13
2.1.7 Export.....	13
2.1.8 Exit.....	14
2.2 Edit menu.....	14
2.2.1 Undo.....	15
2.2.2 Redo.....	16
2.2.3 Cut.....	16
2.2.4 Copy.....	16
2.2.5 Multi-Copy.....	16
2.2.6 Paste.....	17
2.2.7 Alignment.....	18
2.2.8 Size.....	19
2.2.9 Jog.....	20
2.2.10 Order.....	20
2.2.11 Setup.....	21
2.2.12 Group / Ungroup.....	22
2.2.13 Lock object / unlock object.....	22
2.2.14 Object properties.....	23
2.2.15 Copy Screen Picture.....	23
2.2.16 Save to BMP.....	24
2.2.17 Add Repository.....	25
2.3 View.....	26
2.3.1 Project management.....	27
2.3.2 Message window.....	29
2.3.3 Repository.....	29
2.3.4 Component list.....	30
2.3.5 Option(H).....	31
2.3.6 Auxiliary data of Object.....	36
2.3.7 Scale.....	36
2.3.8 Toolbar.....	38
2.4 Project.....	38

2.4.1 Screen.....	40
2.4.2 Communication.....	47
2.4.3 Tag.....	50
2.4.4 Language.....	52
2.4.5 Keyboard Define.....	54
2.4.6 Alarm.....	54
2.4.7 Password.....	56
2.4.8 Sound.....	57
2.4.9 Protection.....	58
2.4.10 Data sync.....	59
2.4.11 Record.....	59
2.4.12 Data schedule.....	64
2.4.13 Recipe.....	69
2.4.14 System Configuration.....	70
2.4.15 Macro.....	72
2.4.16 Report Manager.....	73
2.4.17 Setup (Station ID / Model).....	73
2.5 HMI.....	75
2.5.1 Syntax Check.....	76
2.5.2 On-Line Run.....	77
2.5.3 Off-Line Run.....	78
2.5.4 Stop.....	78
2.5.5 Download to HMI.....	78
2.5.6 Save To File.....	79
2.5.7 Setup.....	80
2.6 Component.....	81
2.7 Tool.....	82
2.7.1 Download HMI.....	82
2.7.2 Upload HMI.....	84
2.7.3 Update HMI OS.....	86
2.7.4 Language Selection.....	88
2.8 Window.....	89
2.9 Help.....	91
Chapter 3 mView Component Function Description.....	92
3.1 Graphic.....	92
3.1.1 Brush Settings.....	94
3.2 Static Component.....	96
3.2.1 Static Bevel/ Text.....	97
3.2.2 Scale.....	100
3.2.3 Table.....	102
3.2.4 Picture.....	103
3.2.5 Memo.....	104
3.3 Button.....	104
3.3.1 ON/ OFF Button and Switch/ Hold Button.....	104

3.3.2 Set Value/ Const Button and Inc/ Dec Button.....	107
3.3.3 Jump/ Back Button.....	110
3.3.4 Fun Button.....	111
3.3.5 Key Button.....	112
3.3.6 Set Status Button.....	114
3.3.7 Target Button.....	115
3.3.8 Data Move Button.....	116
3.3.9 Numerical set ON/ OFF button and Alternate / Hold type button.....	117
3.4 Display.....	121
3.4.1 Lamp.....	122
3.4.2 Numeric Display.....	123
3.4.3 Text Display.....	125
3.4.4 Alarm String.....	127
3.4.5 Time/Date.....	129
3.4.6 Progress Bar.....	131
3.4.7 Bar/ Float Bar.....	132
3.4.8 Meter.....	133
3.4.9 Dynamic Picture.....	134
3.4.10 Path Picture.....	135
3.4.11 Dynamic Lamp.....	137
3.4.12 Path Lamp.....	139
3.4.13 Trend Graph.....	139
3.4.14 Historical Trend.....	145
3.4.15 Record Table.....	146
3.4.16 Alarm Display/ Alarm Count Display/ Current Alarm Display.....	149
3.4.17 Status Polygon.....	151
3.4.18 Graph.....	153
3.4.19 XY Graph.....	155
3.4.20 QR code.....	157
3.4.21 Pipe Line.....	159
3.5 Edit.....	159
3.5.1 Multiple Status Edit.....	160
3.5.2 Numeric Entry.....	162
3.5.3 Text Entry.....	168
3.5.4 Password Edit.....	169
3.5.5 Track Bar.....	170
3.5.6 Scroll bar.....	171
3.5.7 List box.....	172
4. Display: refer to section 3.5.5.Chapter 4 Project management.....	173
4.1 Screen management.....	174
4.1.1 Dialog box screen.....	175
4.1.2 Case of dialogue box.....	177
4.2 Link management.....	184
4.2.1 ID and station number.....	187



4.3 Tag management.....	188
4.3.1 Tag management case.....	188
Chapter 5 Language management.....	191
5.1 Add, edit, delete languages.....	191
5.2 Multi-language and component cases.....	198
Chapter 6 Alarm management.....	203
6.1 Alarm case.....	207
7.1 Component setting.....	223
7.2 Screen settings.....	224
7.3 Password screen setting.....	225
Chapter 8 Sound Management.....	227
Chapter 9 Data Synchronization Management.....	230
Chapter 10 Recipe Management.....	233
10.1 Recipe use cases.....	236
Chapter 11 Macro Types and Grammar.....	246
11.1 Types of macros.....	246
11.2 Macro Editor.....	249
11.3 Introduction to Macro Syntax.....	250
11.3.1 Data format, operator, command list.....	250
11.3.2 Instructions.....	253
11.4 Introduction to Macro Operator Syntax.....	256
11.4.1 Operator syntax.....	256
11.4.2 Set operator syntax.....	257
11.4.3 Data format setting of variable data.....	257
11.4.4 Setting the data format setting for calculation.....	257
Chapter 12 Macro Function.....	259
12.1 Introduction to calculation functions and syntax.....	259
12.1.1 Function column table.....	259
12.1.2 Introduction to Function Syntax.....	260
12.2 Introduction to register related functions and syntax.....	262
12.2.1 List of register functions.....	262
12.2.2 Introduction to Function Syntax.....	262
12.3 Introduction to string related functions and syntax.....	267
12.3.1 List of string functions.....	267
12.3.2 Introduction to String Function Syntax.....	267
12.4 Introduction to Mathematical Calculation Related Functions and Grammar.....	274
12.4.1 A column table of mathematical calculation related functions.....	274
12.4.2 Introduction to Mathematical Calculation Related Function Syntax.....	275
12.5 Introduction to Time-Related Functions and Syntax.....	279
12.5.1 A column of time-related functions.....	279
12.5.2 Introduction to Time-Related Function Syntax.....	279
12.6 Introduction to Functions and Syntax of Data Conversion.....	281
12.6.1 List of register functions.....	281
12.6.2 Introduction to Function Syntax.....	281

12.7 Introduction to Functions and Syntax Related to Calculation Check Code.....	284
12.7.1 Column table related functions of calculation check code.....	284
12.7.2 Introduction to the Function Syntax Related to Calculation Check Code.....	284
12.8 Introduction to Communication Related Functions and Syntax.....	287
12.8.1 A column table of communication-related functions.....	287
12.8.2 Introduction to Communication Related Function Syntax.....	288
Chapter 13 Description of Macro Communication.....	289
Appendix 1 Definition of mView Project Editing Keyboard.....	291
Appendix 2 List of mView System Preset Variables.....	293
1 System preset variables.....	293
2 The usage of internal pointer variable V.....	298
Appendix 3 mView Scale Frequency Table.....	300
Appendix 4 Instructions for Using Operation Variables.....	301
Appendix 5 Function Description of Multiple Intelligent Connected Machines of HMI.....	304
Appendix 6 Function Description of Embedded Numerical Value Display in String.....	306
Appendix 7 List of Communicable Controllers.....	309
Appendix 8 TK Series HMI Storage Data export Operation Instruction.....	311
Appendix 9 HMI modbus RTU Communication Instruction.....	322
Appendix 10 Instructions of Coolmay TK series HMI communicating with other band PLC.....	333
Appendix 11 HMI program simulation and download.....	359
11.1 Program simulation.....	359
11.1.1 On-Line Run.....	360
11.1.2 Off-Line Run.....	361
11.2 Program download and update O.S. version.....	361
11.2.1 Download to HMI.....	362
11.2.2 Save as HMI program.....	363
11.2.3 Update HMI OS.....	365
11.3 Program upload.....	367
11.3.1 Upload HMI program.....	367
Appendix 12 HMI USB penetrating function.....	370
Appendix 13 Version Change Record.....	374

## Chapter 1 mView software introduction

### 1.1 How to install mView software

(Please go to the official website : [WWW.COOLMAY.COM](http://WWW.COOLMAY.COM) to download the latest version)

This chapter will detaily introduce the installation process of mView software.

#### ■Hardware requirements

The basic hardware requirements for installing mView editing software are as follows:

1. Personal computer host: It is recommended to use a CPU of 80486 or higher.
2. Memory: It is recommended to use more than 128MB RAM to expand the memory.
3. Hard disk: The hard disk must have more than 100MB of space.
4. Display: General VGA or SVGA display card.
5. Mouse: Use a Windows compatible mouse.
6. Printer: Use a Windows compatible printer.

Before you install it, please check whether the computer hardware is as above or higher. In order to avoid problems with hardware incompatibility, please use the recommended specifications as much as possible. If you have any questions, please contact our customer service.

#### ■ Software source

You can enter our company's website [WWW.COOLMAY.COM](http://WWW.COOLMAY.COM) to obtain the latest version of the software.

■ Installation steps (take the simplified Chinese version of mView as an example), note that "mView \*\*\*\*" software version is subject to the official website.

Select mView 13802.exe in the installer window to start the installer and start the installation;

●Set the storage path of the installation file, select the default, or enter the address, or click the [Browse ...] button to select the address, and then click the [Next] button;

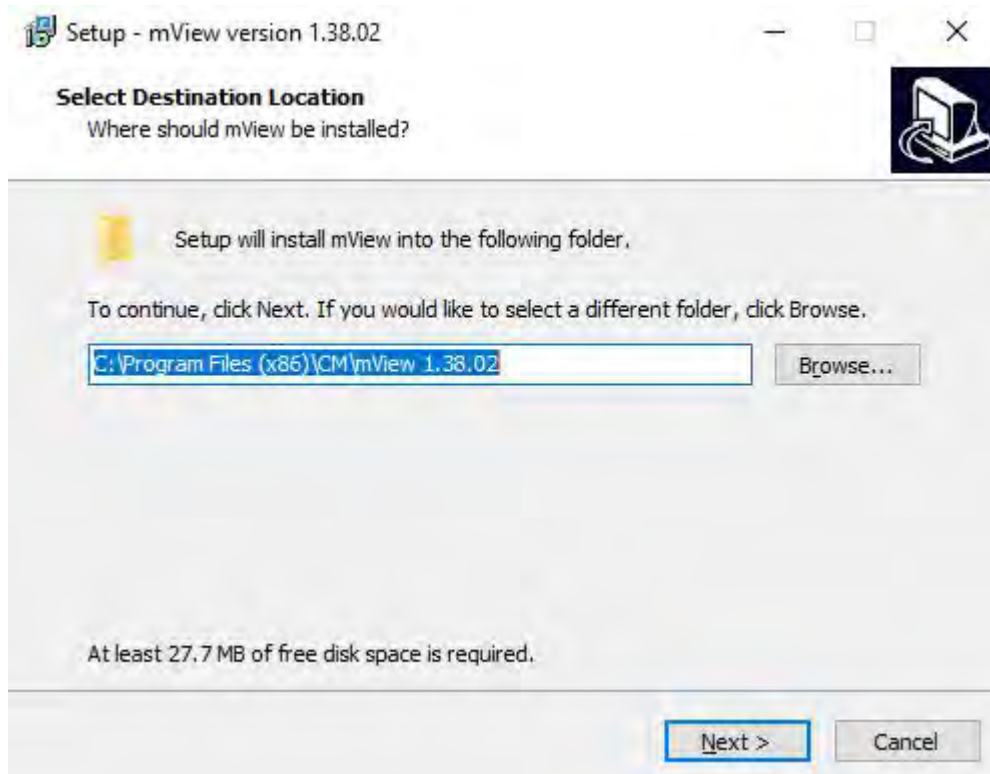

- Set the name of the saved folder. It is recommended to select the default and click the [Next] button directly.

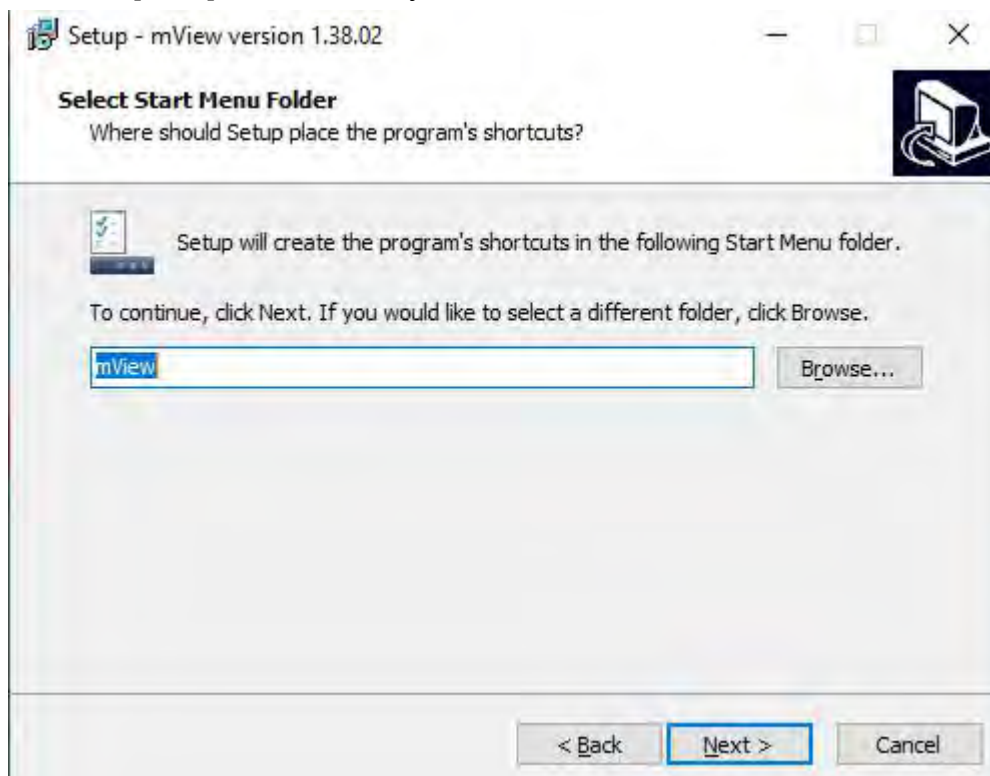

- Choose whether to create a desktop shortcut icon, and then click the [Next] button.

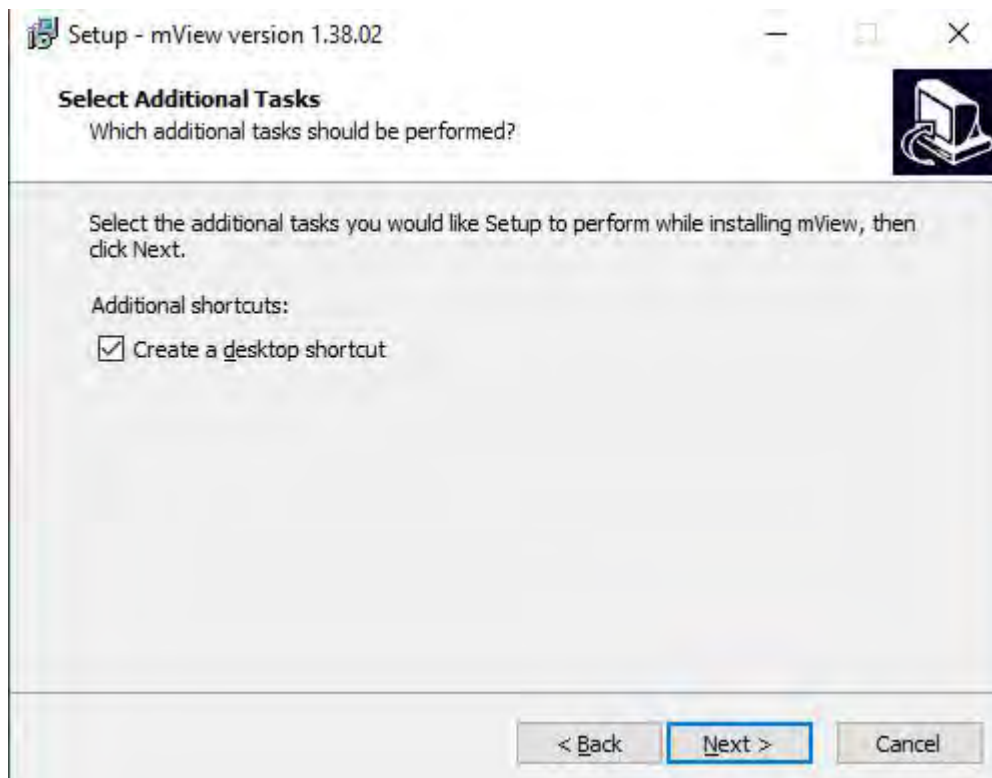

- Confirm the installation path and other installation information, and then click the [Install] button to install.

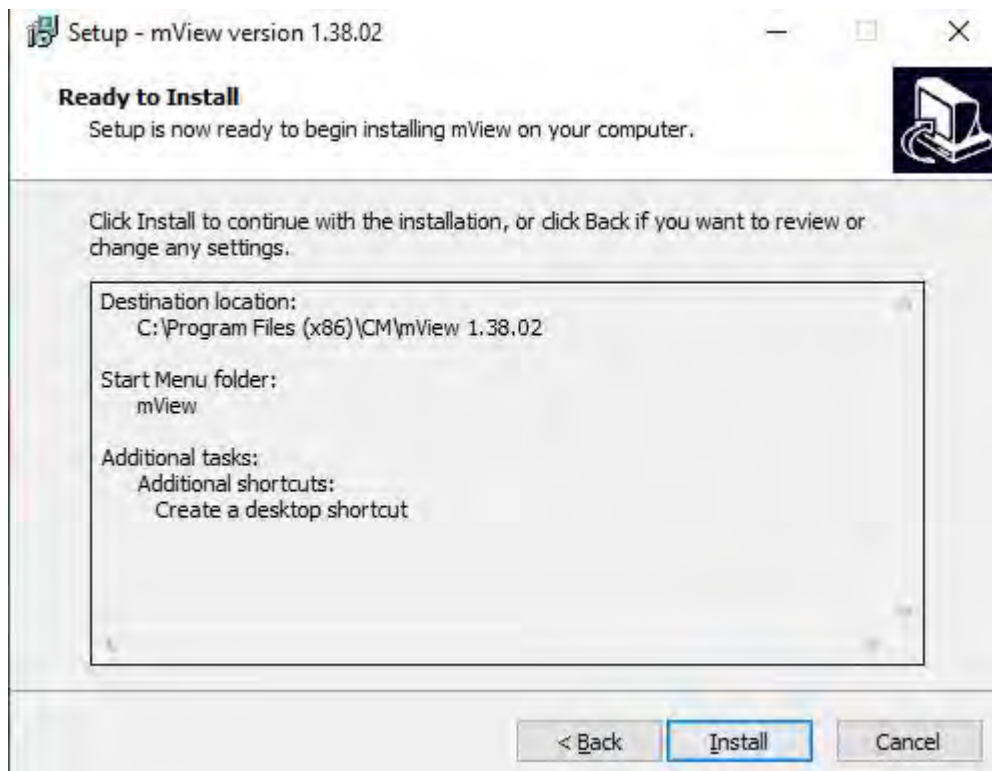

- The installation process is shown below:

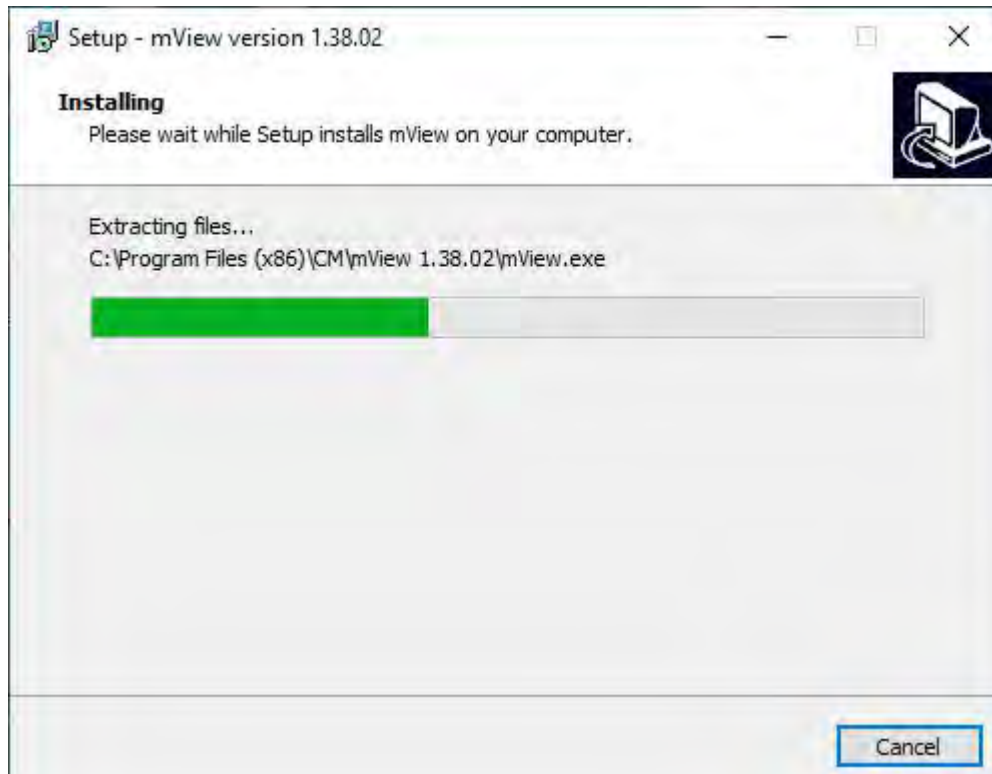

- Click [Next] to install the driver wizard

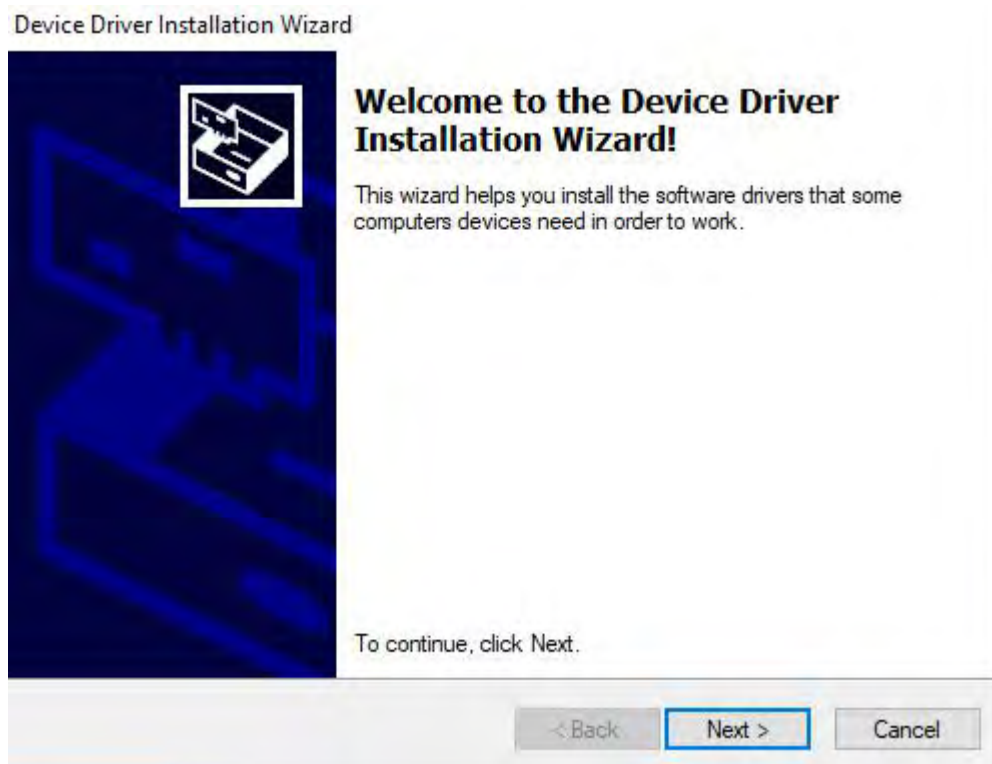

- The driver installation is completed



## Device Driver Installation Wizard



- Finally, click [Finish] to complete the installation.

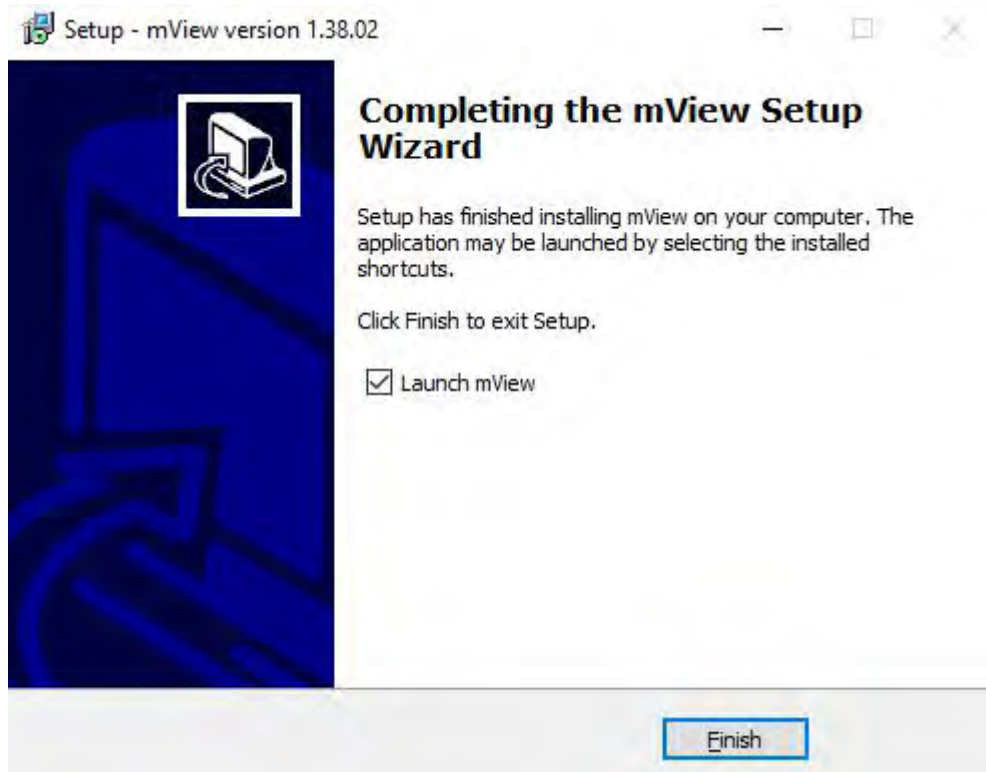

## 1.2 How to open mView software

After the installation of mView software is completed, a shortcut will be

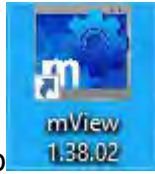

placed on the desktop. At the same time, the corresponding mView program group has been added to the Windows start menu:

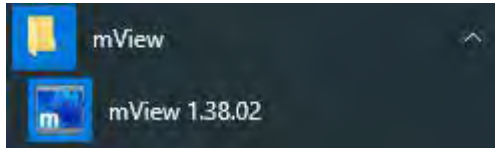

Choose one of the above two methods to open the mView programming software. When the application is started, a startup window will pop up, as shown in the following figure. After the software is opened, it will be checked according to the menu bar [View]->[Option...]->[File]->Program start automatically open file, to determine whether to start the last project file when the software is opened, or not to open any file.



### 1.3 Introduction to the mView software interface

mView editing interface layout:



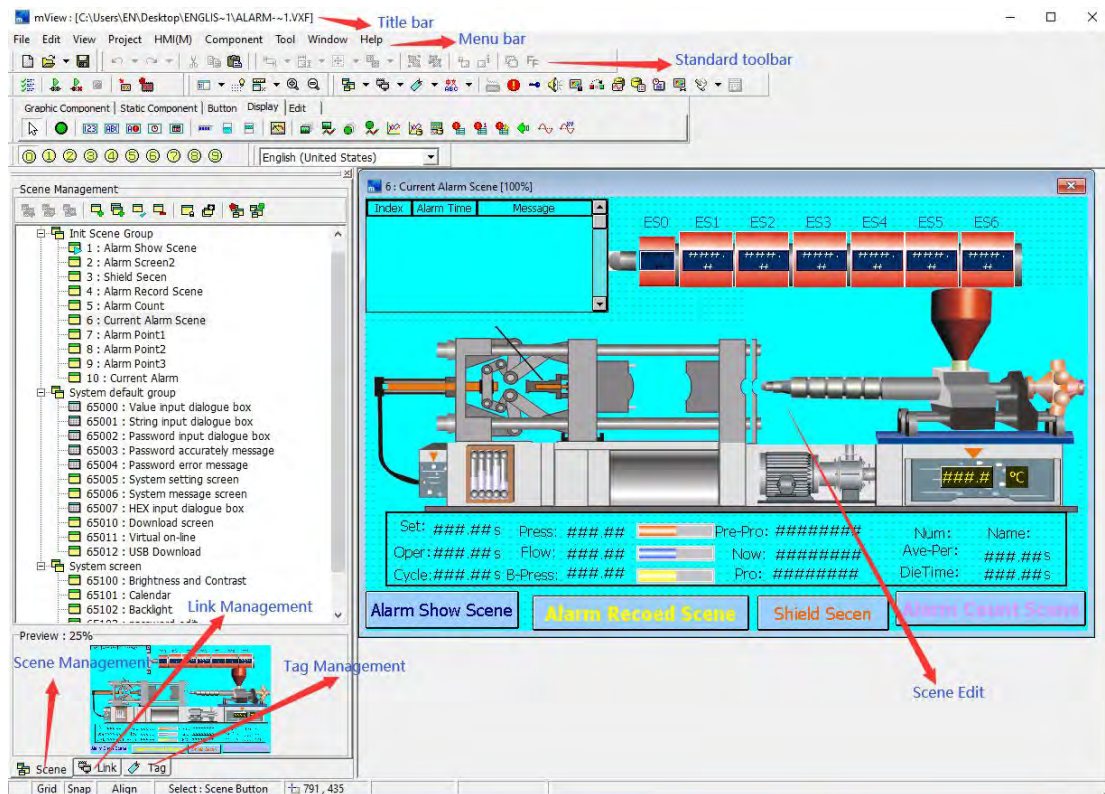

- **Title bar:** Displays the currently opened project path and file name, window number, and window name.
- **Menu bar:** A menu that displays various commands of CoolMayView. These menus are pull-down menus.
- **Standard toolbar:** Shortcut buttons for placing some commands. Corresponding buttons and editing tools for displaying files, editing, printing and other functions.
- **Design components:** Command buttons for component objects.
- **Screen management:** The management window of the screen used by the project.
- **Communication management:** engineering designers to manage, set up a window to communicate with PLC or other serial devices.
- **Label management:** Set labels for system variables and external variables to facilitate users to quickly find the corresponding variables.
- **Status bar:** Displays the current operation status, human-machine interface parameters, and communication equipment.

## Chapter 2 Introduction of mView Software Running

### Menu

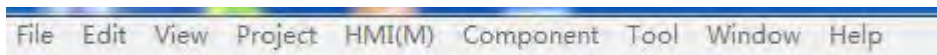

#### 2.1 File menu

Use the mouse to directly click [File], or use the keyboard to press [ALT] + [F], the [File] drop-down menu appears, as shown in Figure 2-1.1. In order to facilitate users to quickly select, shortcut icons are also provided in the toolbar, as shown in Figure 2-1.2.

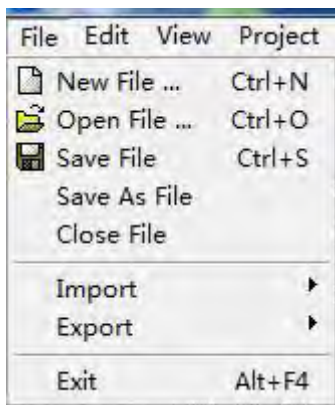

2-1.1



2-1.2

File toolbar

(1)	New File...
(2)	Open File...
(3)	Save File

##### 2.1.1 New File...

To create a new project, you can directly click [New File] under [File] menu, Or click the icon  in the toolbar, Or use the hot key Ctrl + N set by the system. The dialog box shown below is displayed:

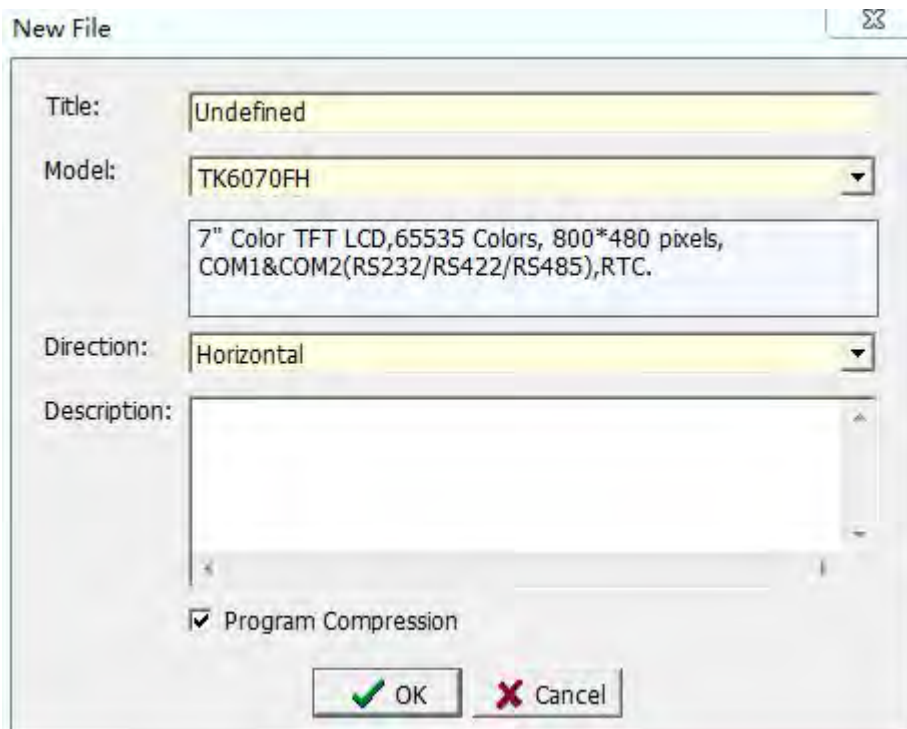

Title: Enter the name of the new project;  
Model: select the model of the human-machine interface (HMI);  
Direction: select whether the editing screen is displayed horizontally or vertically;  
Description: Enter a help description for the newly created project, or choose not to enter it.

After completing the project-related information input, click the [OK] button to enter the communication information setting dialog box, as shown in the following figure. For specific settings, please refer to section 2.4.2 Communication Management.

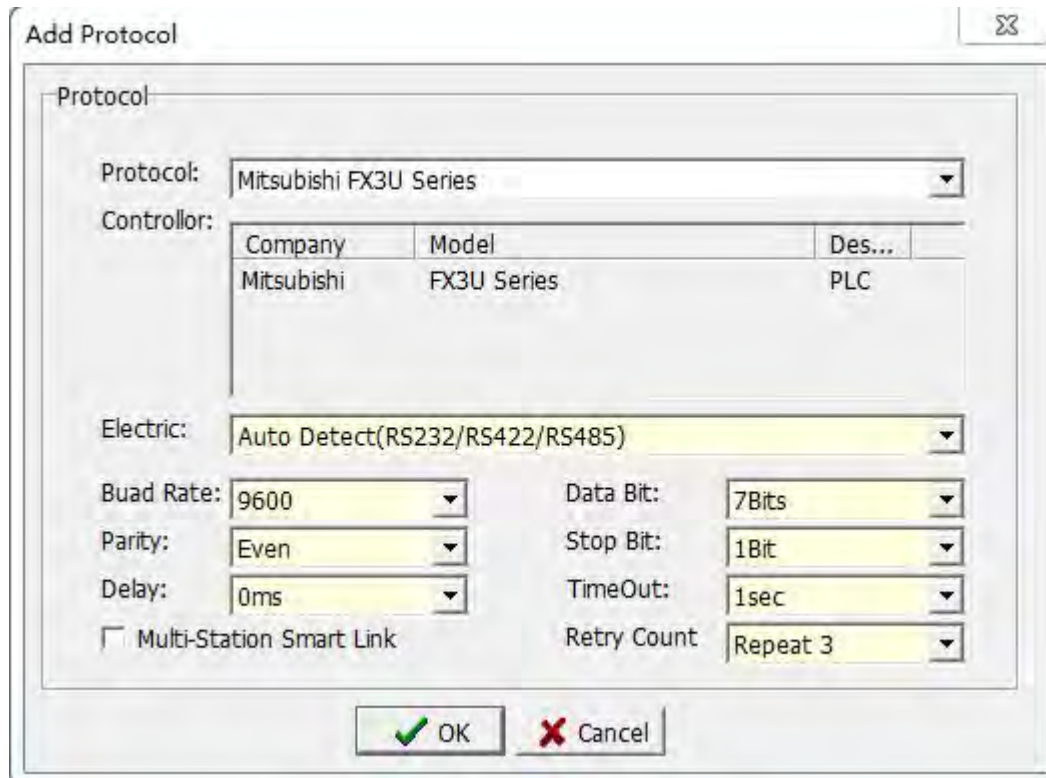

### 2.1.2 Open File...

To open an existing file, you can directly click [Open File...] under [File] menu, Or click the icon  in the toolbar, Or use the hot key Ctrl + O set by the system. The dialog box shown below is displayed:

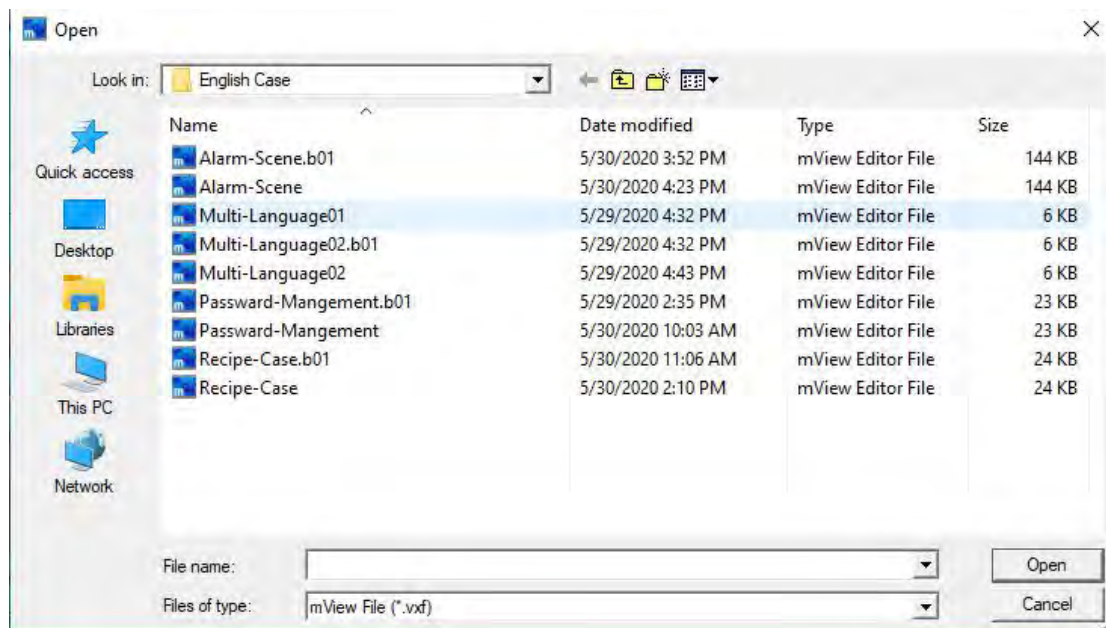

Select the file with the suffix vxf that needs to be opened, press the [Open] button, or double-click the selected project file with the mouse.

### 2.1.3 Save File

To save the currently edited project to disk, you can directly click [Save File] under [File] menu, Or click the icon  in the toolbar, Or use the hot key Ctrl + S set by the system.

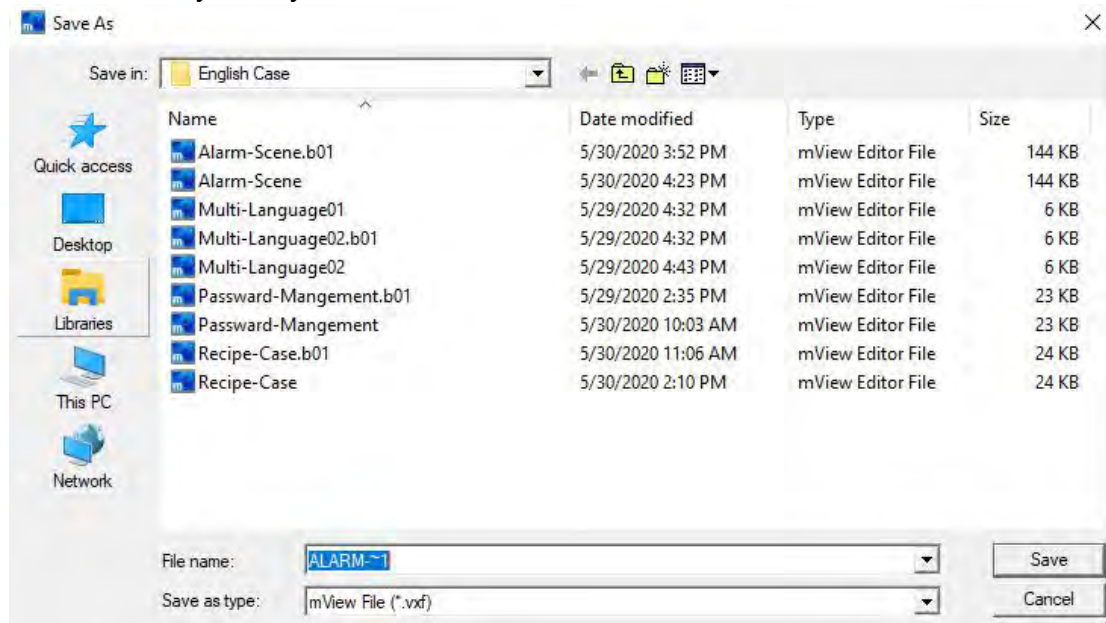

When saving a new project, the save vxf file box as shown above will pop up, enter the name of the project you want to save in the file name field, and click the [Save] button. If the project has already been saved, pressing [Save] will not display any dialog box, but only save the latest information of the current project.

### 2.1.4 Save As File

Save the currently edited screen data to another specified file name on the disk. This item can only be selected by [Save As File] under [File] Whether it is a new project or an old project, the Save New File dialog box will pop up:



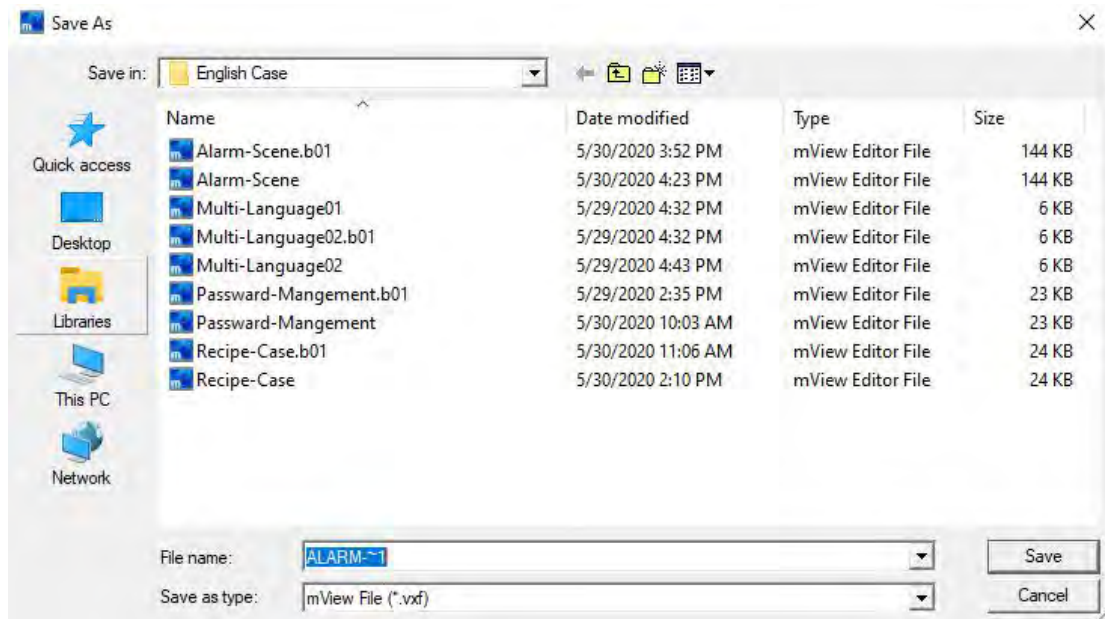

After entering the new project name, click [Save] to save the project as a new project file.

### 2.1.5 Close File

Close the currently edited project file. This item can only be selected by [Close File] under [File]. If the project file is modified, the following dialog box will pop up to save the modified project file.



Click the [Yes] button to save the newly modified file, and then exit the current project file;

Click the [No] button to save the newly modified file, and then exit the current project file;

Click the [Cancel] button to exit the dialog box and do nothing with the newly modified file;

## 2.1.6 Import

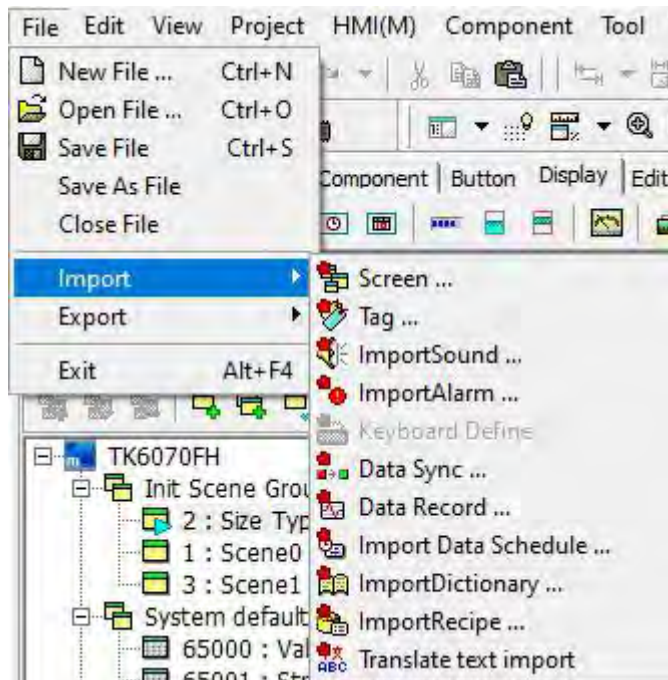

## 2.1.7 Export



### 2.1.8 Exit

End the application and save the project, select the [Exit] option under the menu [File], Or click the button  in the main window. If the project has changed, or has not been saved, the following dialog box will appear:

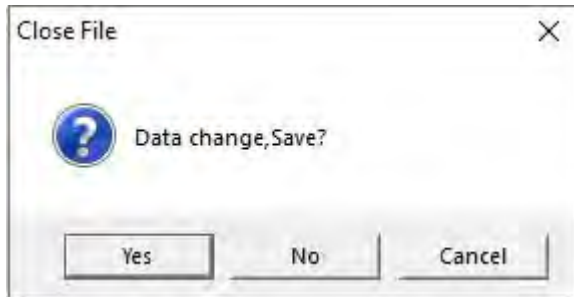

Click the [Yes ] button to save the newly modified file, and then close the current software program;

Click the [No ] button to save the newly modified file, and then close the current software program;

Click the [Cancel] button to exit the dialog box and do nothing with the newly modified file;

## 2.2 Edit menu

Use the mouse to directly click [Edit], or use the keyboard to press [ALT] + [E], the drop-down menu of [Edit] appears, as shown in Figure 2-2.1. In order to facilitate users to quickly select, shortcut icons are also provided on the toolbar, as shown in Figure 2-2.2.



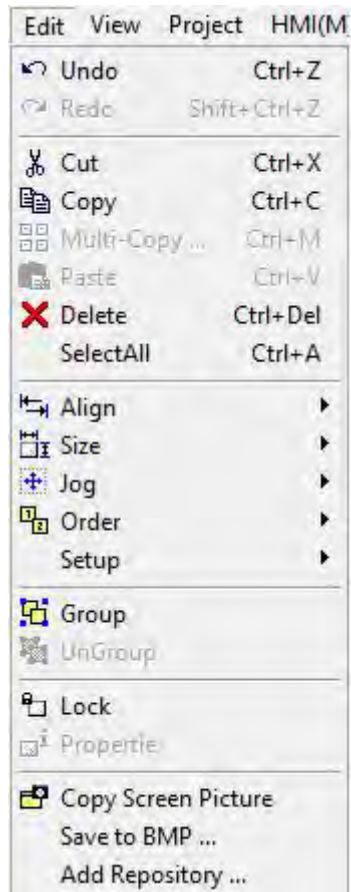

2-2.1



2-2.2

(1)	Undo 【Ctrl+Z】	(9)	Order
(2)	Redo 【Shift+Ctrl+Z】	(10)	Group
(3)	Cut 【Ctrl+X】	(11)	UnGroup
(4)	Copy 【Ctrl+C】	(12)	Lock
(5)	Paste 【Ctrl+V】	(13)	Propertie
(6)	Alig	(14)	Same bevel
(7)	Size	(15)	Same font
(8)	Jog		

### 2.2.1 Undo

To undo the last edited action, you can select the [Undo] option under [Edit], Or click the icon  in the toolbar, Or use the hot key Ctrl + Z set by the system.

### 2.2.2 Redo

To restore the previous undo action, you can select the [Redo] option under [Edit], Or click the icon  in the toolbar, Or use the hot key shift + Ctrl + Y set by the system.

### 2.2.3 Cut

Cut the selected components to paste in the new location. You can select the [Cut] option under [Edit], Or click the icon  in the toolbar, Or use the hot key Ctrl + X set by the system.

### 2.2.4 Copy

If the components used are the same, you can use the copy operation to make the same components. You can select the [Copy] option under [Edit], Or click the icon  in the toolbar, Or use the hot key Ctrl + C set by the system.

### 2.2.5 Multi-Copy

Select a specific component to make multiple copies, you can select the [Multi-Copy] option under [Edit], or use the hot key Ctrl + M set by the system. After clicking, the selection box as shown below will appear:

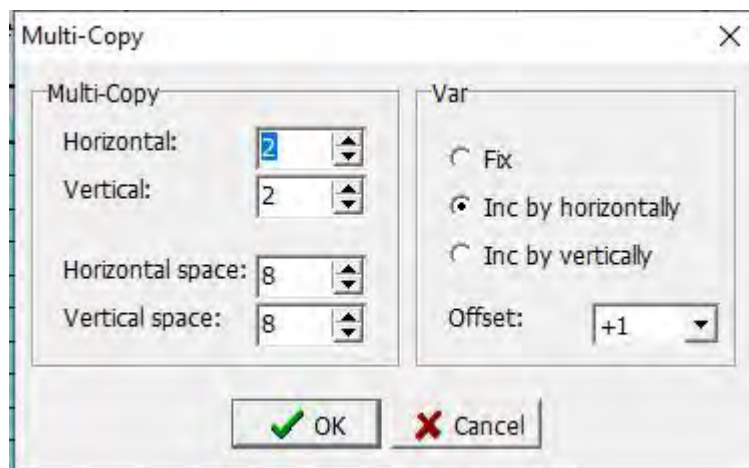

#### Multiple copy settings

Number of horizontal copies: Set the number of copies in the horizontal direction.

Number of vertical copies: Set the number of copies in the vertical direction.

Horizontal interval points: Set the distance between horizontal elements.

Vertical spacing points: Set the distance between vertical components.

### Component variable modification

Uncorrected: No processing is performed on the copied components.

Increasing in the horizontal direction: Set the order in which the device reads the soft elements to increase horizontally and then vertically.

Vertical increment: set the order in which the device reads the device to increase vertically first and then horizontally.

Address offset value: Set the number of increments of the device reading device value.

- Example of multiple copying: select the horizontal number = 2 and the vertical number = 3 above the number of copies

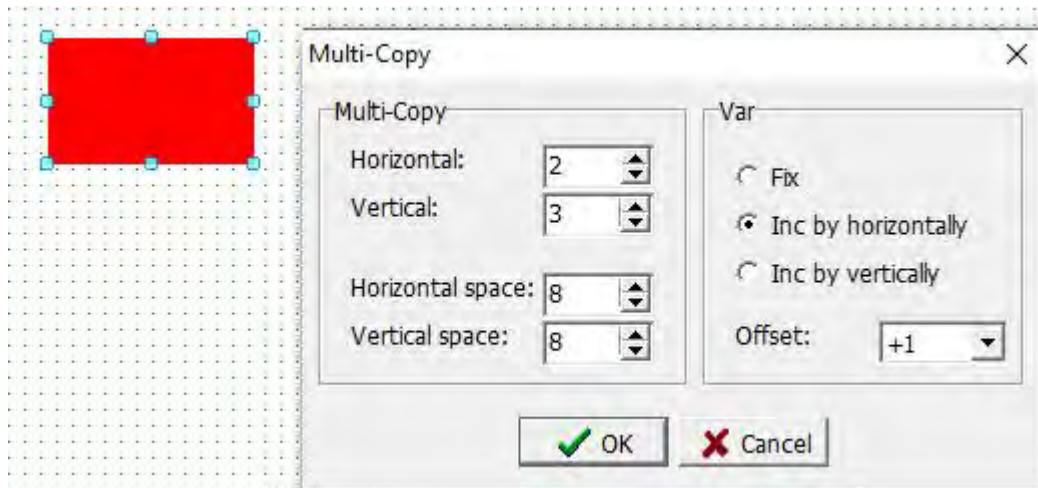

- Example of multiple copy: Click [OK] to complete multiple copy. The result is shown below:

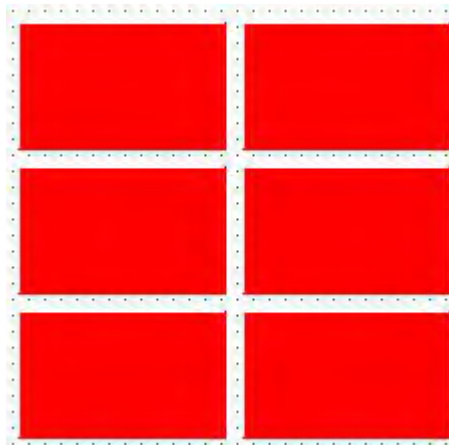

### 2.2.6 Paste

To insert the copied or cut components, you can select the [Paste] option under [Edit], Or click the icon  in the toolbar, Or use the hot key Ctrl + V set by the system.

## 2.2.7 Alignment

Select the components that need to be aligned, and there must be more than two components. Click [Align] under [Edit], as shown below, Or click the

icon  in the toolbar.

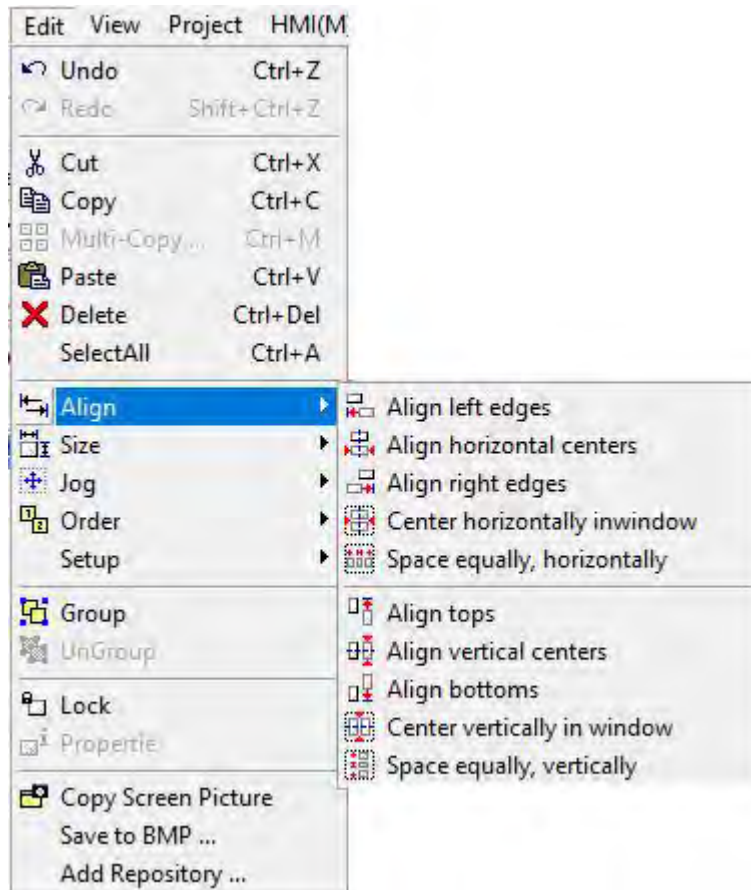

In this example, select [Upper Edge Alignment]. This alignment method uses the top edge of the reference object as the object alignment. As shown below:

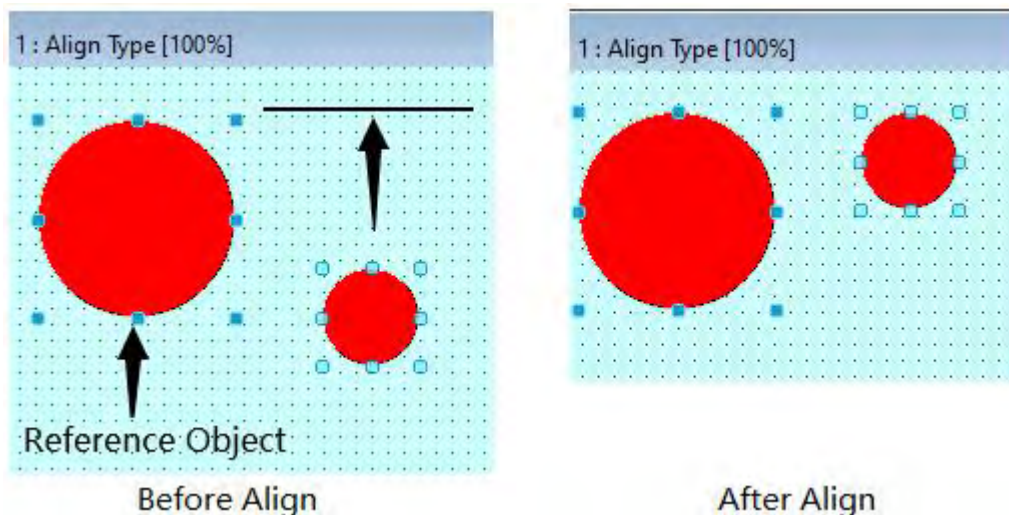

### 2.2.8 Size

Select the components that need to be set with the same size. There must be more than two components. Click [Size] under [Edit], as shown below, Or

click the icon  in the toolbar.

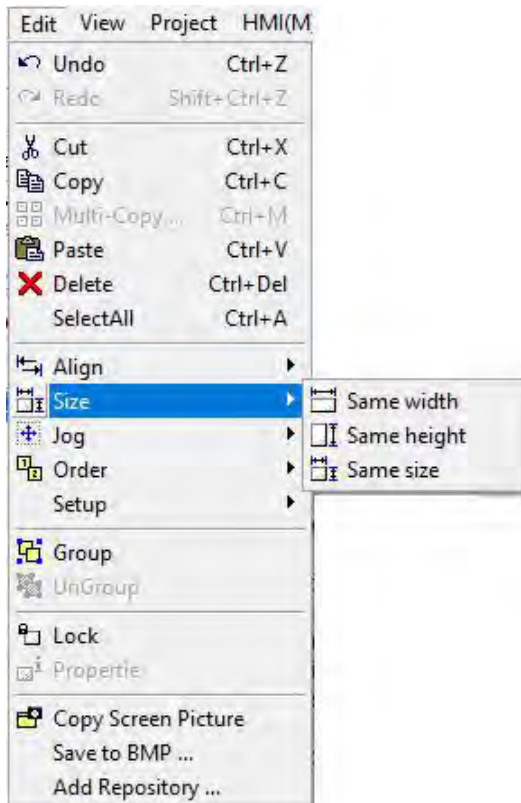

When selecting more than two graphic components, in order to speed up the editing of the component size, you can use this alignment function to first select the graphic component whose size you want to modify, and then select which component is the main one. Then select [Same Width] or [Same Height] or [Same Size]. As shown in the following figure [same width]:

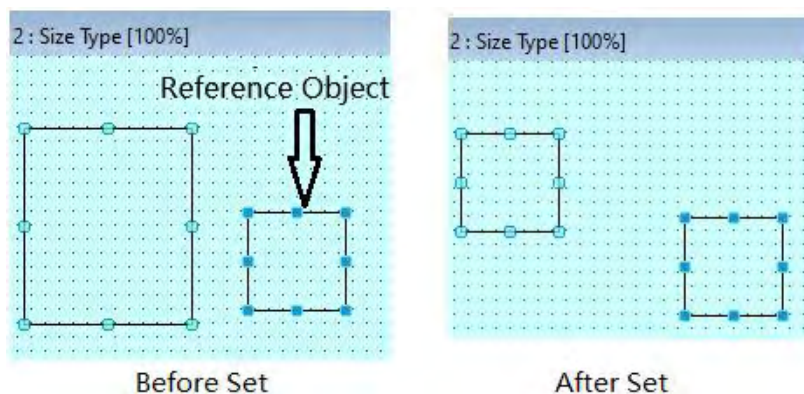



## 2.2.9 Jog

Use this function to finely move the position of the selected component. After selecting the component, click [Fine Adjustment] in the [Edit] menu as shown below, Or click the icon  in the toolbar, You can move the selected component position up, down, left, and right in detail, or you can use the keyboard up, down, left, and right keys (fine adjustment), or you can use Shift + keyboard up, down, left, and right keys (with a grid point) Main), Ctrl + keyboard up, down, left, right button (change the selected component size fine-tuning) for rapid movement and size adjustment.

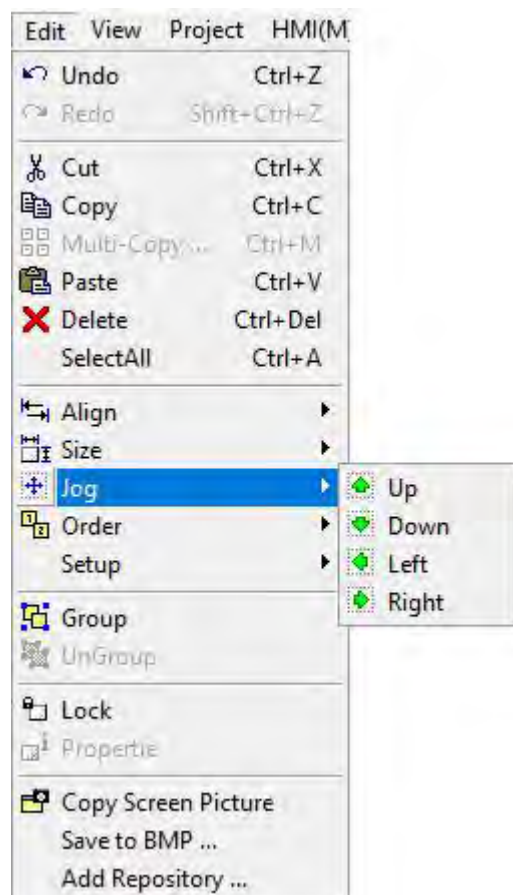

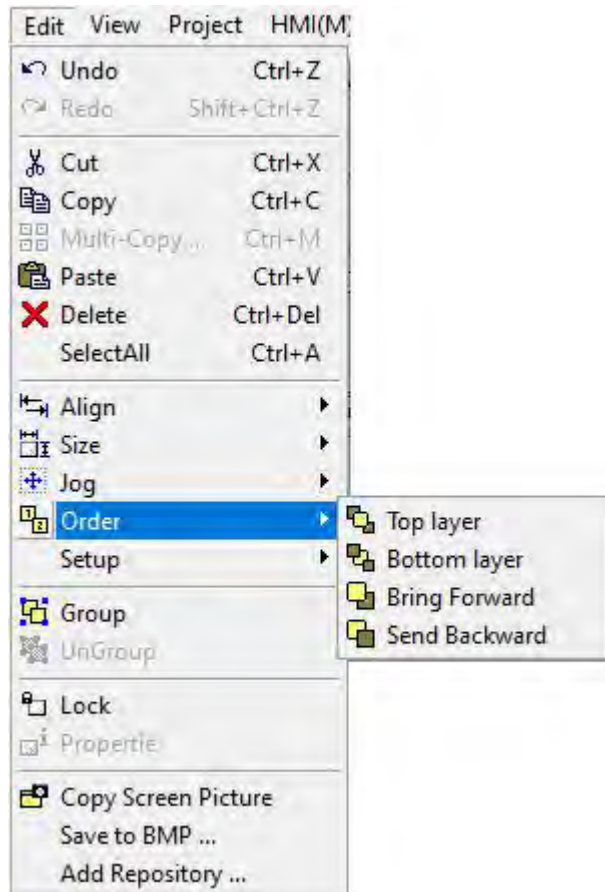

## 2.2.10 Order

After selecting the component, click [Sequence] in the [Edit] menu as shown below, Or click the icon  in the toolbar, When the components overlap, the components can be moved to the upper layer, the next layer, the uppermost layer, and the lowermost layer according to requirements.



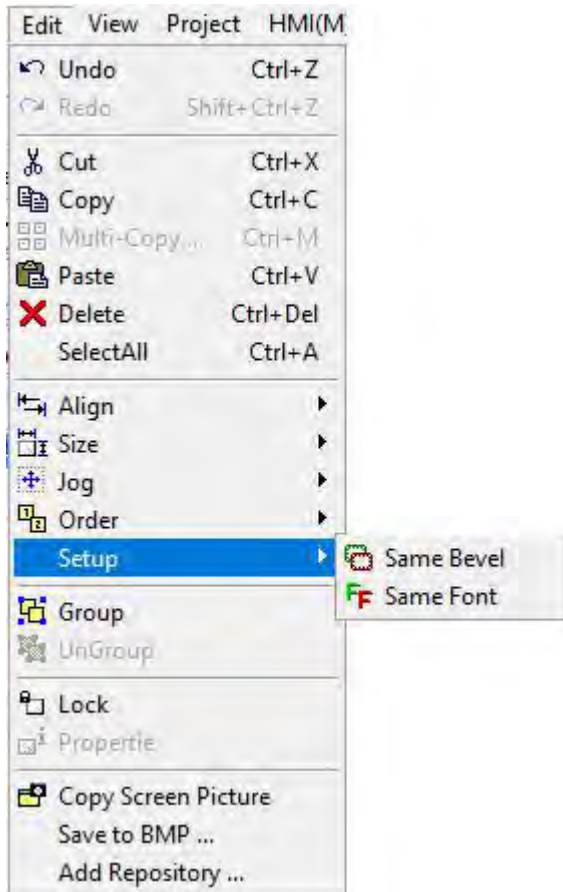

### 2.2.11 Setup

Select the component components that need to be set with the same border and the same font. There must be more than two components. Click [Setup] under [Edit] as shown in the figure below. Or click  or  icon in the toolbar, You can set the border or font of multiple components to be the same as the border or font of the selected reference component.





### 2.2.12 Group / Ungroup

When selecting multiple components, when moving or copying, in order to be able to edit quickly and easily. You can click [Group / Ungroup] under the [Edit] menu, Or click  or  icon in the toolbar.

To group multiple components into one component, namely [Group], you can also use the hot key [G]. Select the previously assembled components and click [Cancel Group] to separate them, or use the hot key [U].

### 2.2.13 Lock object / unlock object

After selecting one or more components, click [Lock Object] under the [Edit] menu to fix the component. The fixed component cannot be moved and its attributes cannot be modified. To release the setting, select the component to be released and click [Lock Object] under the [Edit] menu again to release.

Or click  or  icon in the toolbar to lock or unlock the component, you can also use the hot key [L] to fix or cancel.



## 2.2.14 Object properties

Since the object property window of each component is different, please refer to the detailed description in the [Chapter 3 Components] chapter of this manual.

## 2.2.15 Copy Screen Picture

Click [Copy Screen Picture] under the [Edit] menu to copy the current edit screen window, as shown in the figure below. After copying, you can paste the screen picture into drawing software or office software such as WORD to facilitate file sort out.

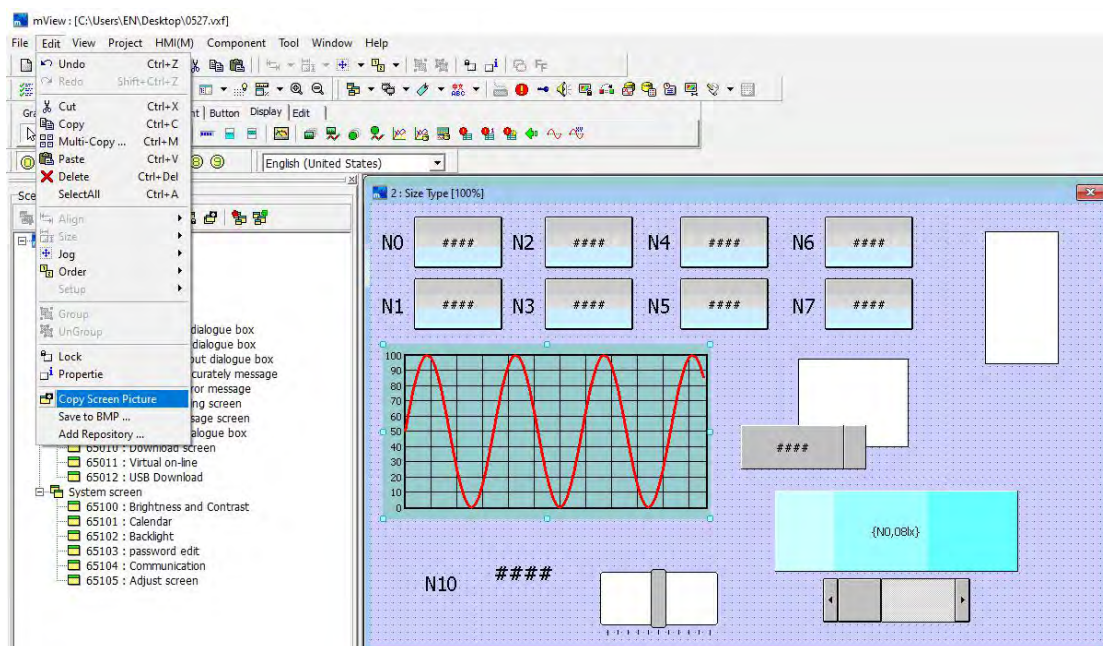

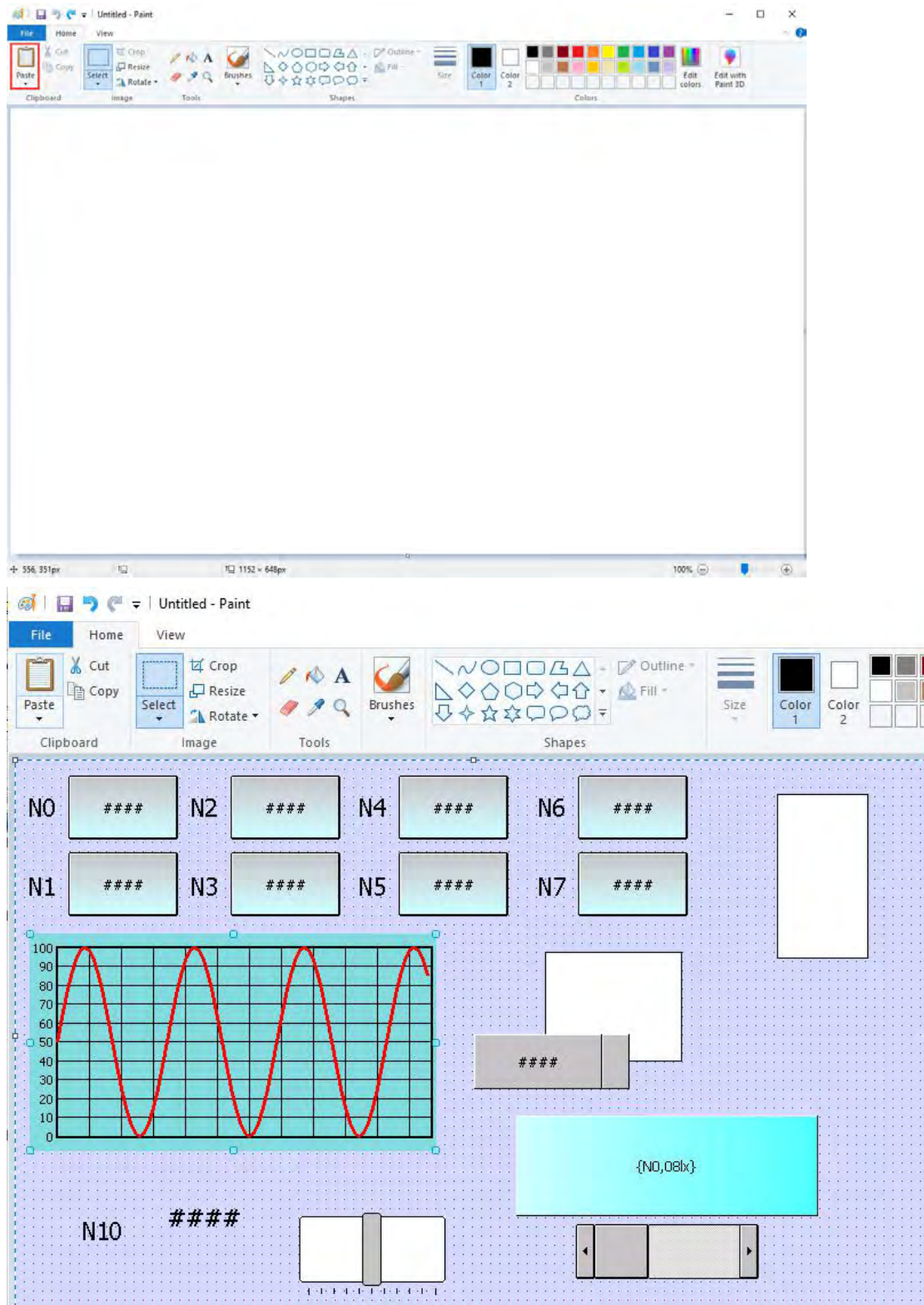

## 2.2.16 Save to BMP

After selecting the component you want to save as a picture, click [Save to BMP] under the [Edit] menu, a dialog box as shown in the figure below pops up, select the save path, enter the name of the picture to be saved, and click [Save

(S) button to save the selected component as a picture.

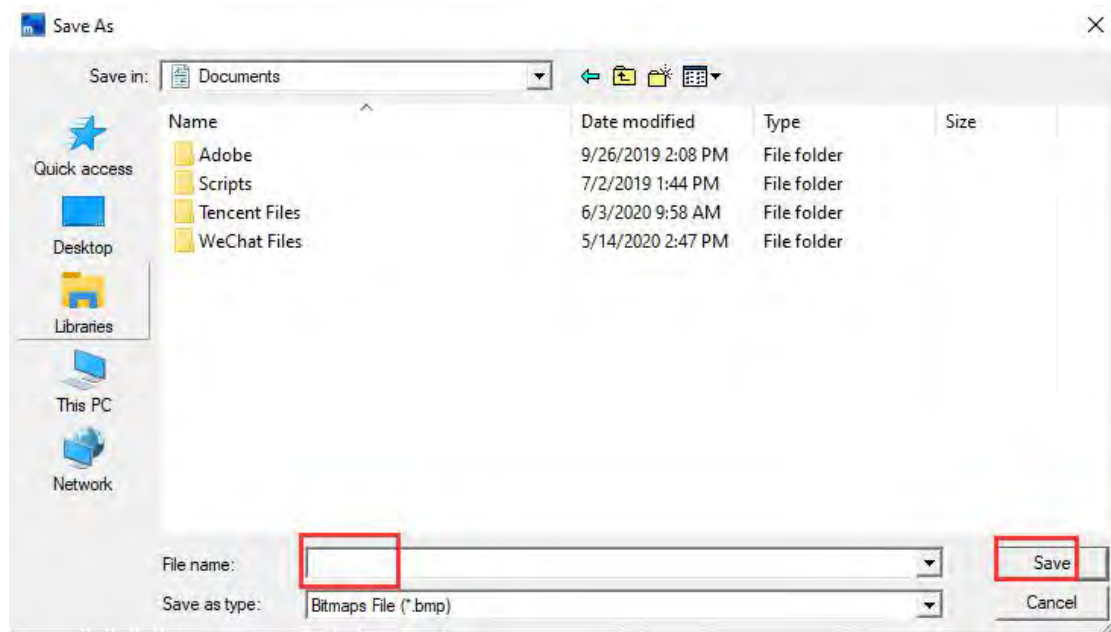

## 2.2.17 Add Repository

This function puts the component into the component library. When using it, you can open the component library and quickly select the component according to the component setting classification and name in the component library. After selecting any component, click [Edit]-> [Add Repository], the following dialog box will pop up:

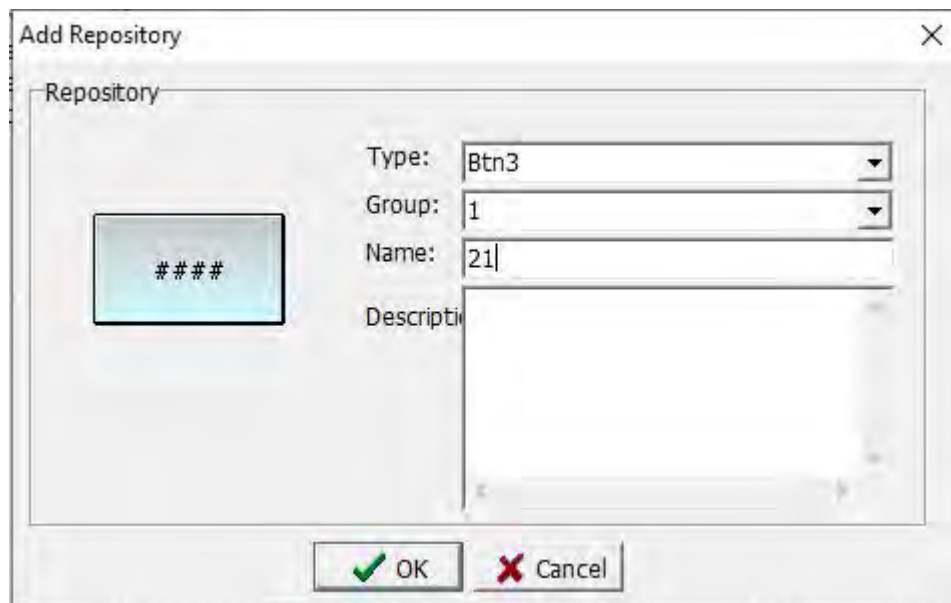

Type : Set the category of the component in the component library.

Group: Set the group of components in the category of the component library.

Name: Set the name of the component in the component library.

Description: Fill in the auxiliary description of the description component.

After the setting is completed, click the [OK] button, and the selected component will enter the software component library, as shown in the following figure:

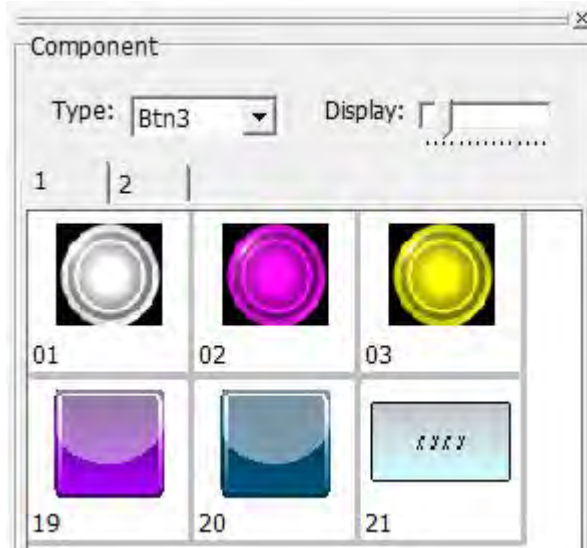

When in use, you can double-click the component directly in the component library, which can save the details such as setting the appearance font, which greatly improves the speed of program writing.

## 2.3 View

Use the mouse to directly click [View], or use the keyboard to press [ALT] + [V], the [View] drop-down menu appears, as shown in Figure 2-3.1. In order to facilitate users to quickly select, shortcut icons are also provided in the toolbar, as shown in Figure 2-3.2.

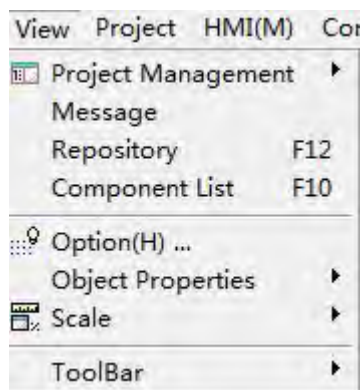

2-3.1



2-3.2



(1)	Project
(2)	Option
(3)	Scale
(4)	Zoom in
(5)	Zoom out

### 2.3.1 Project management

The project management window refers to the comprehensive display and management of the screen and communication of the current editing project. Click [Project Management] under the [View] menu, there are the following four sub-options.

**1. Scene:** After clicking scene, a window for screen management will appear on the left of the software (this window is also the default display window), or directly click [Screen] in the lower left corner of the software. The picture management window is shown in the figure below. The management window is responsible for the organization and planning of all screens of the man-machine interface. For details, refer to 4.1 Screen Management.

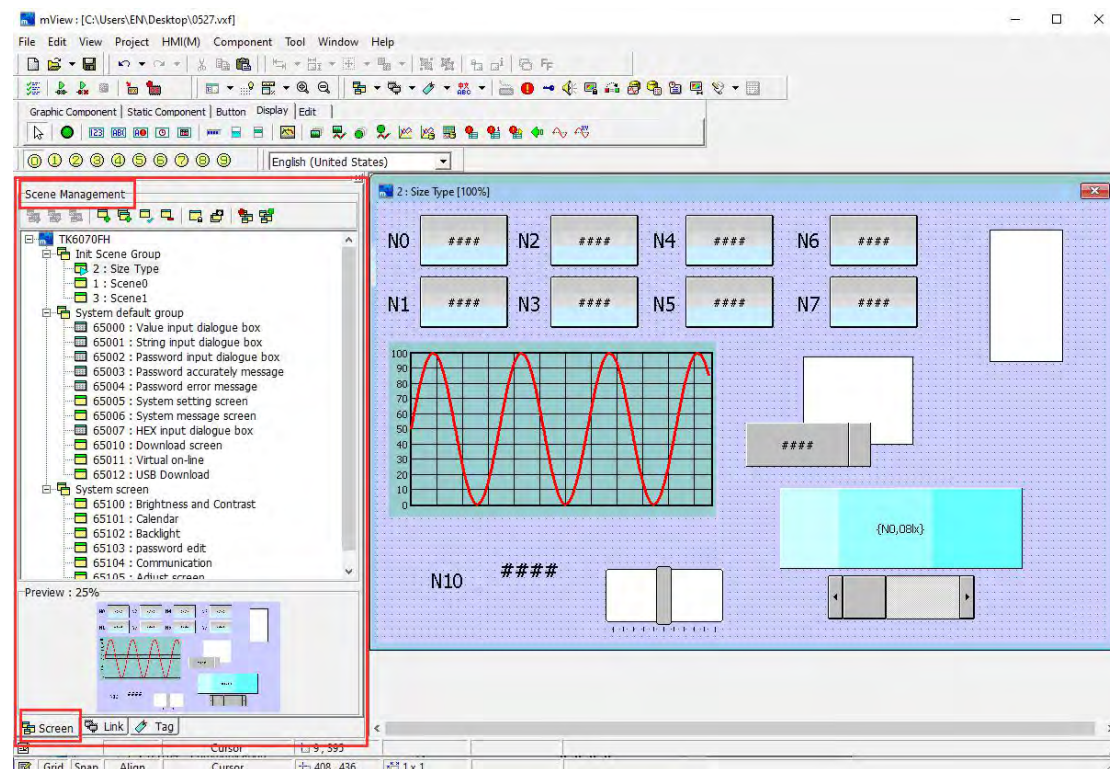

**2. Communication:** After clicking communication, a window for link management will appear on the left side of the software, or click [Link] in the lower left corner of the software. The link management window is shown in the figure below. This management window is responsible for the man-machine interface and programmable control The communication protocol and configuration settings between the PLC (PLC) or other serial communication

devices. For details, refer to 4.2 Link Management.

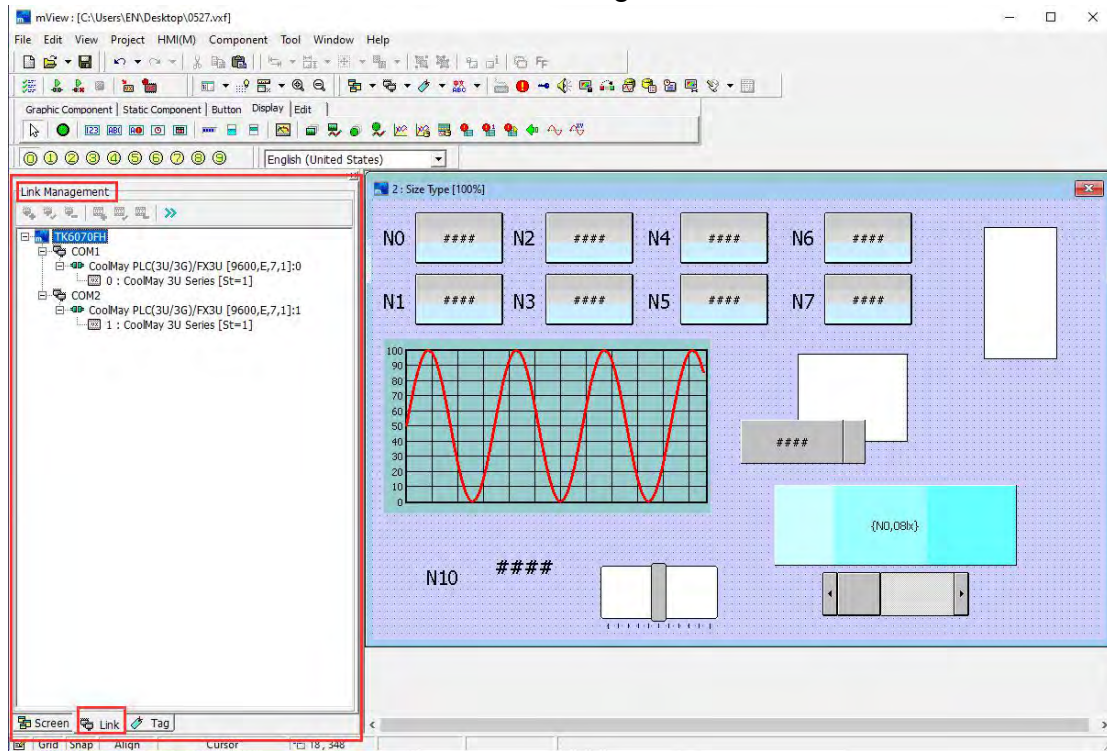

**3. Tag:** After clicking Tag, the tag management window will appear on the left of the software, or directly click [Tag] in the lower left corner of the software. The tag management window is shown in the figure below. For details, refer to 4.3 Tag Management.

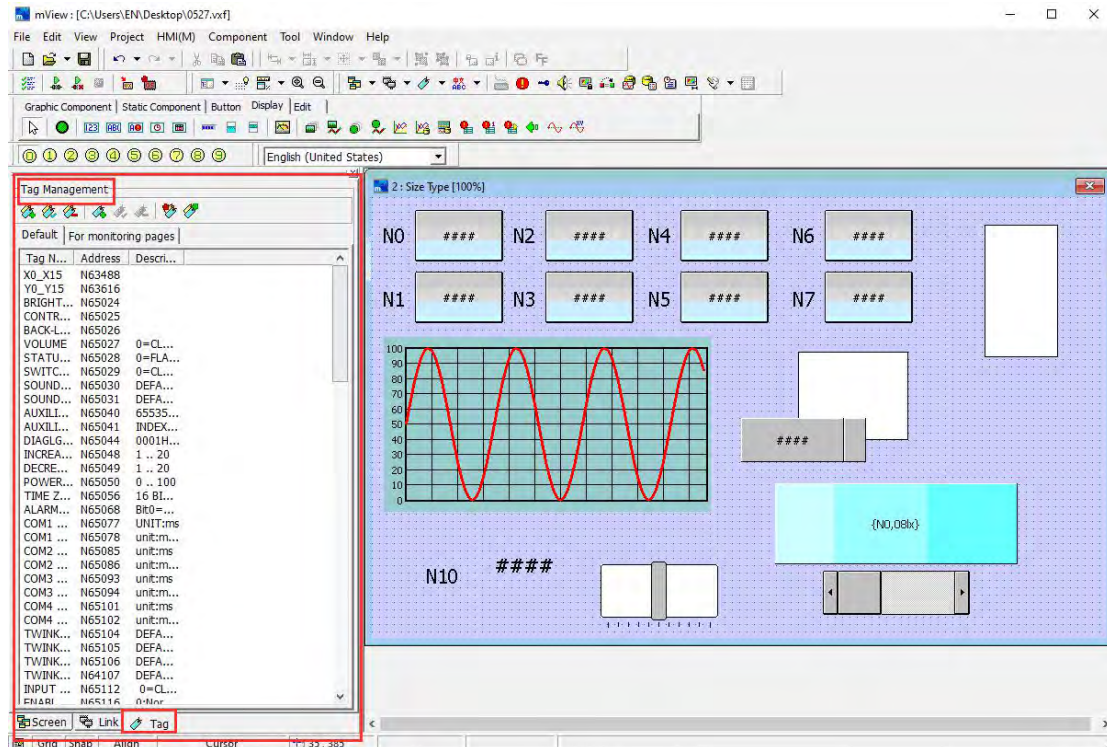

**4. Language :** After clicking Language, a dialog box for language setting as shown in the figure below will pop up. For details, please refer to Chapter 5 Language Management.



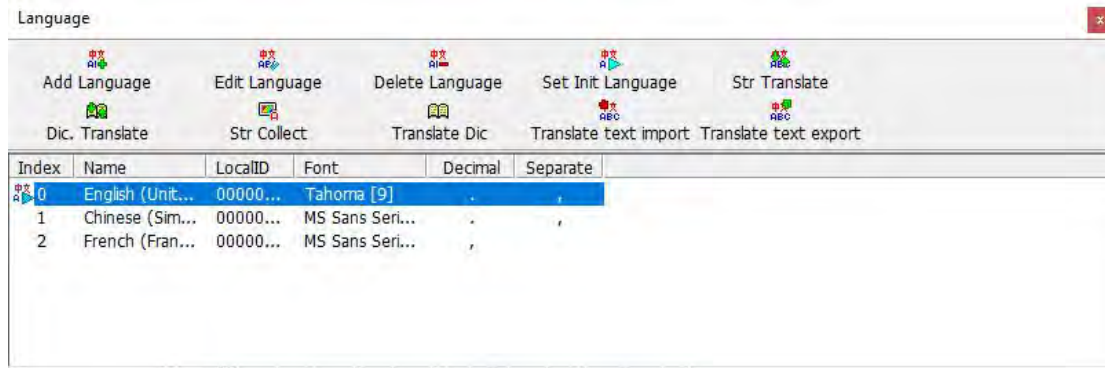

### 2.3.2 Message window

Click [Message] under the [View] menu, and the grammar check window as shown below will appear. When running, if there is a setting error, it will be displayed in the syntax check window for program modification.

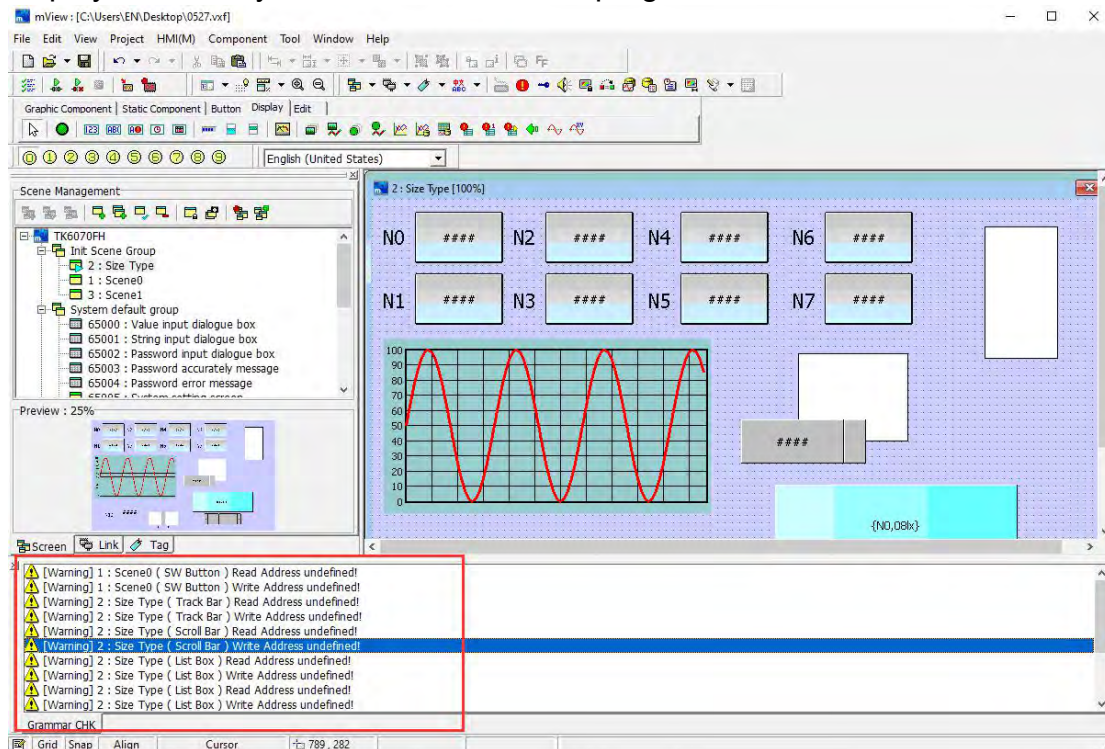

### 2.3.3 Repository

Click [Repository] under the [View] menu, or use the keyboard shortcut [F12], the repository as shown below will appear. When performing interface programming, use this window to conveniently access the required components.

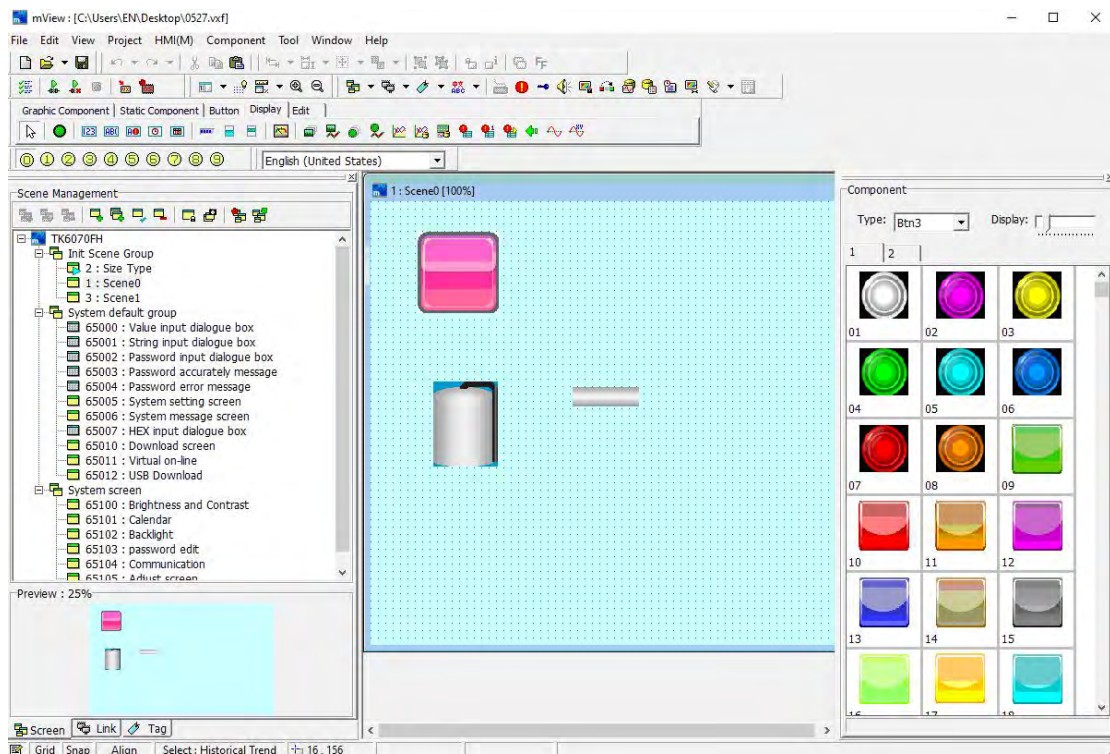

When in use, select the component classification as required. As shown in the figure below, select the component to be used in each category, double-click the component, and the component is placed in the right screen window.

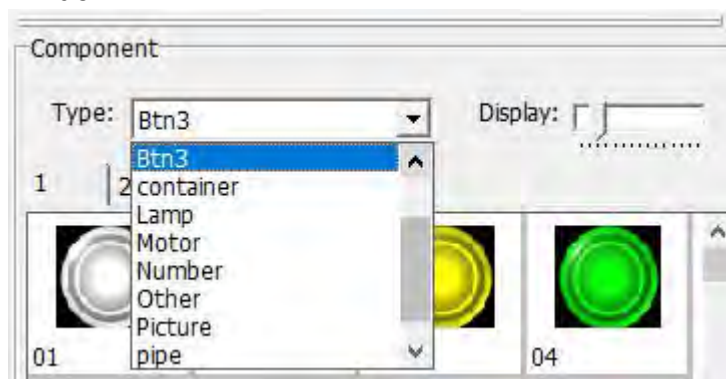

### 2.3.4 Component list

Click [Component List] under the [View] menu, or use the keyboard shortcut [F10], and the component list window as shown below will appear. In the component list window, you can intuitively see all the components used in the current screen window.



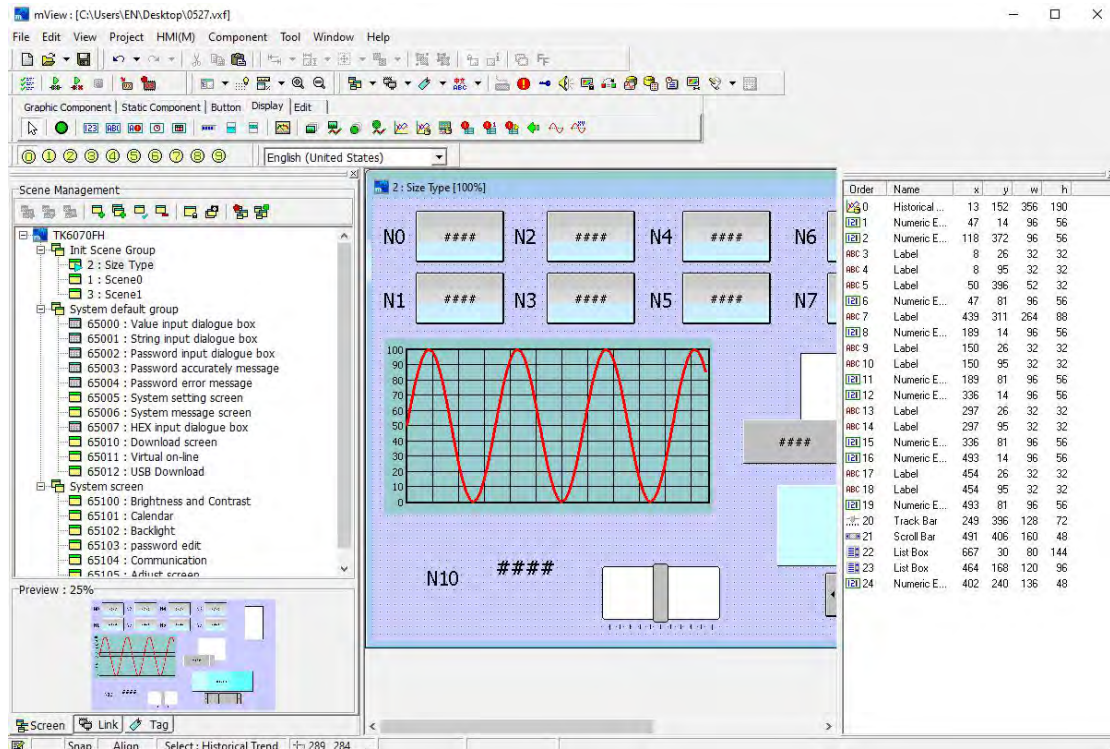

### 2.3.5 Option(H)

Click [Option(H)] under the [View] menu, and the auxiliary setting dialog box as shown in the figure below will appear.

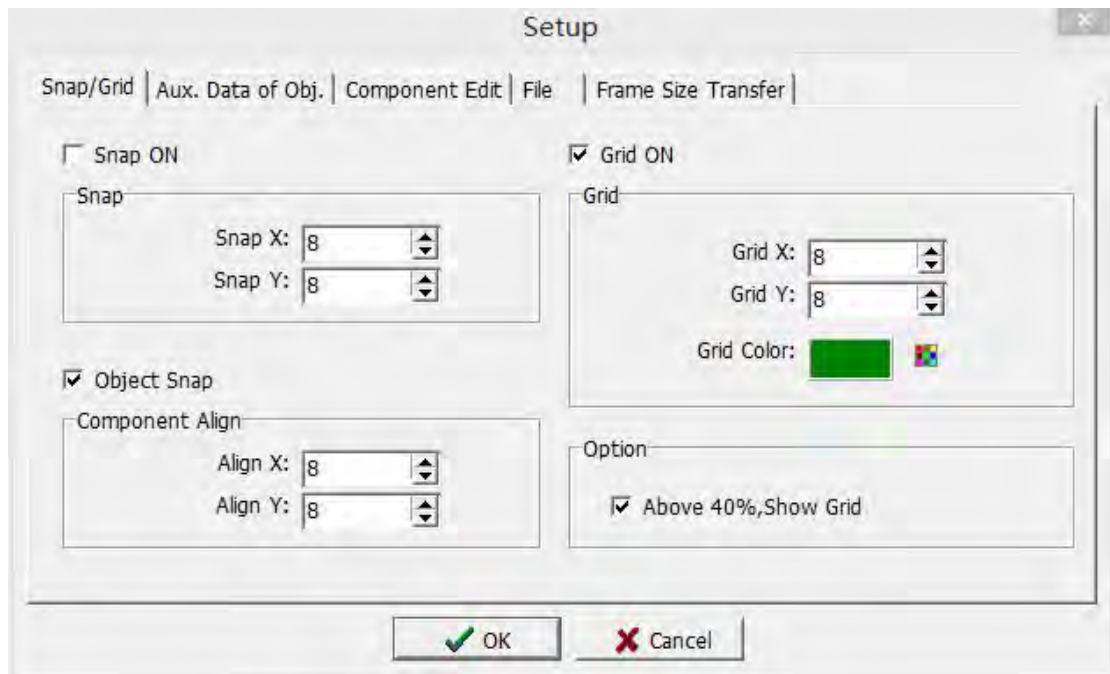

**Snap/Grid:** The dialog box is shown above

**Snap ON:** This option refers to whether the upper left corner of the set element must be on the set grid when editing the screen.

In the snap combo box, the distance between the snap is set separately in the

XY direction, and the allowable setting range is 1 to 32. It is recommended that the setting be consistent with the grid XY direction.

Grid ON: This option refers to whether to display background auxiliary grid when editing the screen.

In the grid combo box, set the spacing of grid points in the XY direction, and the allowed range is 1 ~ 32.

Grid color: Set the display color of the grid.

Object snap: This option refers to whether to display the alignment guideline when the moving element is aligned up, down, left, and right when editing the screen.

In the object alignment spacing combo box, set the alignment spacing in the XY direction, and the allowable setting range is 1 ~ 32. The alignment guideline is displayed when the distance between the moved component and other components is equal to the set alignment distance.

Option: This option sets whether the screen displays a background grid when the screen display ratio is greater than 400%.

**Aux. Data of Obj.:** The settings dialog box is shown below

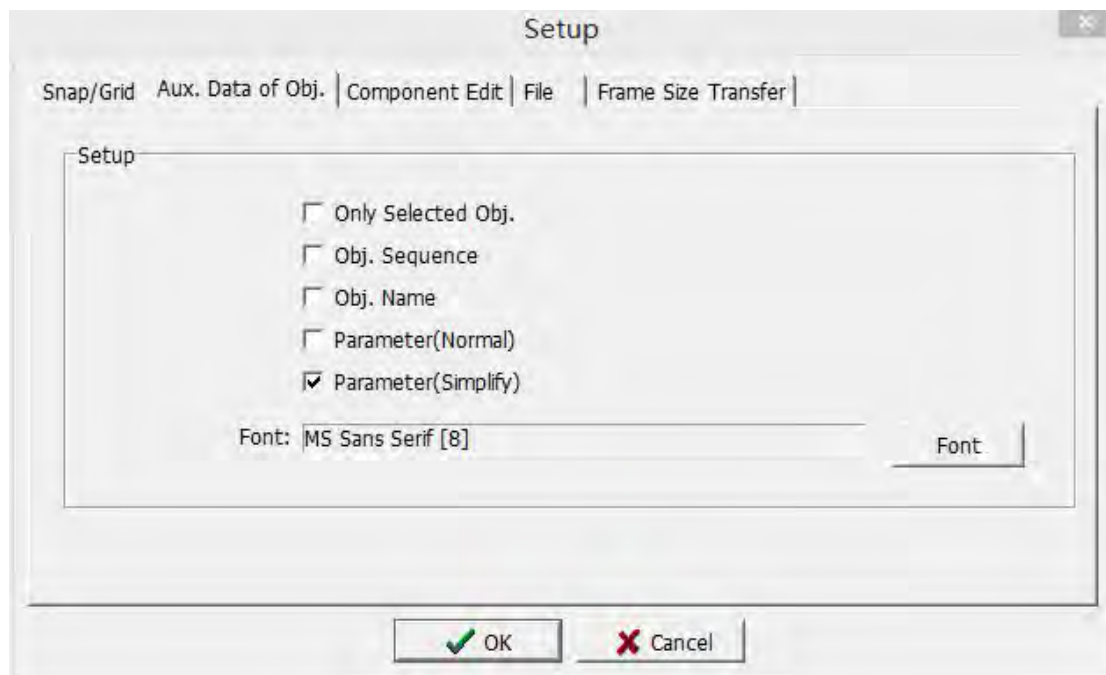

Only Selected Obj.: Check this option, the following options are only displayed for the selected components, otherwise all components in the screen are displayed.

Obj. Sequence: Check this option, the order of each component will be displayed on the screen.

Obj. Name: Check this option, the name of each component will be displayed on the screen.

Parameter (Normal): Check this option, the screen will display the complete information of the variables corresponding to each component.

Parameter (Simplify): Check this option, the simple information of the variables

corresponding to each component will be displayed on the screen

Display font: Click the [Font] button to pop up a font selection dialog box, as shown in the figure below, you can set the default font, font style, size, effect, underline, and color of the displayed font.

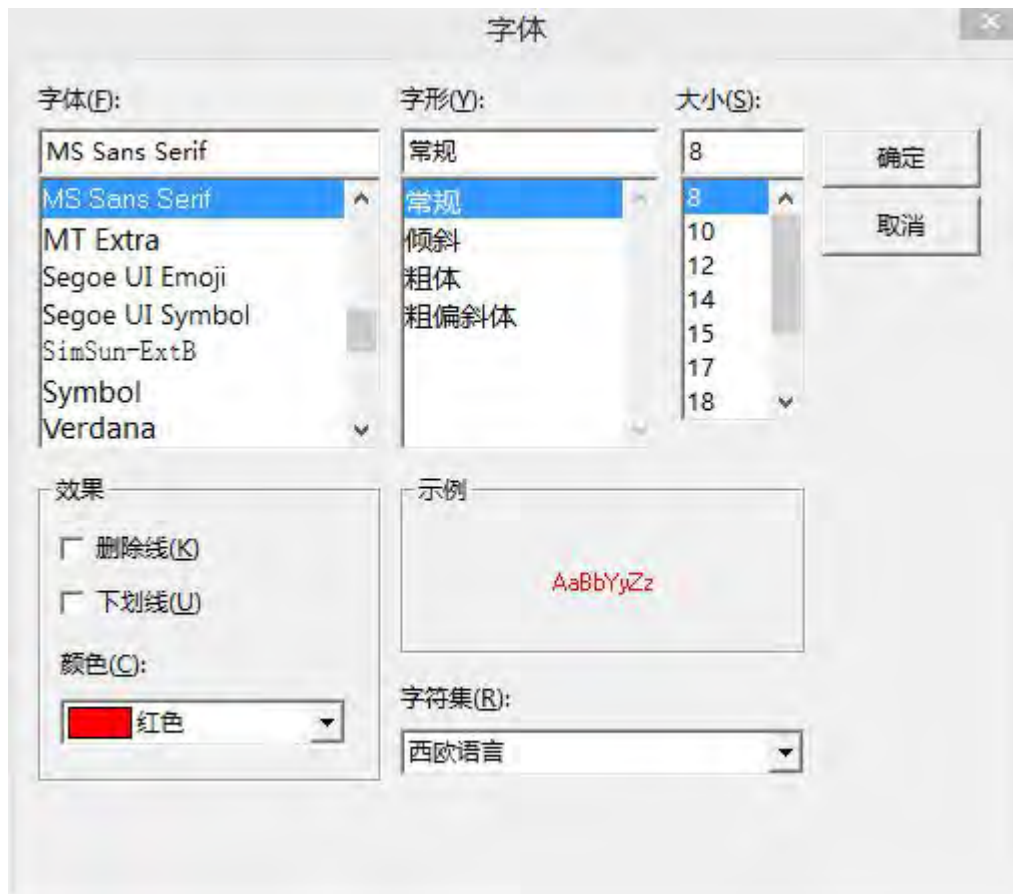

**Component Edit:** The settings dialog box is shown below

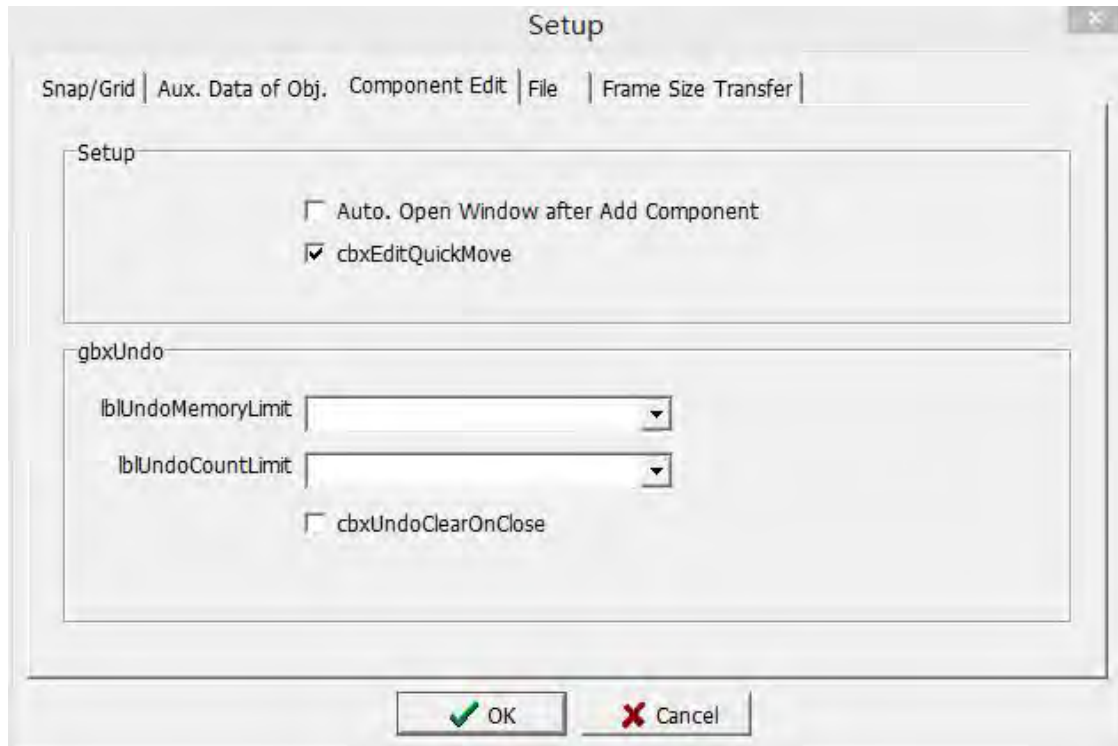

### Set up

After adding a new component, the editing window is automatically opened: Check this option, after adding a new component, the system immediately opens the component properties dialog box. Otherwise, you need to manually double-click the component to open the properties dialog box.

Fast moving components: Check this option, select the component and press the up, down, left, and right buttons of the keyboard or the left mouse button to move the components quickly.

### Recovery settings

Memory limit of recovery function: It is the undo function. Choose to close, not subject to this restriction; choose 8M-512M, that is, to revoke the memory size limit.

Limit the number of recovery function: Choose Close to cancel the unlimited number of times; choose 1 time, irrevocable; choose 2-64 times, you can cancel 1-63 times.

When the editing screen is closed, clear and restore function: Check this option to close the editing screen and clear the editing memory cached by the software at the same time, that is, when the page is opened again, the undo operation cannot be performed.

**File:** The settings dialog box is shown below

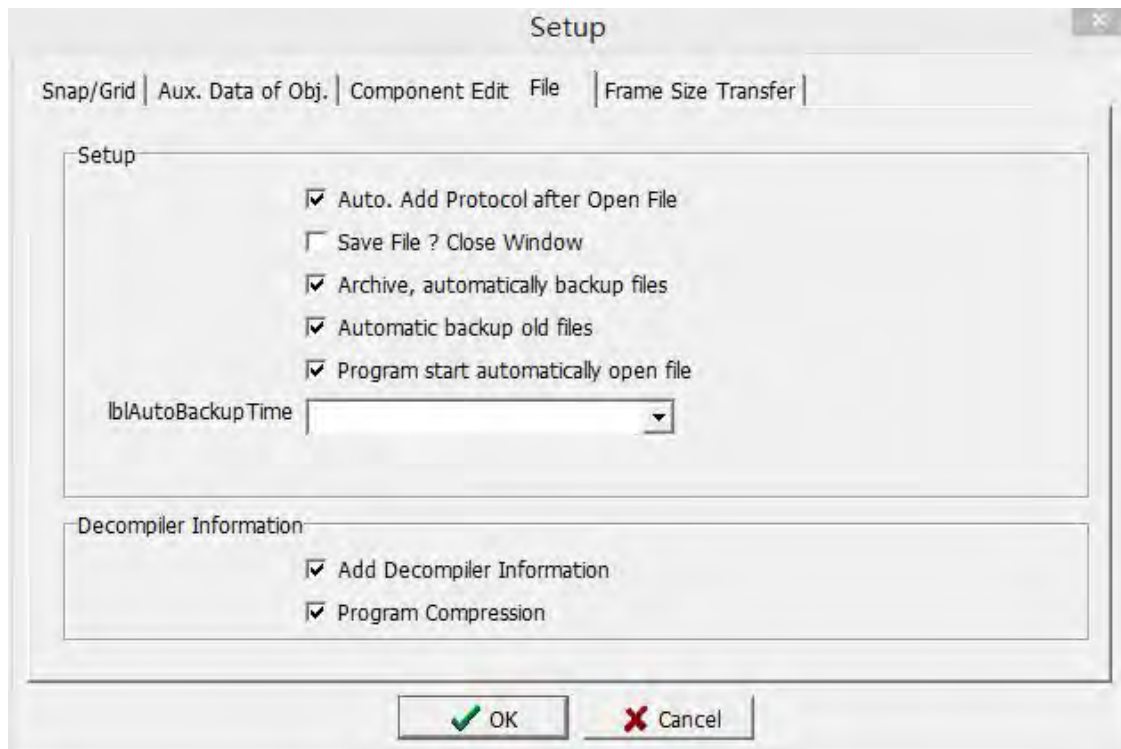

1. After a new project is created, a communication protocol is automatically added: Check this option. After a new project is created, a dialog box for adding a new communication protocol is automatically displayed to facilitate the user to set the communication protocol. Otherwise, it needs to be set manually in the communication management.
2. When closing the screen window, ask if you want to save: check this option, when closing the file, if the file adds new content, it will prompt whether to save.
3. Automatically back up files when saving a project: Check this option to automatically back up files when saving a project. The backup file has the same location as the source file, and the file name is different.
4. Automatic backup when opening the old version project: Check this option to back up the old version file when opening the old version file.
5. Automatically open old files when the program is opened: Check this option to open the file from the last close when the software is newly opened. Otherwise, you need to create a new file or manually open the old file after opening the program.
6. Interval time backup: you can choose to close or 1-10 minutes, preset 3 minutes; after selecting the number of minutes, the project will be backed up according to the selected time interval; the same project can backup up to 32 files, namely backup00-backup31, and then will be overwritten in a loop. Backup path [C:\Users\- 7. Add decompiled information: Check this option to add decompiled information when compiling the project file. That is, the project file read



from the HMI can be modified by programming.

8. Program compression: When the program is downloaded, the project file will be compressed to save download time.

**Frame Size Transfer:** The settings dialog box is shown below

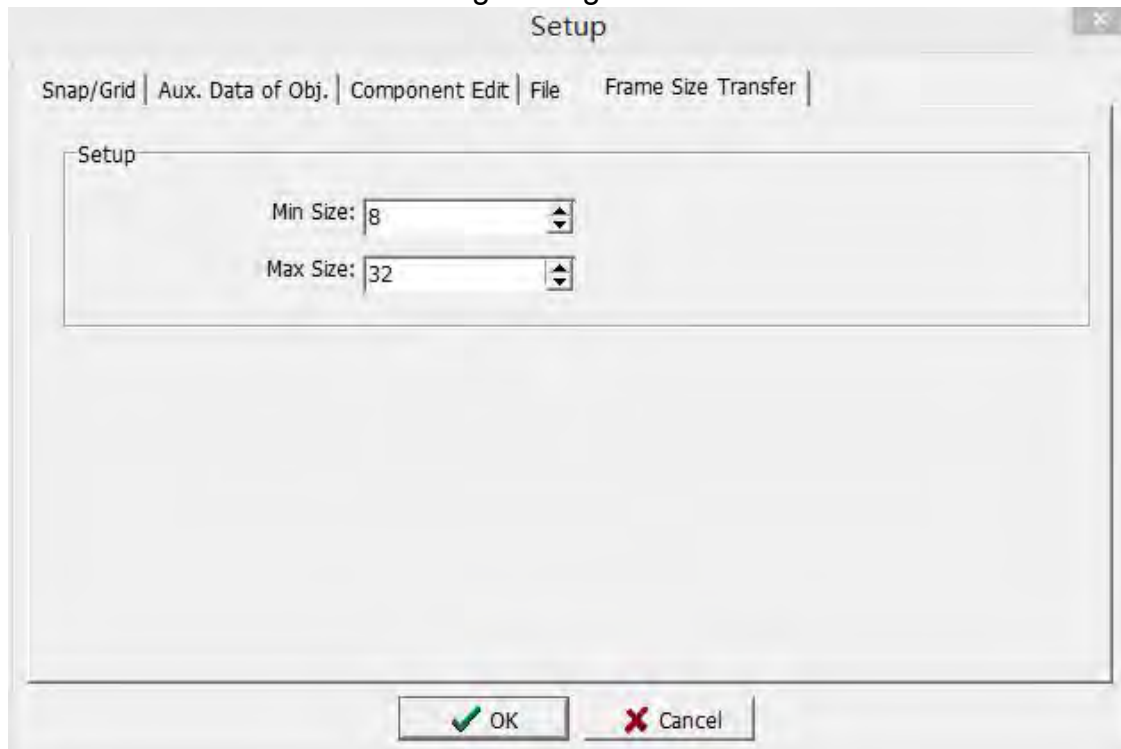

**Mini Size:** After setting the model conversion, the minimum size of the component text size is 8

**Max Size:** After setting the model conversion, the maximum size of the component text size is 32

In the same program, when the model is converted, due to the different screen size, the screen components will be enlarged or reduced proportionally. The font size is set here. During the conversion process, the font size will be modified according to this setting to make the converted screen The layout is more coordinated.

### 2.3.6 Auxiliary data of Object

For the content of this section, please refer to Auxiliary data of Object in Section.

### 2.3.7 Scale

Click [Scale] under the [View] menu, as shown below:

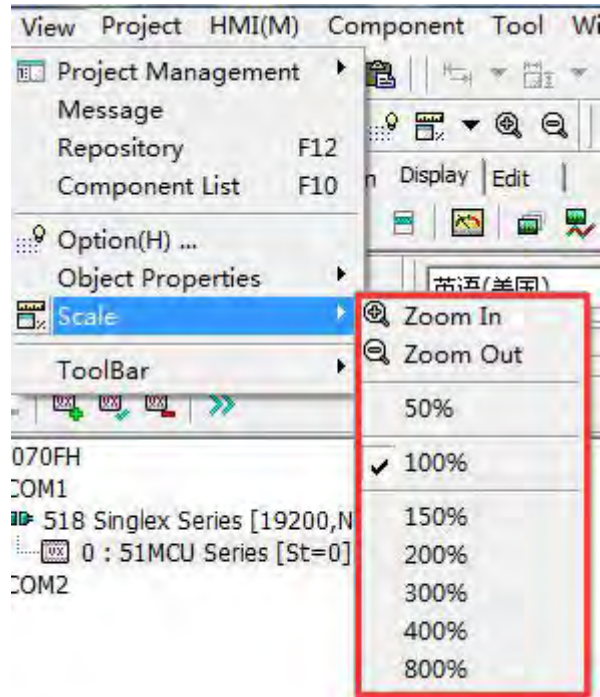

You can choose the size ratio of the picture window according to your preferences. To adjust the size ratio of the screen, you can also use the zoom-in hotkey [I] and zoom-out hotkey [O] set by the system.

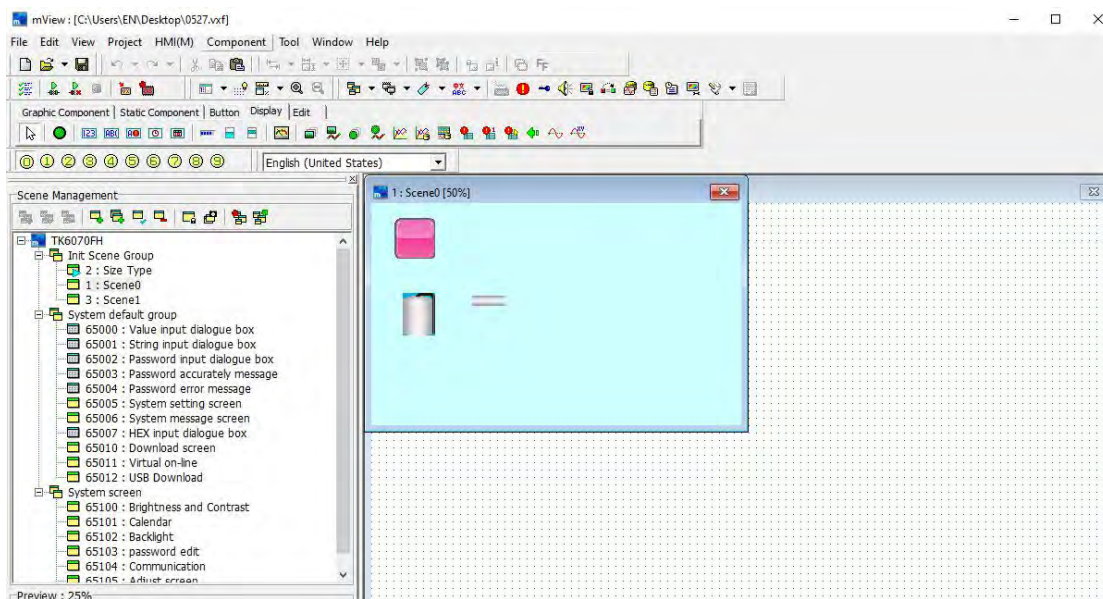

50% magnification display

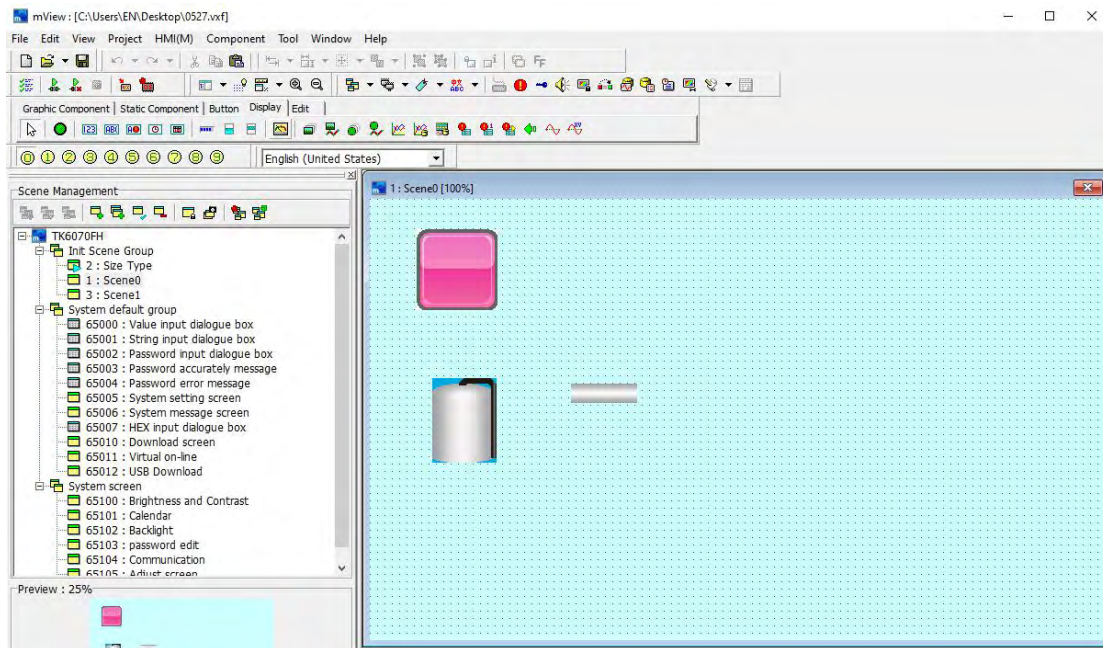

100% magnification display

### 2.3.8 Toolbar

Click [Toolbar] in the [View] menu, you can freely select and display the tools in the shortcut tool, as shown in the following figure:

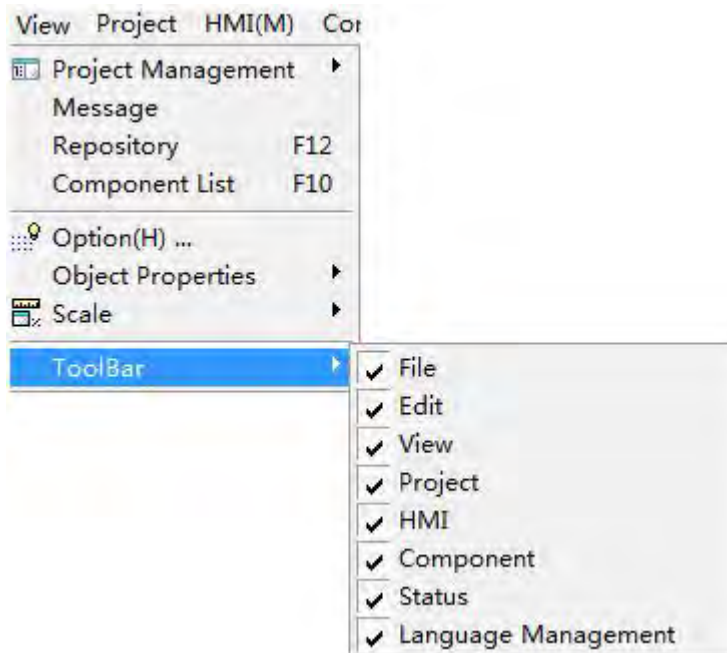

### 2.4 Project

Use the mouse to directly click [Project], or use the keyboard to press [ALT] + [P], the [Project] drop-down menu will appear, as shown in Figure 2-4.1. In order to facilitate users to quickly select, shortcut icons are also provided in



the toolbar, as shown in Figure 2-4.2.

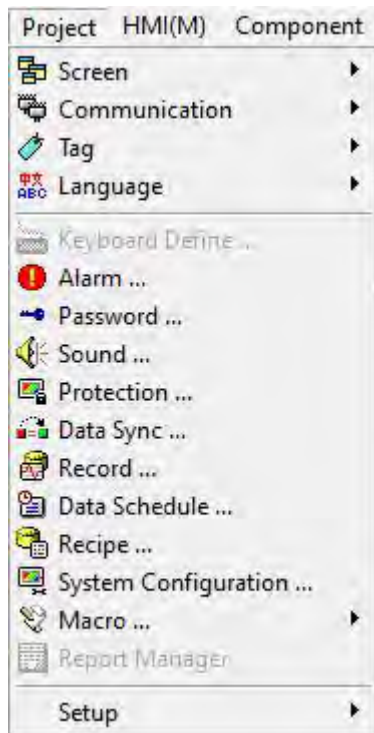

2-4.1

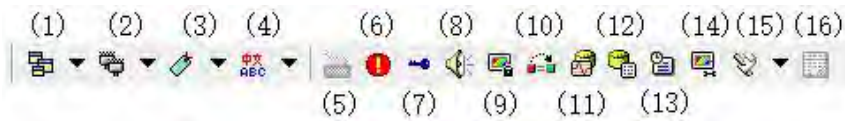

2-4.2

(1)	Screen
(2)	Communication
(3)	Tag
(4)	Language
(5)	Keyboard Define
(6)	Alarm
(7)	Password
(8)	Sound
(9)	Protection
(10)	Data Sync
(11)	Record
(12)	Data Schedule
(13)	Recipe
(14)	System Configuration
(15)	Macro
(16)	Report Manager

### 2.4.1 Screen

Click [Screen] under the [Project] menu, the options shown in the figure below appear, and users can perform operations such as adding, copying, editing, and deleting screens according to the needs of the program. When the mouse focus is on the current screen group of the software program, the options of adding, editing, deleting a group, and opening and closing the group screen will be highlighted and can be used.

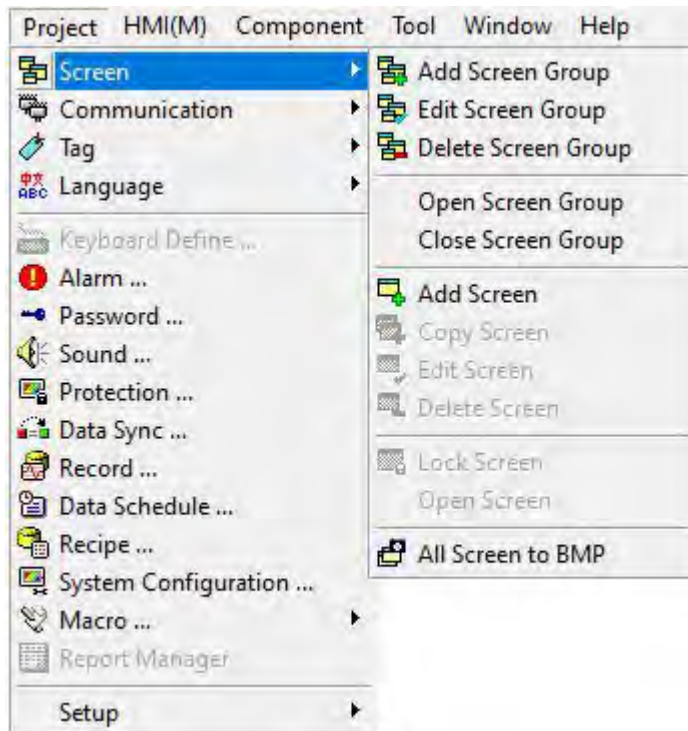

1. Add Screen Group: Click [Add Screen Group], and the setting dialog box shown as below will pop up.



Group Name: Enter the name of this group.

Security: Operation authority 1 ~ operation authority 9, the greater the number, the lower the authority.

Description: Enter the help description of this group, you can leave it blank.

2. Edit Screen Group: Click [Edit Screen Group] to pop up the setting dialog box as shown in the figure below. This function refers to when the group description is not perfect when creating a new group, or when the original group description needs to be modified, use this function to modify the relevant information of the group.

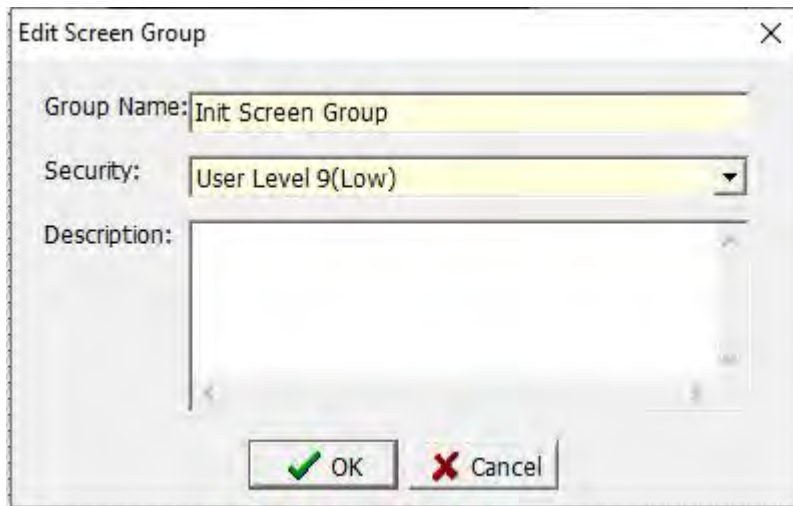

3. Delete Screen Group: Click [Delete Screen Group], and the setting dialog box shown as below will pop up. After clicking the [OK] button, the system will delete all the screen information under the group. After clicking the [Cancel] button, the system does not perform any operation on the group.

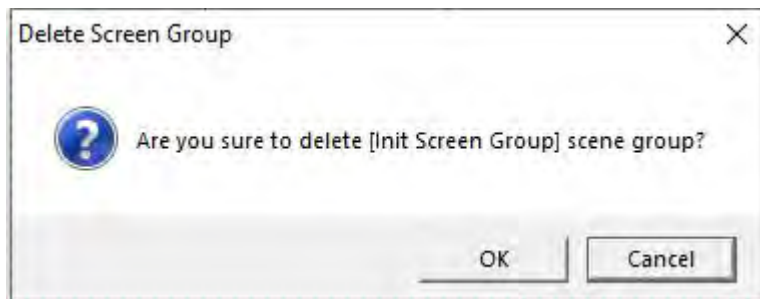

4. Open Screen Group: click this option to open all the screen information in the selected group.
5. Close Screen Group: click this option to close all screen information in the selected group.
6. Add Screen: When you click this option, the New Screen dialog box as shown below will pop up.

## Screen

**Name:** Enter the name of the newly created scene.

**ID:** Enter the number of the newly created screen. The setting range of the number is 1 ~ 32767. The number of each screen cannot be repeated.

**Type:** Click on the drop-down arrow and 4 options appear.

**Normal Screen:** Basic editing operation screen.

**Dialog box:** Select this option to set the screen as the dialog box page.

Dial box specific functions refer to 4.1.1 chapter.

**Boot Screen:** Select this option, the current page is the first screen that appears when you open the touch screen, similar to the startup screen of a computer.

**Initial screen:** The first screen after the touch screen is turned on (the

startup screen has been displayed).

**Security:** Operation authority 1 ~ operation authority 9, the greater the number, the lower the authority. Corresponding authority password setting is set in [Project]-> [Password]

**Set by screen group:** The operation authority is the same as the screen group authority.

**Inherit:** Select this option to make the screen inherit the settings of the selected screen.

The inherited picture is called the parent, and the current inherited picture is the child. When the child inherits the parent, all the components of the parent will be inherited together, but the child cannot change the parent's components, and can only create or modify their own components. If you want to modify the parent components in the child screen, you need to open the parent screen and then modify the components. At this time, all the parent symbols in the child pictures inheriting the parent will be modified at the same time.

**Description:** Enter a help description for the current screen.

#### **Auto Switch**

**Delay Time:** The time interval when switching between scenes.

**Jump to:** After setting the selection screen, when the delay time is reached, it will jump to the set screen.

**Load BG Image:** Click this button to select the desired picture as the screen background.

**Clear BG Image:** Click this button to delete the screen background image.

**Position:** Set the position of the background image.

#### **Macro:**

**Screen OPEN Macro:** Click here to pop up a dialog box to edit the macro program when the screen is opened.

**Screen CLOSE Macro:** Click here to pop up a dialog box to edit the macro program when the screen is closed.

**Screen CYCLE Macro:** Click here to pop up a dialog box to edit the macro program executed in this screen.

**CYCLE Macro Interval :** Set the interval time when executing the macro program of this screen.

The screenshot shows the 'Add Screen' dialog box with the 'Communication' tab active. The 'Quick jump page' section has four rows, each with a gesture icon, a dropdown menu set to 'Undefined', a 'Controlled condition' dropdown, and an 'Apply All Screen' checkbox. The 'Sub Screen' section has six rows: 'Display Addr.', 'Control Addr.', and four 'Sub Screen' entries (1-4) with dropdown menus and associated bit/layer information. At the bottom are 'OK' and 'Cancel' buttons.

**Quick jump page:**

Set the screen page for page change when using the gestures left, right, up, and down.

Controlled condition: refers to the necessary conditions for the establishment of this slide function, as shown in the above figure, when N0 = 100, slide the HMI touch screen to the left, and the screen jumps from the current screen to screen 1.

Apply all screens: Check this option, the slide screen pages of all screens in this group are the same.

**Sub Screen:**



Sub Screen	
Display Addr.:	N0 <span style="color: green;">16</span>
Control Addr.:	N1 <span style="color: green;">16</span>
Sub Screen 1:	2 : Screen0 (BIT 0, Bottom Layer)
Sub Screen 2:	3 : Screen1 (BIT 1)
Sub Screen 3:	4 : Screen2 (BIT 2)
Sub Screen 4:	5 : Screen3 (BIT 3, Top Layer)

**Display Addr:** Set the variable position. Bit0-bit3 of the variable control sub screen 1-sub screen 4 respectively. When the variable is changed, the corresponding sub screen will be displayed, but the sub screen is only in the display state. As shown in the figure above: when N0.0=1, sub screen 1 is displayed; when N0.1=1, sub screen 2 is displayed; and so on...

**Control Addr:** Set the address of the control screen variable, bit0-bit3 of this variable control the variables of sub screen 1 to sub screen 4 respectively; when the [Display Addr] changes, the corresponding sub screen will be displayed, at this time [Control Addr ] You can operate the sub-screen when changing. As shown in the figure above: when N0.0=1, sub-screen 1 is displayed, and when N1.0=1, the variables of sub-screen 1 can be operated. And so on...

**Sub-Screen 1/2/3/4:** Set the sub-screen to be displayed when the variable changes.

For details, please refer to the official website "Sub-screen example"

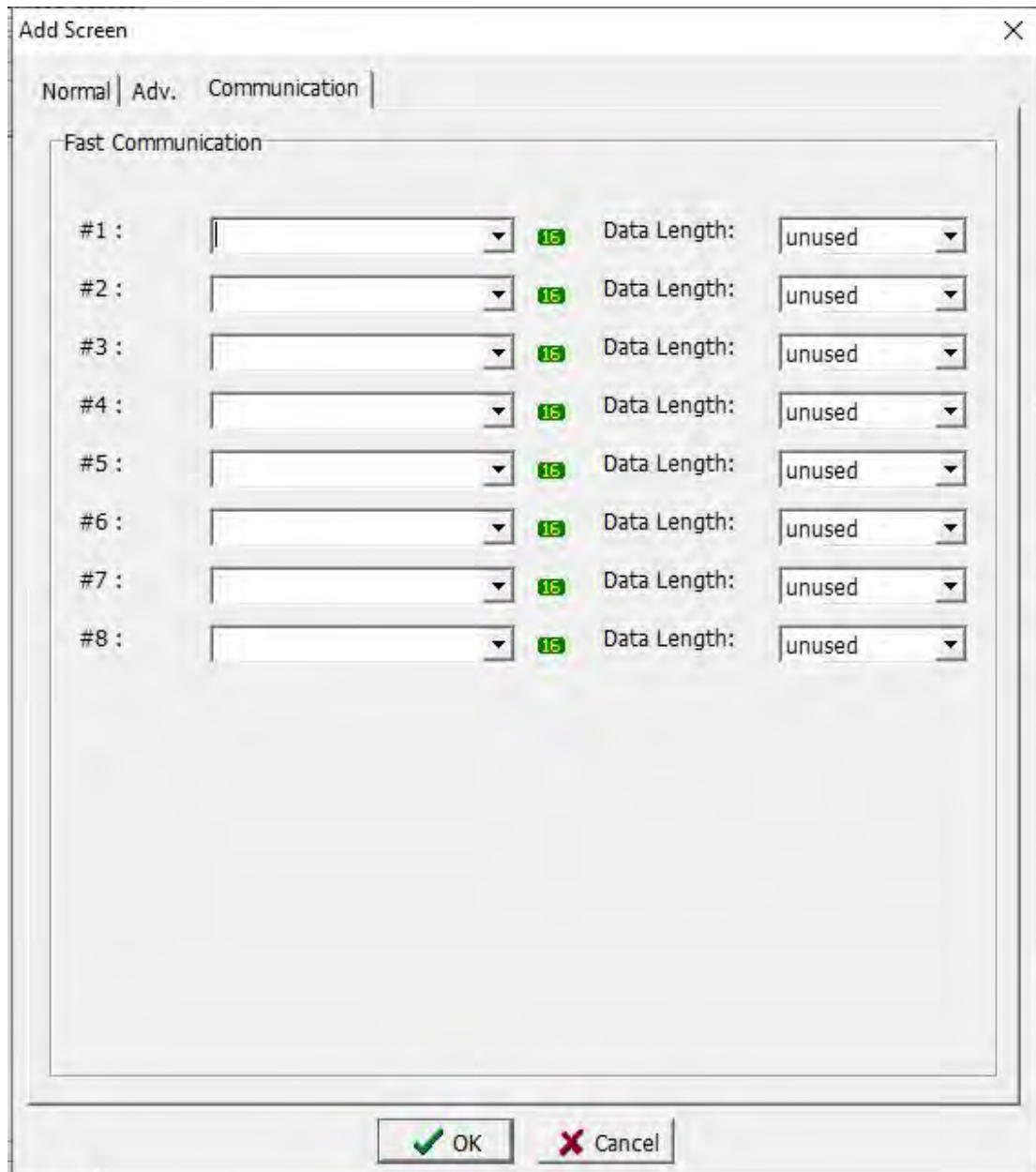

### Fast Communication:

Namely fast reading area, set the fast communication variable of the current screen, so that the set variable can be read quickly.

7. Copy Screen: When you click this option, the current screen will be copied to the PC pasteboard, which is convenient for quickly creating a new screen.

8. Edit Screen: Click this option to edit or modify the attributes of the current screen.

9. Delete Screen: When you click this option, the current screen will be deleted.

The confirmation dialog box for deleting the screen is displayed as shown in the figure below. Click [OK] to delete the screen, and click [Cancel] to do nothing on the current screen.

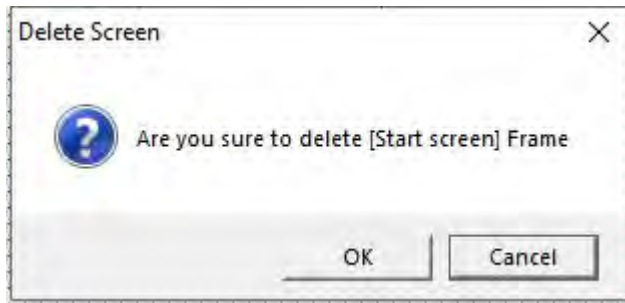

10.Lock Screen: Click this option to fix the current screen components. You cannot add, delete, or modify the components in the screen.

11. Open Screen: click this option, the screen jumps to the screen where the focus is in the screen management.

Example: The current screen is screen 1, click screen 2 in screen management, and then click [open screen], then the current screen jumps to screen 2.

12. All Screen to BMP: Click this option to output all pictures in the current project as pictures and save them in the path specified by the user.

## 2.4.2 Communication

Click [Communication] under the [Project] menu, and the options shown in the figure below appear. The user can add, edit, and delete communication protocols and controllers according to the needs of the program.

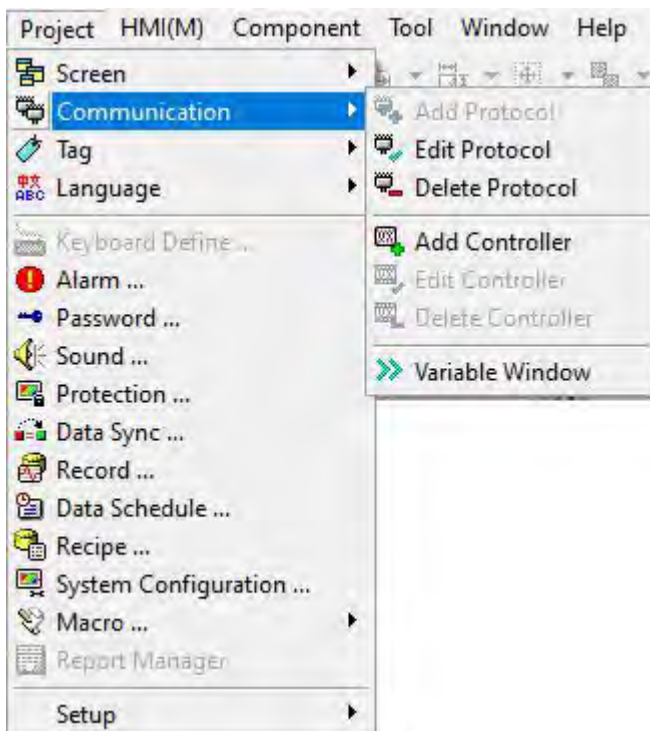

1. Add Protocol: After selecting a communication port that has not been configured with a communication protocol, click [Communication], and then the option [Add Protocol] will be highlighted. Click this option, the following dialog

box will pop up:

The screenshot shows the 'Add Protocol' dialog box with the following settings:

- Protocol:** CoolMay PLC(3U/3G)/FX3U
- Controller:**

Company	Model	Des...
CoolMay	CoolMay 3U Series	PLC
- Port:** Auto Detect(RS232/RS422/RS485)
- Baud Rate:** 9600
- Data Bit:** 7Bits
- Parity:** Even
- Stop Bit:** 1Bit
- Delay:** 0ms
- TimeOut:** 1sec
- Multi-Station Smart Link
- Retry Count:** Timeout, Repeat

**Protocol:** Use the drop-down options to select the communication protocol to be used.

**Controller:** Display the manufacturer and model selected by the communication protocol.

**Port:** There are four options for selection, automatic identification, RS232, RS422, RS485.

**Baud Rate:** from 150 ~ 115200 rate, available for selection.

**Parity:** [none], [odd parity], [even parity], [mark], [space].

**Data Bit:** [5], [6], [7], [8].

**Stop Bit:** [1 digit], [2 digits].

**Delay:** from no delay, delay 10ms to delay 5000ms, available for selection.

**Timeout:** [0.1 sec], [0.2 sec], [0.5 sec], [1 sec], [1.5 sec], [2 sec], [3 sec], [5 sec], [10 sec] total 9 Options.

**Retry Count:** Set the number of retransmissions when the communication is unsuccessful.

**Multi-Station Smart Link:** see Appendix 5 for details.

**OK / Cancel:** After setting, press [OK] to save the completed settings, press [Cancel] to exit the dialog box without setting the communication protocol.

2. **Edit Protocol:** After setting up a new communication protocol, if there is a setting error, you can use this function to modify it.

3. **Delete Protocol:** delete the communication protocol that has been newly created.

4. Add Controller: After the communication protocol is added, the controller to which the protocol belongs needs to be set. Click the [Add Controller] option, a dialog box as shown below will pop up:

Add Controller ✕

Controller

ID:

Station:

Controller:

Company	Model	Description
CoolMay	CoolMay 3U Series	PLC

Description:

ID: ID number of the controller.

Station: the station number of the controller, that is, the ID number of the PLC,

Controller: Display the selected manufacturer, model, description and other information.

Description: Enter a description or help for this controller.

OK / Cancel: After setting, press [OK] to save the completed settings.

Press [Cancel] to exit the dialog box without setting the controller.

5. Edit controller: Select an existing controller and click this option to modify its settings.

6. Delete controller: Select an existing controller and click this option to delete it.

7. Variable Window: Click this option to pop up the dialog box as shown in the figure below,



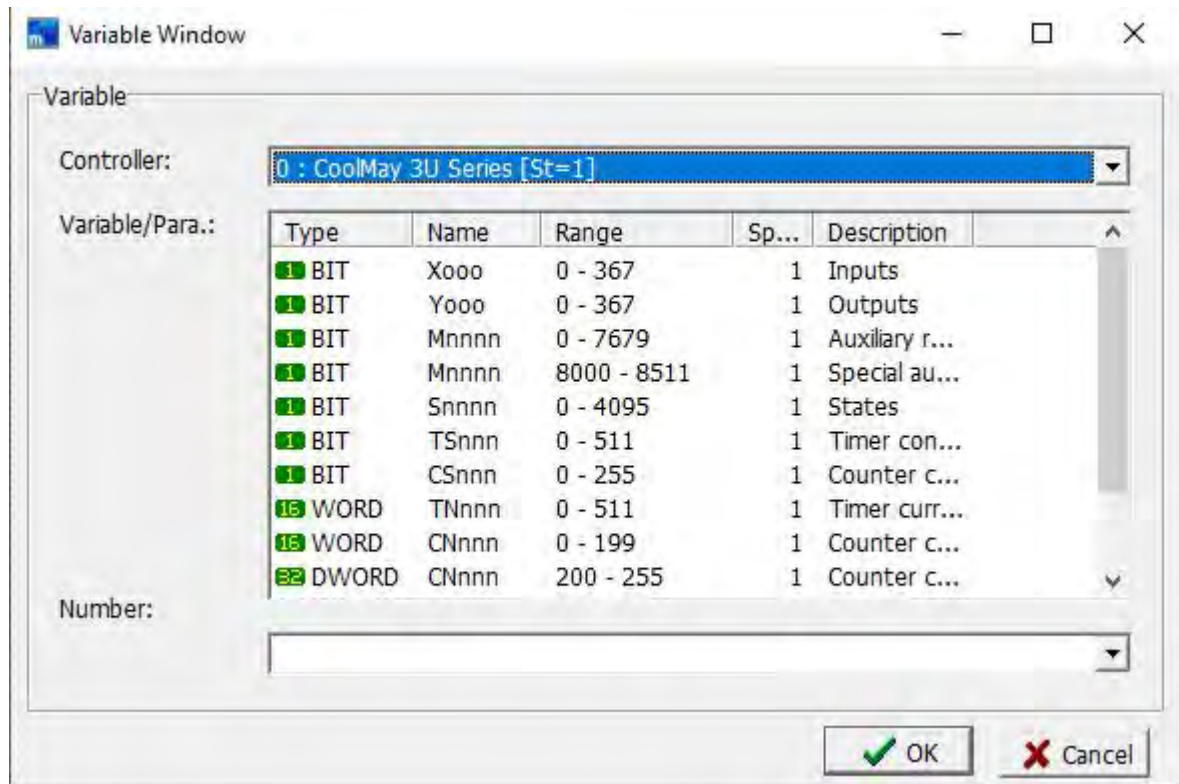

Controller: Provide HMI internal variables or controller variables set in the communication protocol for selection.

Variable/Para.: Displays the specific information of the variables included in the selected controller.

Number: Open this window in the component properties window, you can directly enter the variables of the system or controller.

### 2.4.3 Tag

There are many types of controllers that communicate with the human-machine interface. The communication protocol and memory numbers of different manufacturers are not the same. In order to facilitate the function of memorizing contacts and memory numbers, you can use tag management to increase readability. For example, when adding a label, we want to replace the X1 contact with the name "for testing". After the addition is complete, enter "for testing" in the write or read position only when the component needs to use X1 "Or click the drop-down option to select" for testing ", the system will treat "for testing "as X1. After setting to tag management, users can replace the names of contacts and memory on the communication protocol specifications with names that are easy to remember.

Click [Tag] under the [Project] menu, and the options shown in the figure below appear. The user can perform operations such as adding, editing, and deleting communication protocols and controllers as required by the program.



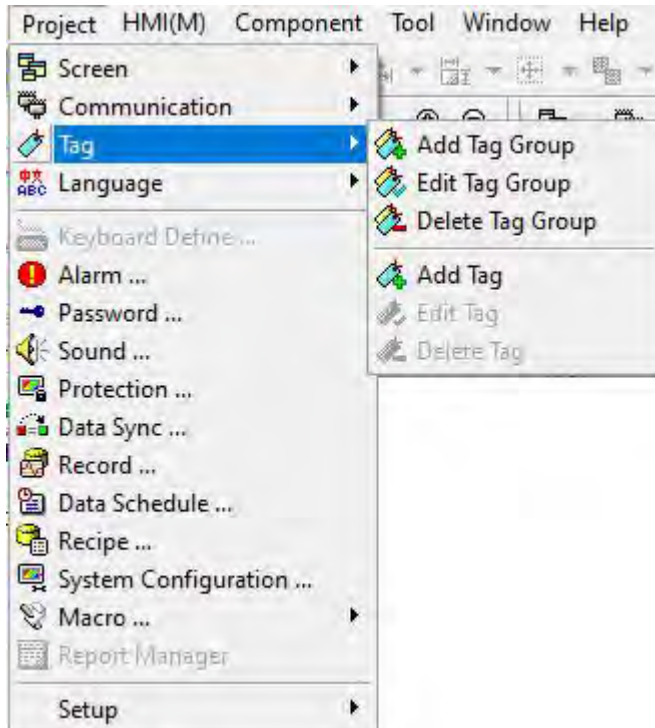

1. Add Tag Group: classify tags for easy management and editing.

Click [Add Tag Group], a dialog box as shown below will pop up:

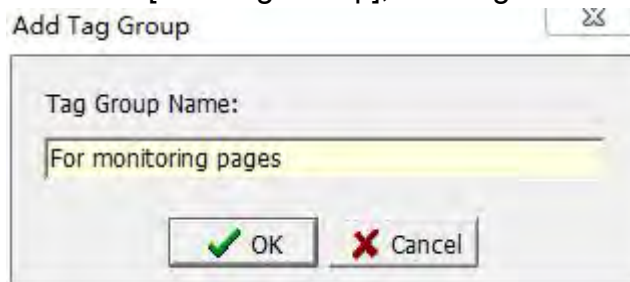

Enter the name of the newly added tag in the tag group name and click the [OK] button. The newly added tags are newly added to the tag management, as shown in the following figure:

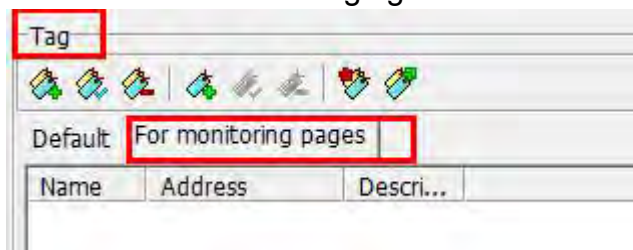

2. Edit Tag Group: modify the name of the currently selected tag.

3. Delete Tag Group: modify the currently selected tag.

Click this option to pop up the dialog box as shown in the figure below. Click the [OK] button to delete the selected tag group. Click the [Cancel] button to keep the selected tag group.



#### 4. Add Tag: add a new tag.

Click this option to pop up the dialog box shown below:

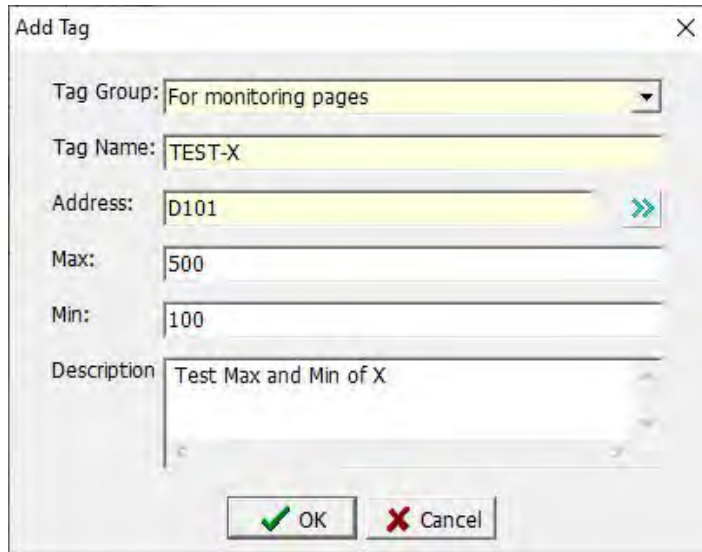

**Tag Group:** The current tag group is written by default and can be selected using the drop-down list.

**Tag Name:** Enter the identification name corresponding to this location, you can replace the location.

**Address:** Enter the correct contact or memory location of the controller to be used, and the register address D101 of Mitsubishi PLC FX3U is used in the above figure.

**Max:** Enter the maximum value of this contact or memory, you can not enter it.

**Min:** Enter the minimum value of this contact or memory, you can not enter it.

**Description:** Enter the description of this label, you can not enter it.

**OK / Cancel:** After setting, press [OK] to save the completed settings, press [Cancel] to not proceed Set the label and exit the dialog box.

#### 5. Edit Tag: modify the content of the existing tag and other operations.

#### 6. Delete Tag: delete the existing tag.

### 2.4.4 Language

Click [Language] under the [Project] menu, and the options shown in the figure below appear. The user can add, edit, delete language selection, and

set the initial language translation according to the needs of the program.

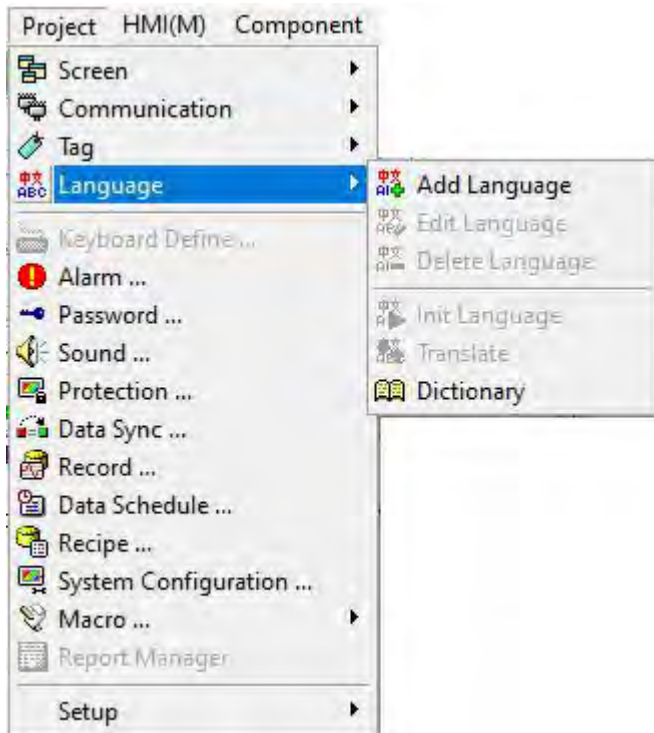

1. Add Language: add a new language.

Click this option to pop up the dialog box shown below:

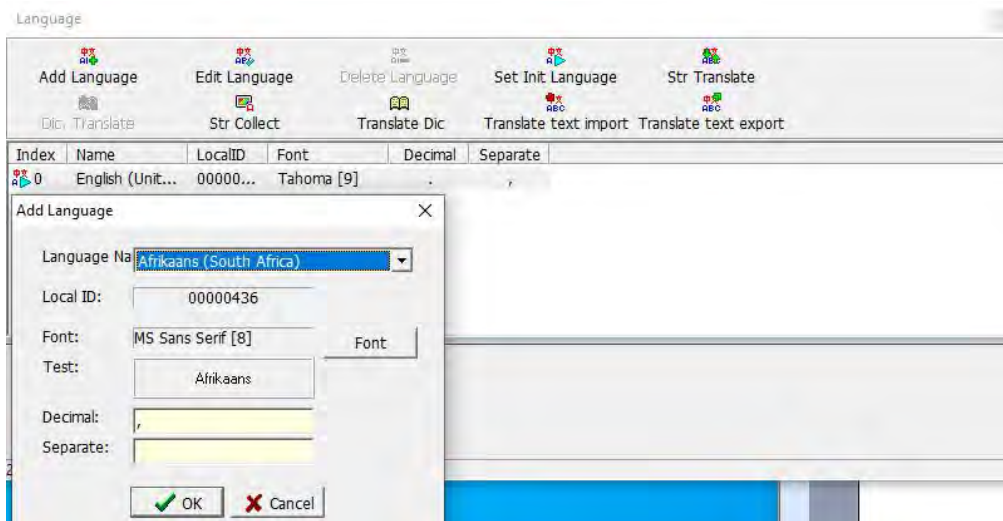

**Name:** Click the drop-down list to select the language to be created.

**Local ID:** The region code of the region where the selected language is located. This item is added by default.

**Font:** displays the selected preset default font.

**Font:** Click this button to pop up the font selection dialog box, as shown in the following figure, you can set the default font, font style, size, effect, underline and color of the new language.

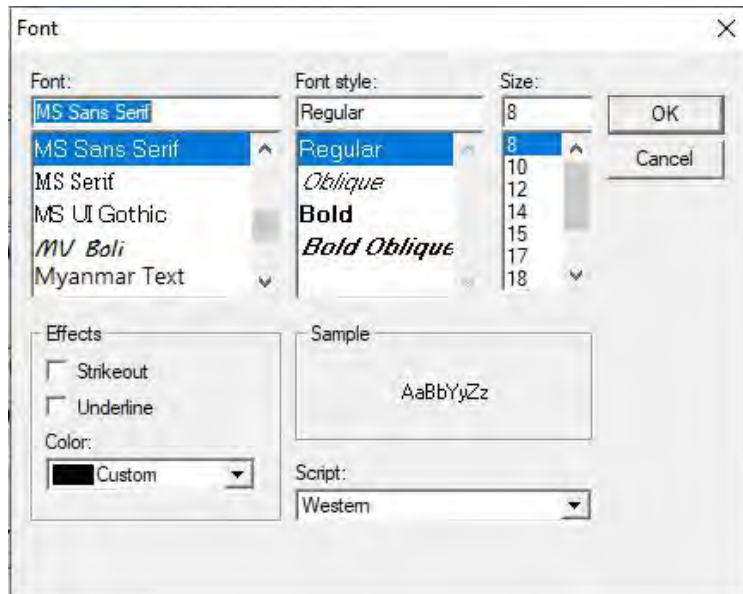

Test: display the template of the selected font.

Decimal: Set which symbol to display when displaying the decimal symbol.

Separate: Set which symbol to use when displaying the separator.

2. Edit language: Click this option to set the font, font style, size, effect, underline and color of the existing language.

3. Delete language: Click this option to delete the existing language.

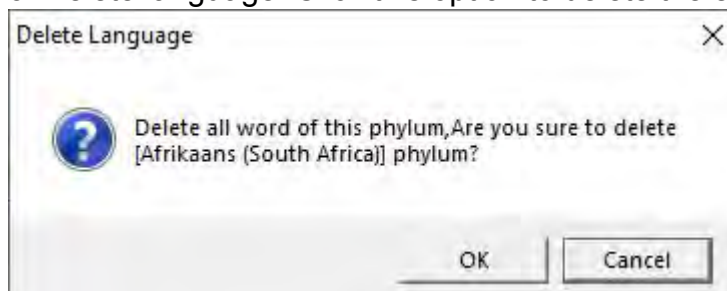

4. Initial language: click this option under multiple languages to set the initial language.

5. Translate: Click this option to convert the language on the screen to the selected language.

6. Dictionary: Set the corresponding language translation by yourself.

For a detailed introduction and application examples of language management, please refer to Chapter 5 Language Management.

### 2.4.5 Keyboard Define

This model does not have this function temporarily.

### 2.4.6 Alarm

After clicking [Alarm] under the [Project] menu, the setting dialog box

shown below will pop up to set the alarm information. For detailed introduction and cases of specific alarm management, please refer to Chapter 6 Alarm Management.

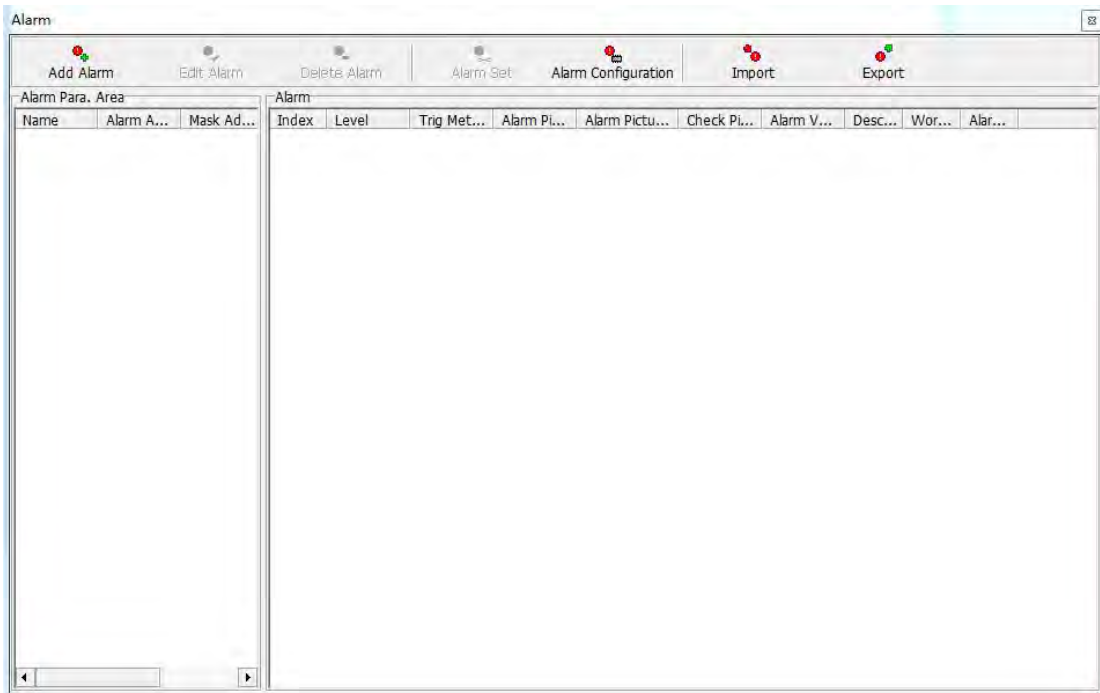

**Add Alarm:** Add a new alarm information area.

**Name:** Enter the name set for the newly added alarm zone.

**Address:** The position of the input variable can be selected by the drop-down arrow symbol or directly input the variable position. As shown in the above figure, the icon button **15** behind the input box indicates that



this position must be WORD. Click this button to pop up the variable window shown below. The type of variable. At the same time, you can also enter or select the desired variable in the number edit box in the figure below.

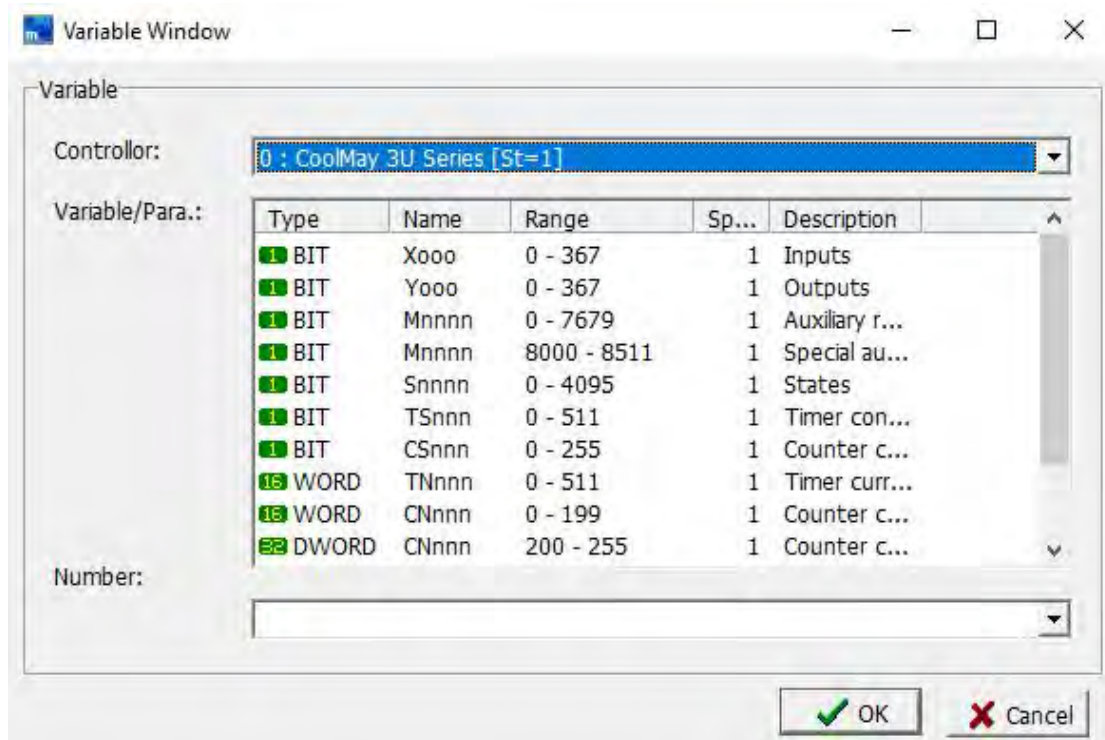

**Mask:** When the alarm is triggered, this function can be used to mask the alarm, that is, the alarm information and sound are not displayed. The method of selecting the mask address is the same as the method of selecting the address of the alarm area.

**Update:** You can choose how often to update. If you select 3 seconds, it means that you will check whether the alarm is triggered every 3 seconds.

**Delay:** choose whether to wait for the controller to start to create data and then start the alarm time.

**Group:** You can check the group to which this alarm will be classified. Double-click the left mouse button in the group to edit the group name.

**Description:** Enter the help description for this alarm.

## 2.4.7 Password

After clicking [Password] under the [Project] menu, the setting dialog box shown below will pop up to set the password for setting the user authority. For a detailed introduction and case of specific password management, please refer to Chapter 7 Password Management.

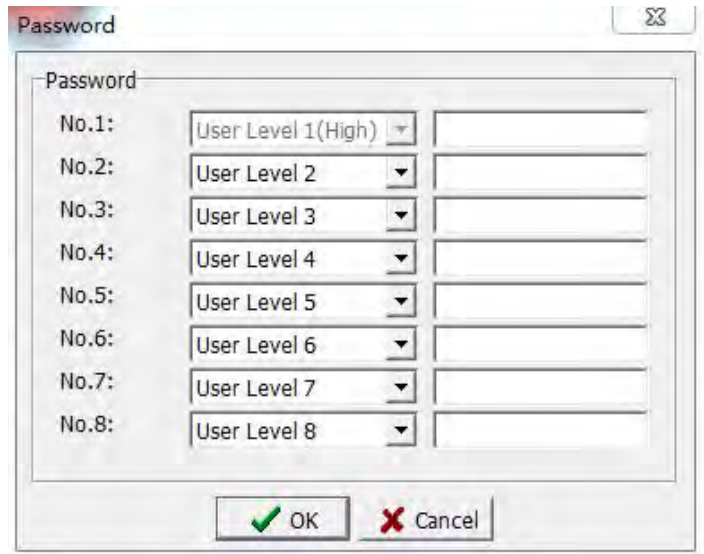

## 2.4.8 Sound

After clicking [Sound] under the [Project] menu, a dialog box for setting audio as shown in the figure below will pop up to set the audio that the user needs to use. For a detailed introduction and case of specific audio management, please refer to Chapter 8 Sound Management.

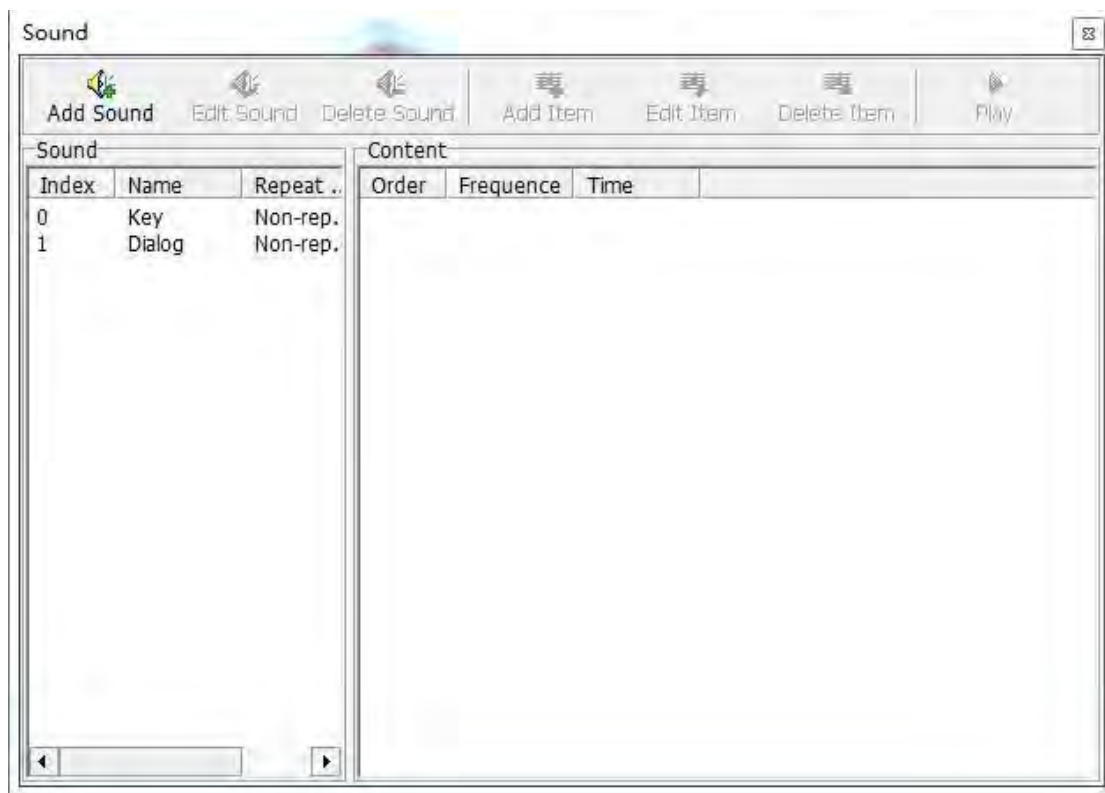

## 2.4.9 Protection

After clicking [Protection] under the [Project] menu, a dialog box as shown below will pop up to set the upload / download password of the HMI program. To achieve the function of data protection.

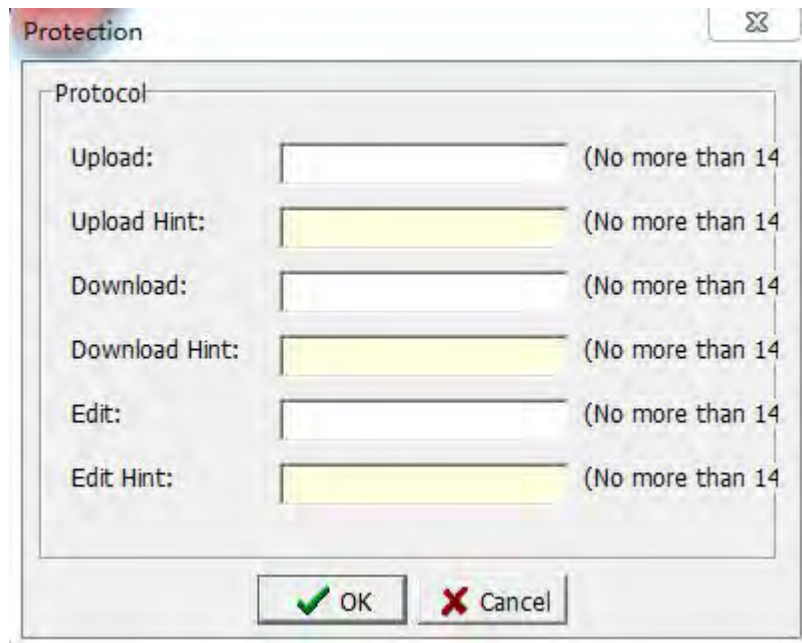

Password protection for project uploading, downloading, uploading and editing, and setting of passwords and password prompts. After setting the [Download Password], use the [Save Project to File] function under the [HMI] menu to save the project as a vho file. If you want to use this vho file to download to HMI later, select [Tool]-> [Download HMI program ...], a dialog box as shown in the figure below will pop up to select the vho file.

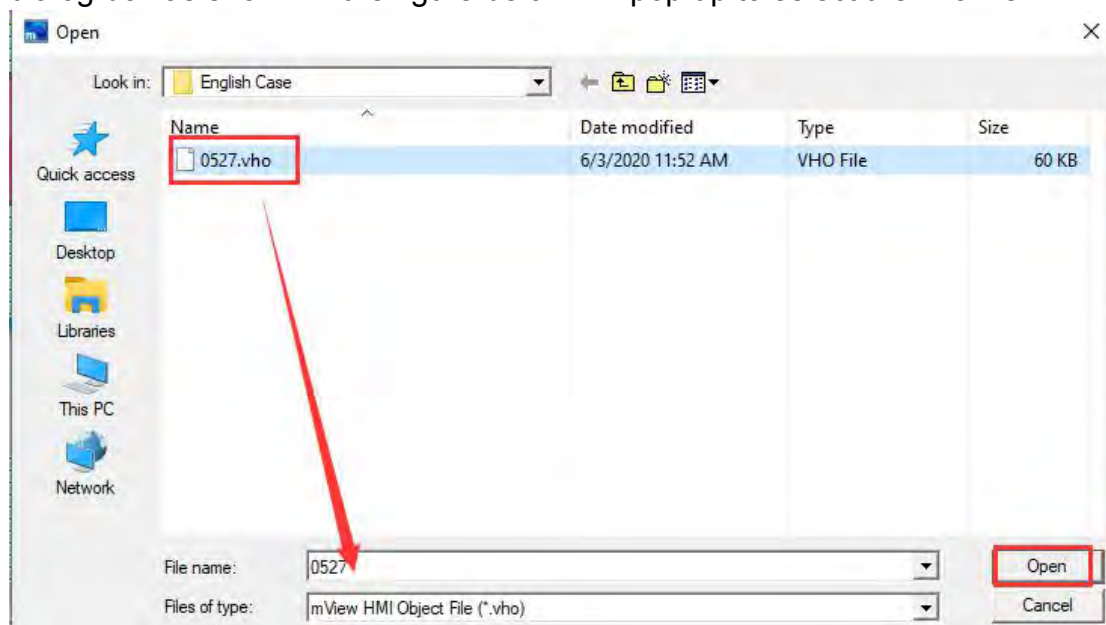

After confirming the vho file selection, click the [Open] button, and the download password input box will pop up as shown in the figure below. After

entering the password correctly, click the [OK] button to download the program to the HMI.



### 2.4.10 Data sync

After clicking [Data Sync] under the [Project] menu, a dialog box as shown below will pop up. For a detailed introduction and case of data synchronization management, please refer to Chapter 9 Data Synchronization Management.



### 2.4.11 Record

After clicking [Record] under the [Project] menu, the following dialog box will pop up.

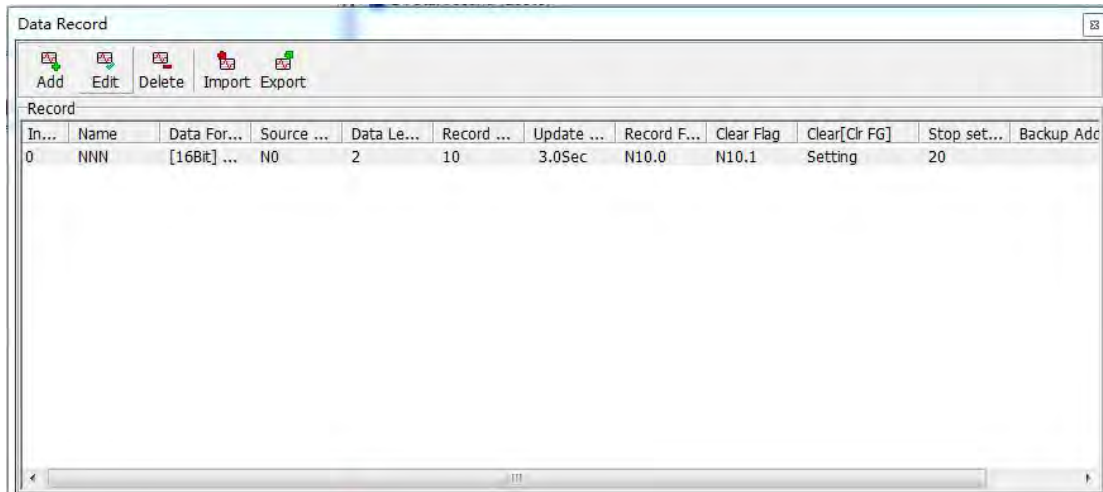

**Add:** Click this button to pop up the dialog box for defining a new data record as shown in the figure below.

**Edit:** Click this button to re-edit the selected existing data record.

**Delete:** Click this button to delete the selected existing data record.

**Import:** Click this button to import the data record of the vdr file stored in the computer into the HMI project.

**Export:** Click this button to export the data records in the HMI project to a computer and store them in a vdr file.

The Add data record definition dialog box is shown below:

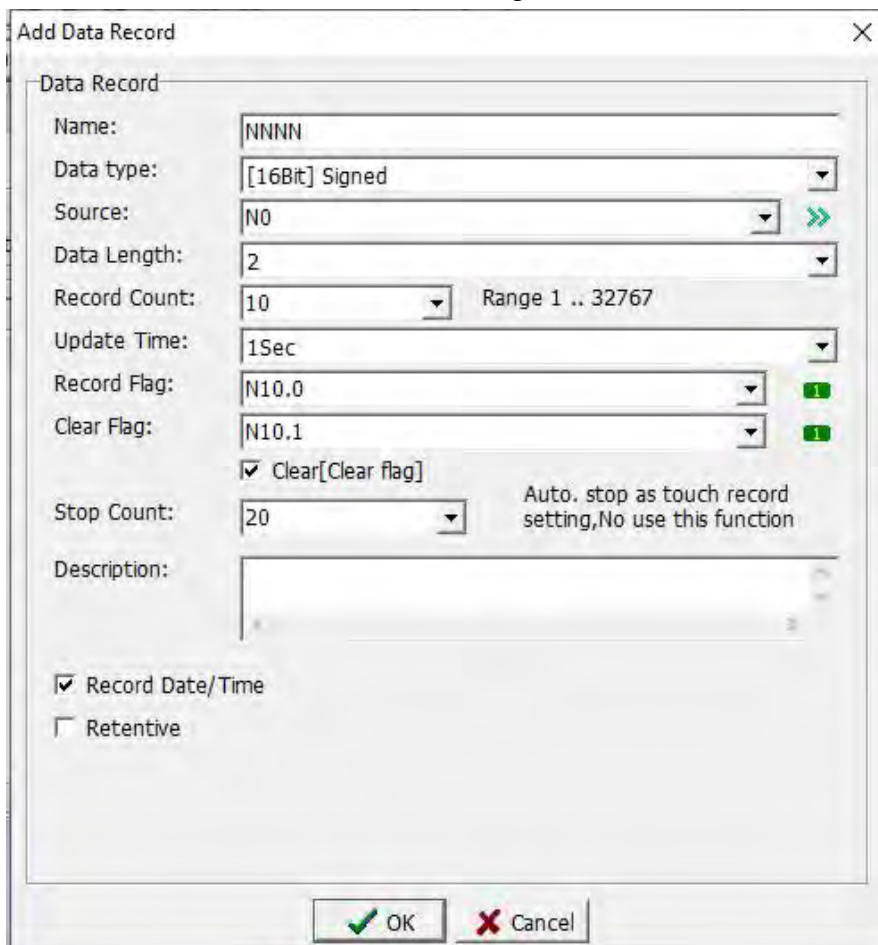



Name: Enter the name of the data record.

Data Format: Select the type of data. There are five types of contacts, 16-bit signed / unsigned, 32-bit signed / unsigned.

Source: Set the location of the data source.

Data Length: set the length of the data, the range is 1 ~ 16. For example, if it is set to 4, and the source address of the data is set to D0, it means that the data is read from D0 ~ D3, which has 4 register addresses.

Record Count: set the total number of records of the data, the range is 1 ~ 32767.

Update Time: set the interval time record data. That is how often to record.

Record Flag: Set a variable, and use this variable to control start recording and stop recording.

Clear Flag: Set a variable to control the clearing of previously recorded data. For example, select M0 here, when M0 is turned on, clear the previously recorded data.

Clear [clear flag]: Check this option to clear the flag while disconnecting the clear flag. That is, when M0 is turned on, after clearing the previously recorded data, M0 is turned off.

Stop Count: Set to stop recording when recording to the set quantity.

When set to 0, this function is not used, that is, the data is always recorded.

Description: Provide supplementary explanation for this record, you can leave it blank.

Record Date/Time: Check this option to record the time when recording data when recording data.

Retentive: Check this option, the data will be saved when the HMI is powered on again.

#### 2.4.11.1 Case of Record use

Click the software menu-> [Project]-> [Record...], Data record management dialog box as shown below pops up.

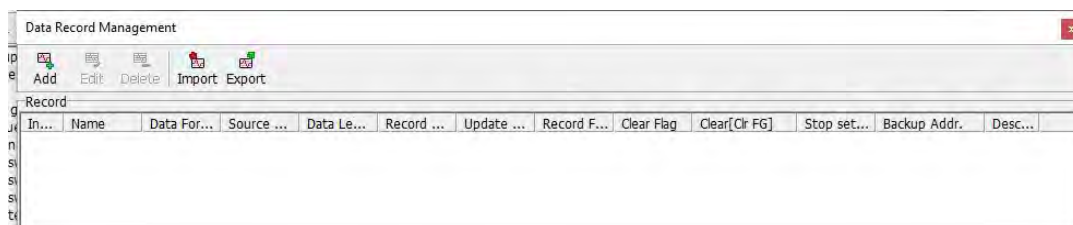

Click the [Add] icon, and in the pop-up New Data Record Definition dialog box, set each record as shown below:

Add Data Record

Data Record

Name: NNNN

Data type: [16Bit] Signed

Source: N0

Data Length: 1

Record Count: 10 Range 1 .. 32767

Update Time: 1Sec

Record Flag: N10.0

Clear Flag: N10.1

Clear[Clear flag]

Stop Count: 0 Auto. stop as touch record setting, No use this function

Description:

Record Date/Time

Retentive

OK Cancel

After the setting is completed, click the [OK] button, and the data record management display is as shown below.

Data Record Management

Add Edit Delete Import Export

In...	Name	Data For...	Source ...	Data Le...	Record ...	Update ...	Record F...	Clear Flag	Clear[Cr FG]	Stop set...	Backup Addr.	Desc...
0	NNNN	[16Bit] ...	N0	2	10	1.0Sec	N10.0	N10.1	Setting	0		

After the data is added, the data record can be used. When using [Element]-> [Display Element]-> [Historical Trend Graph], the [Historical Trend Graph] property screen as shown below.

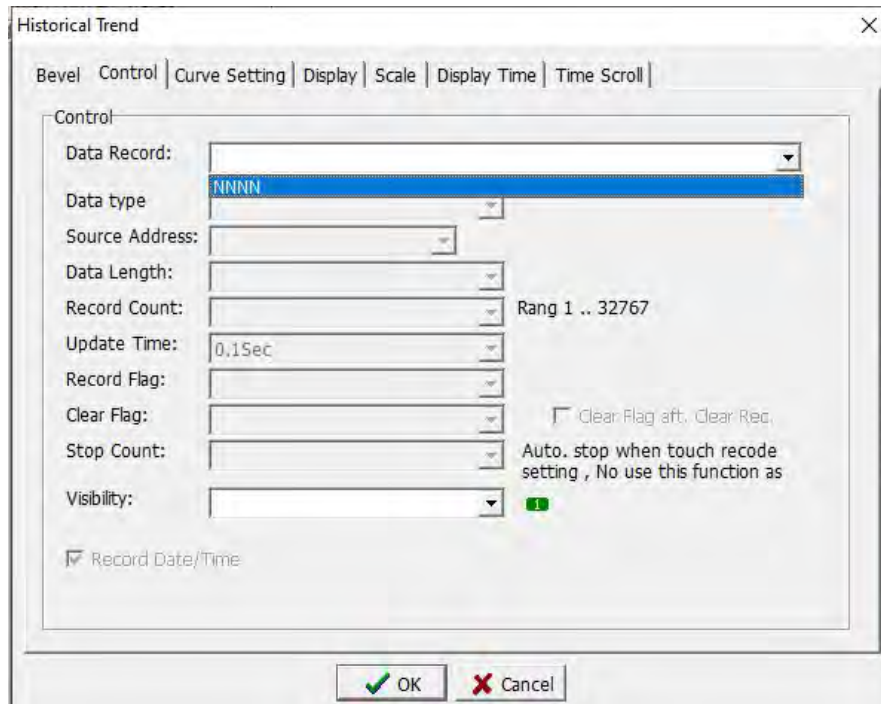

In the data record drop-down list, select the data to be recorded. In this example, select the NNNN data. After selection, the following figure is shown.

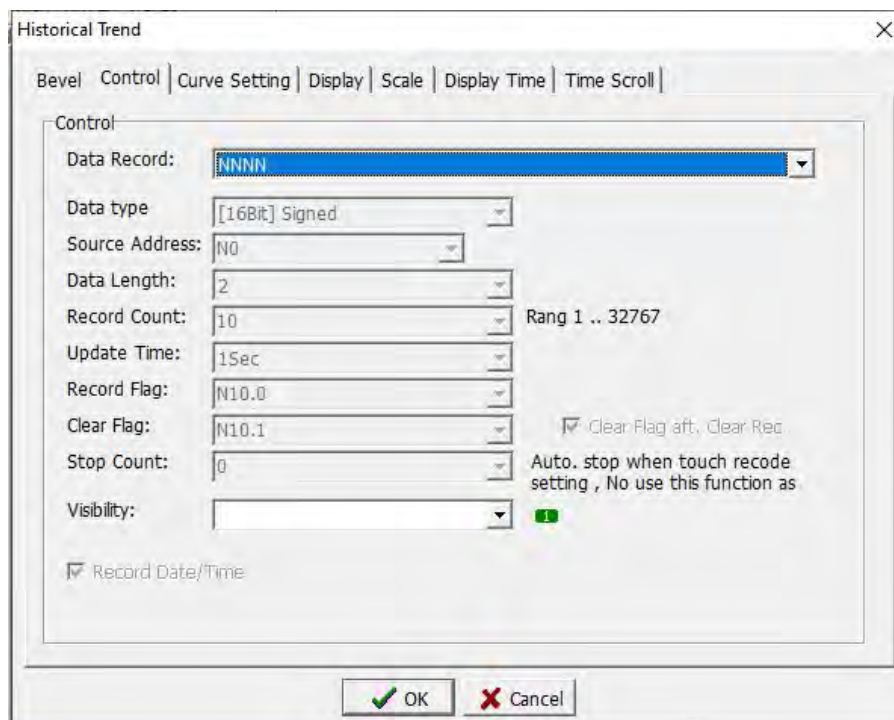

As set in this example, when the recording flag condition is reached, that is, when  $N10.0 = 1$ , the data of N0 and N1 will be displayed in a curve, and the record is shown in the figure below

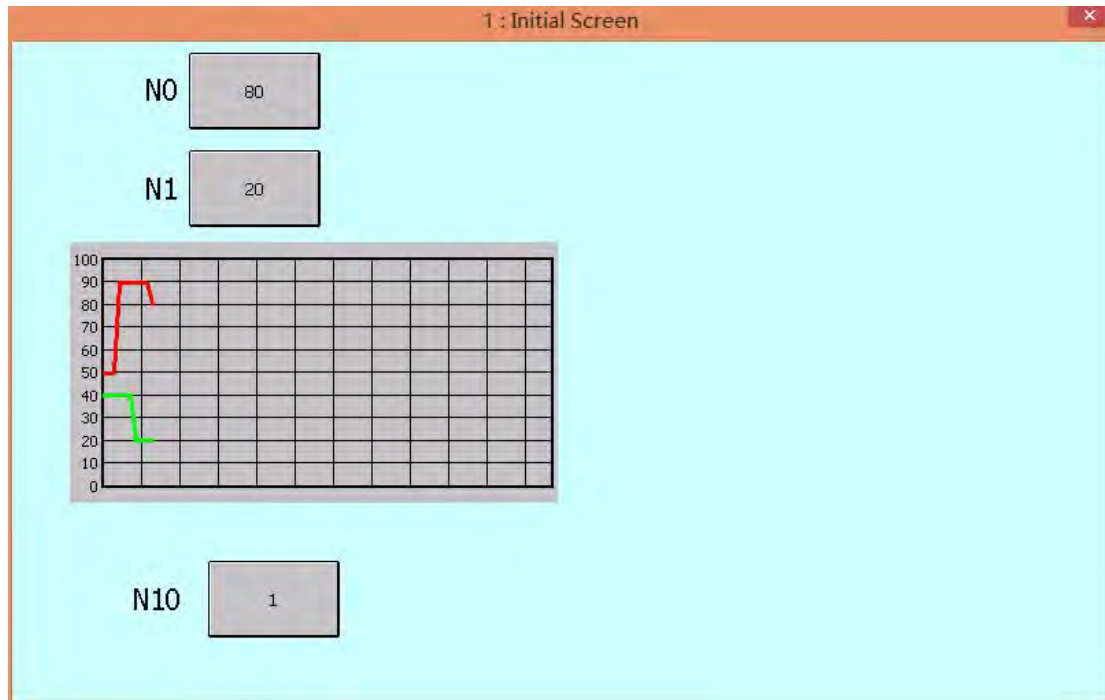

When you need to delete the curve, set the value of the clear flag to 0, that is,  $N10.1 = 0$ . In this example, set  $N10.0$  to 0, as shown in the following figure.

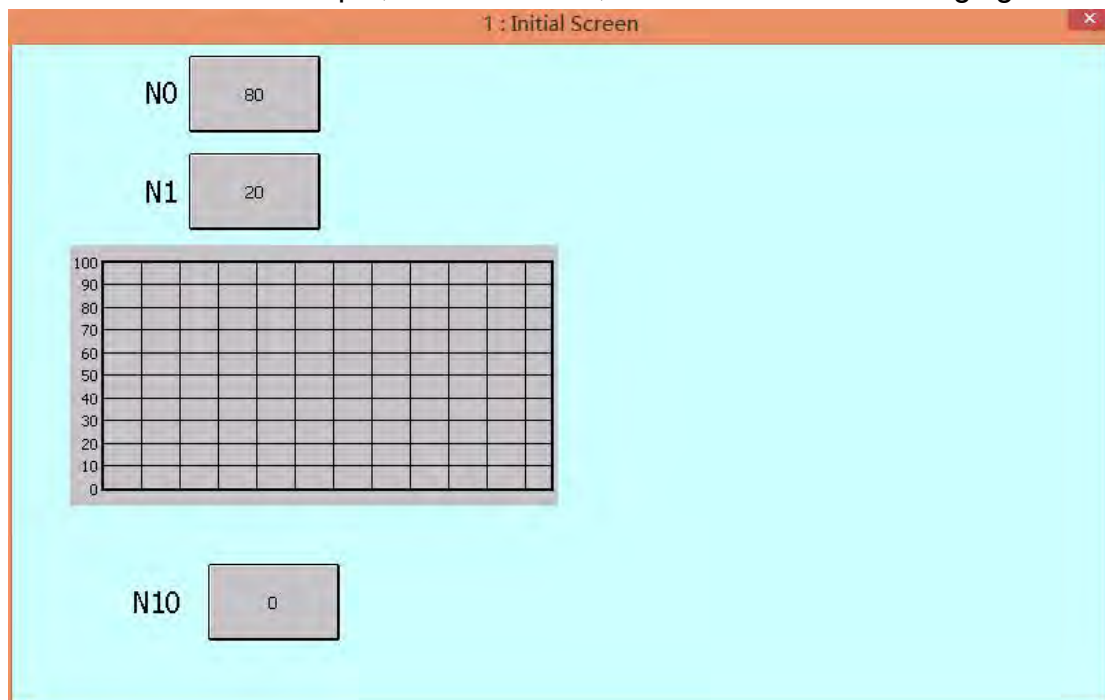

### 2.4.12 Data schedule

After clicking [Data Schedule] under the [Project] menu, the following dialog box will pop up. It can be used to implement the scheduling requirements for a fixed time or a specific time to perform control.

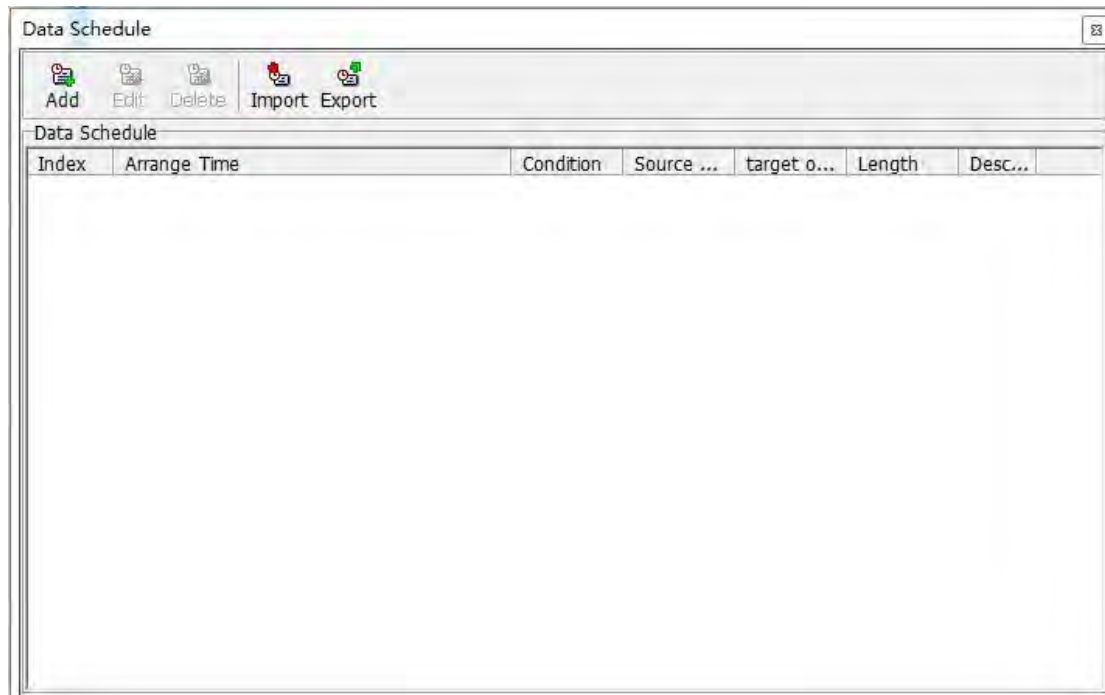

**Add:** Click this button to pop up the new data schedule definition dialog box as shown in the figure below:



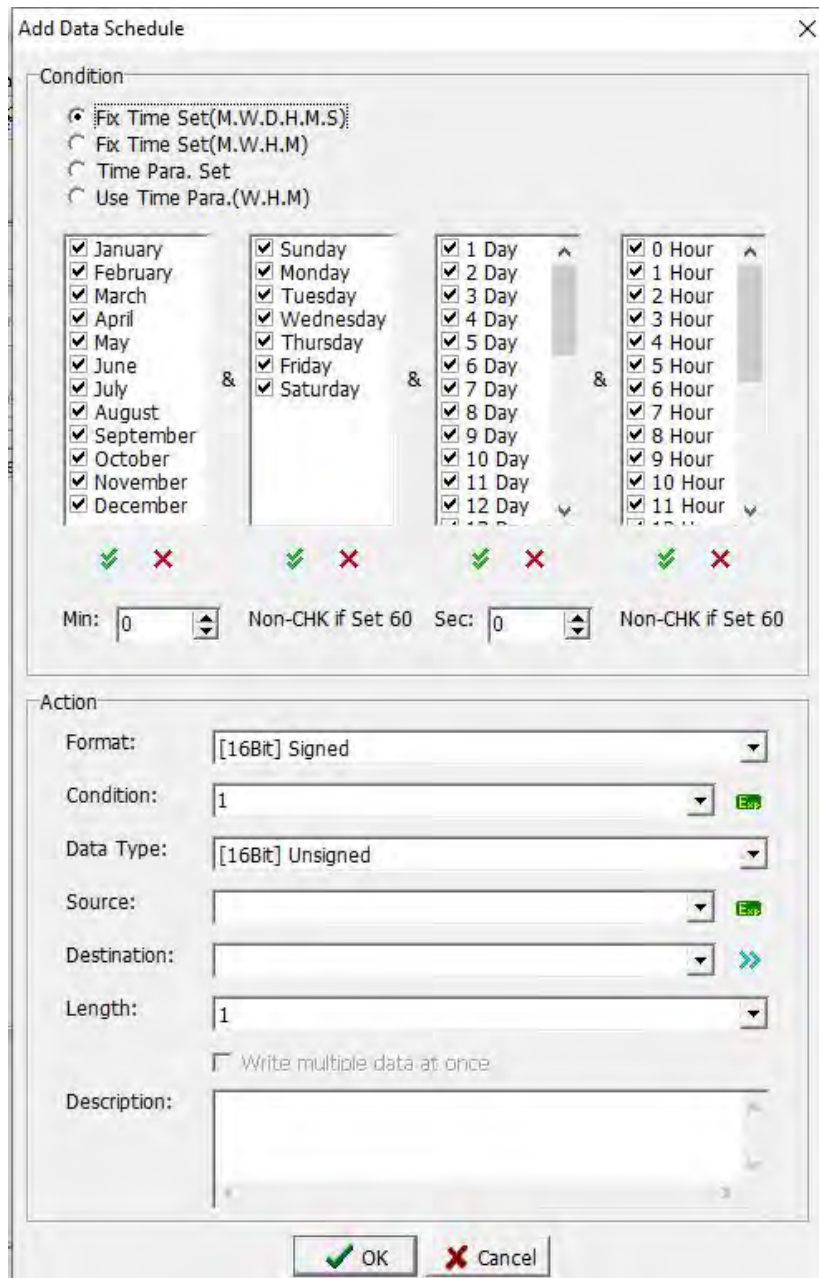

Condition: Select the time condition of data scheduling, which can be set by four modes, which are explained separately below.

#### **Use fixed time setting (month, week, day, hour, minute, second)**

Check this option, the user can use the action to the nearest second to trigger. As shown in the above figure, the value of register D100 is passed to D101 at 0:20:37 on January 1 and August 4 of January and August. The setting method is shown in the figure above.

#### **Use fixed time setting (month, week, hour, minute)**

Check this option, the user can use the action trigger to the nearest minute or a period of time (to avoid the situation that the power is turned on after the set time point and the action is not completed), as shown in the picture, every Thursday in January When 0, transfer the value of register D100 to D101, the setting method is shown in the figure below. It should be noted that the

"minute" setting column needs to select all, so to avoid if only select 0 points, if the boot time is at 0: 1 or after, this action can still be completed.

### Use time variable settings (month, week, day, hour, minute, second)

Check this option, the user can choose the controller by himself, use a continuous register (8 Words) as the time variable, this option can change the time condition at any time through the variable setting, as shown in the following figure:

**Add Data Schedule**

**Condition**

Fix Time Set(M.W.D.H.M.S)  
 Fix Time Set(M.W.H.M)  
 Time Para. Set  
 Use Time Para.(W.H.M)

Time Para.: [16] [16]

Use Word(16Bit) Addr.  
 Error Resource String <8902>  
 +0 Month, Bit0=Jan., Bit11=Dec.  
 +1 Week, Bit0=Sun., Bit6=Sat.  
 +2 Day, Bit0=1'day, Bit15=16'day  
 +3 Day, Bit0=17'day, Bit14=31'day  
 +4 Hour, Bit0=0hr, Bit15=15hr  
 +5 Hour, Bit0=16hr, Bit7=23hr  
 +6 Minute  
 +7 Second

**Action**

Format: [16Bit] Signed

Condition: 1 [16]

Data Type: [16Bit] Unsigned

Source: D100 [16]

Destination: D101 [16]

Length: 1

Write multiple data at once

Description:

[OK] [Cancel]

### Use time variable setting (week, hour, minute)

Check this option, the user can select the controller by himself, and use a continuous register (3 Words) as the time variable. This option can change the time condition at any time through the setting of the variable, as shown in the following figure:

**Edit:** Click this button to re-edit the selected existing data schedule.

**Delete:** Click this button to delete the selected existing data schedule.

**Import:** Click this button to import the vdh file data stored in the computer into the HMI project.

**Export:** Click this button to export the data schedule in the HMI project to a computer and store it as a vdh file.

### 2.4.13 Recipe

After clicking [Recipe] under the [Project] menu, the following dialog box will pop up. Set the data recipe that the user needs to use. For detailed introduction and cases of specific recipe settings, please refer to Chapter 10 Recipe Management.

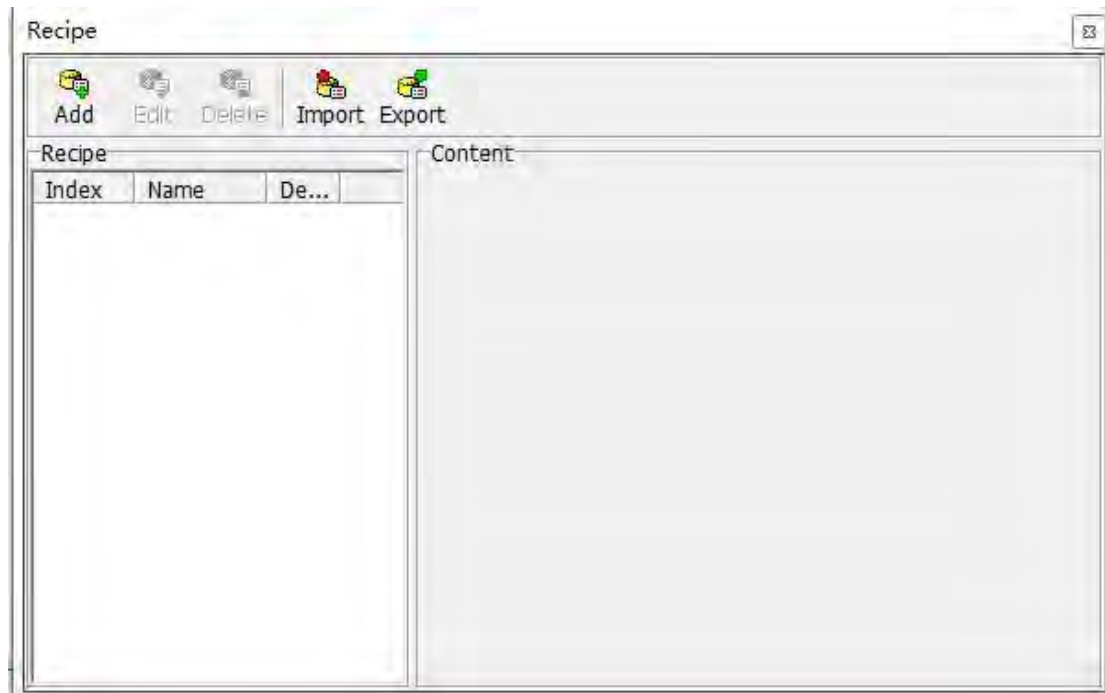

#### 2.4.14 System Configuration

After clicking [System Configuration] under the [Project] menu, the following dialog box will pop up. Can set the screen control and power saving mode.

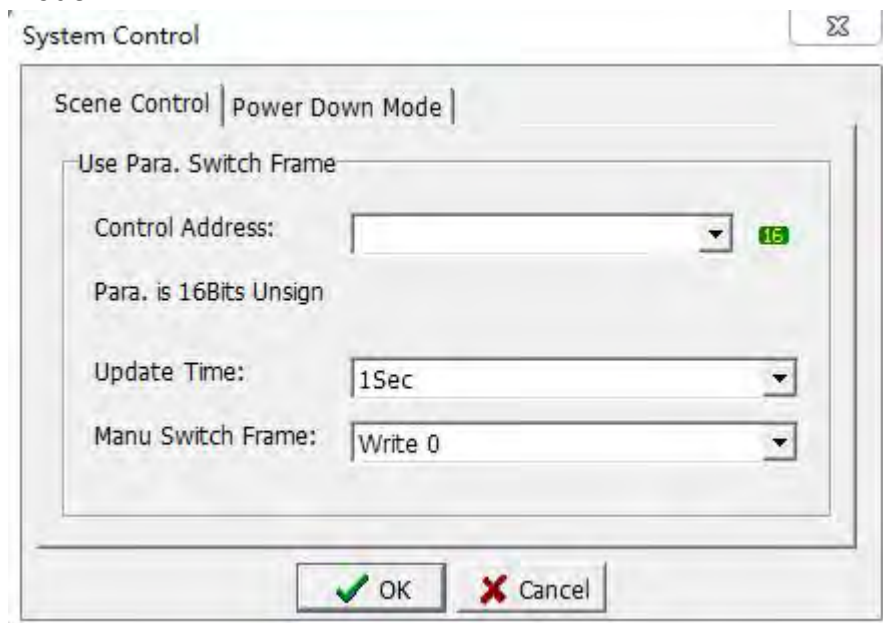

**Scene Control:** Set the variable, and control the automatic switching of the man-machine screen through the change of the variable data.

Control Address: select the variable address or label name to control the screen switching. The variable must be a 16-bit unsigned number.

Update Time: Set the update time of screen switching.

Manu Switch Frame: Set the variable value change after manual screen



switching, by "variable writing 0" and "variable writing switching screen ID (number)".

**Power Down Mode:** set whether the system uses power saving mode

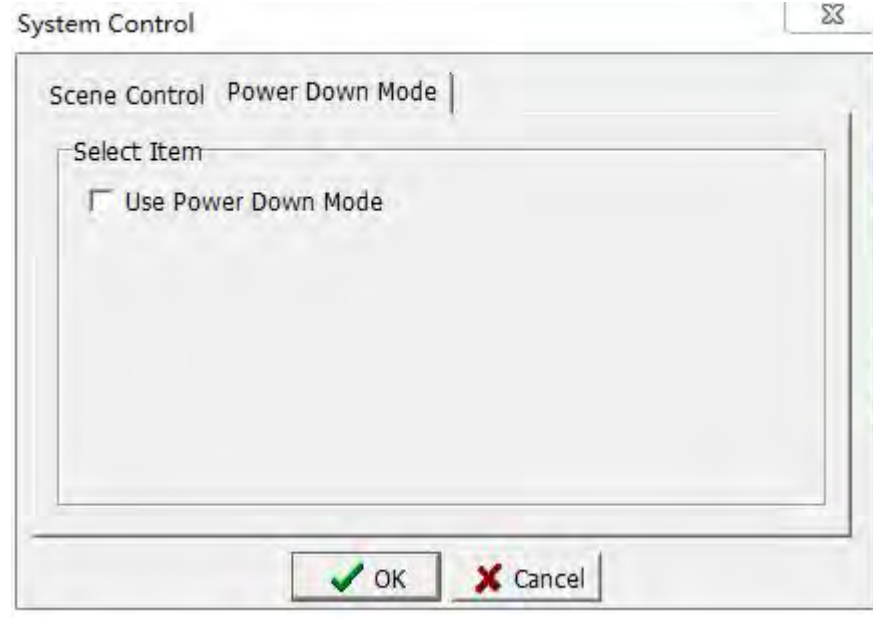

Use power saving mode: After checking this option, the items shown in the figure below can be set to set the time of power saving mode.

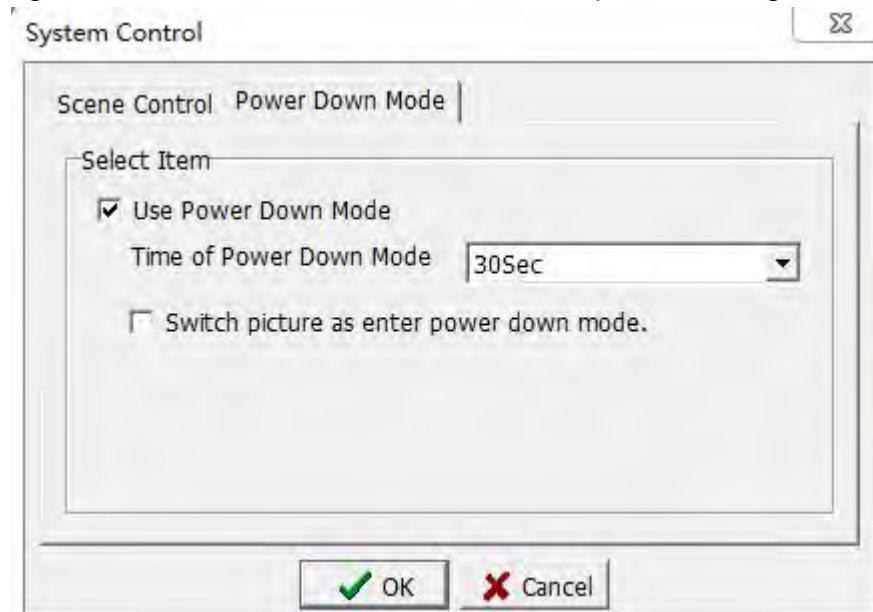

Switch screens when entering power saving mode: After checking this option, the settings shown in the figure below appear.

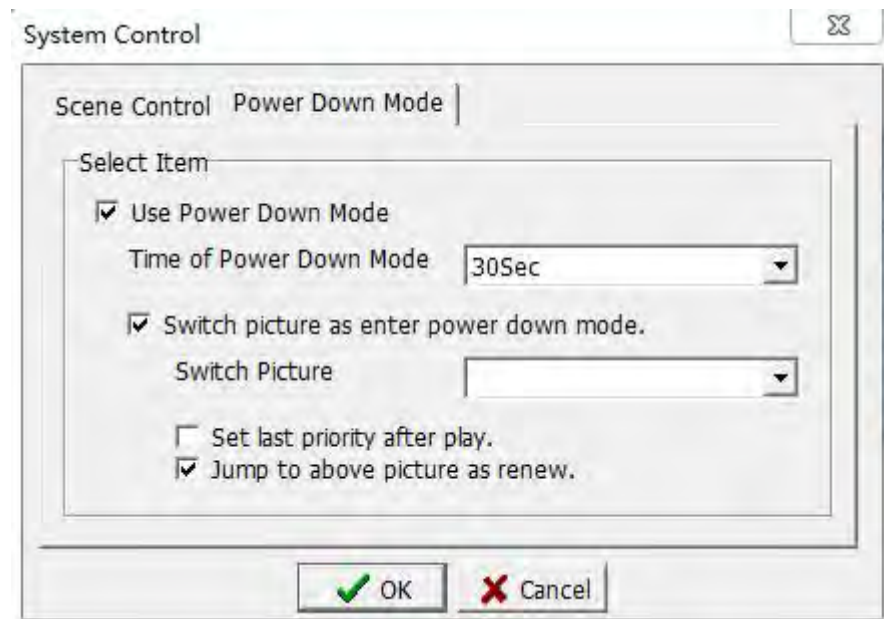

Screen switch: Select the screen to switch to when entering the power saving mode.

After the action, set to the lowest operation authority: After checking this option, when entering the power saving mode, the operation authority is set to the lowest.

When recovering, jump back to the previous screen: After checking this option, touch the screen in the power saving mode to jump back to the previous screen when the screen is switched.

### 2.4.15 Macro

Click [Macro] under the [Project] menu, as shown in the figure below, you can select the macro to be set to write the macro. The preparation of specific macro instructions and case introduction, please refer to Chapters 11 and 12 for details.

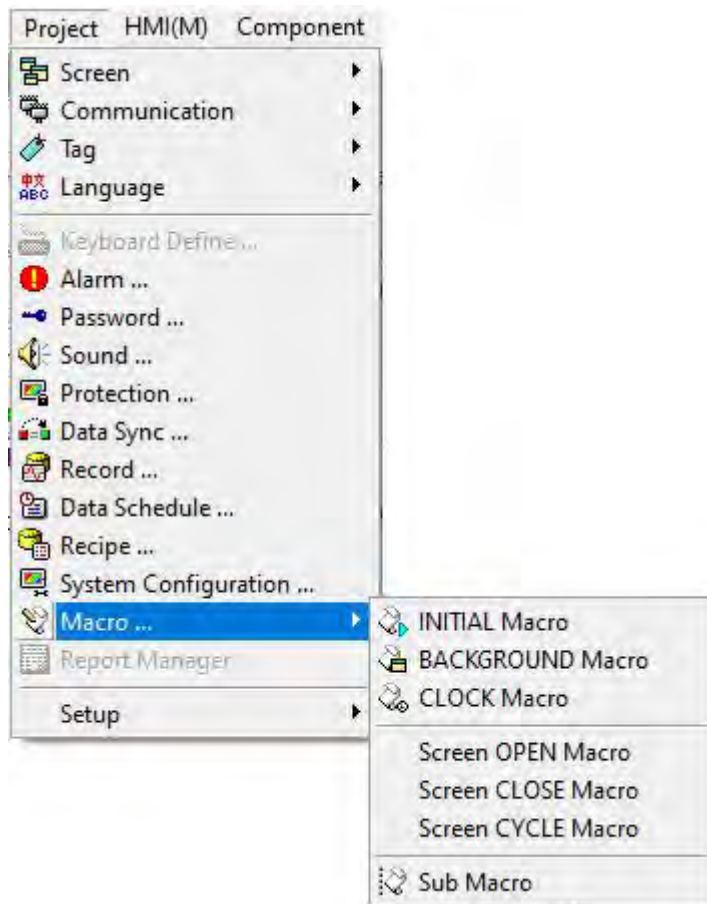

## 2.4.16 Report Manager

This model does not have this function temporarily.

## 2.4.17 Setup (Station ID / Model)

### Station ID

Click [Setup]-> [Station ID] under the [Project] menu to open the station number setting dialog box as shown in the figure below. In general use, the man-machine interface can be master or slave. This product provides a total of 191 (0 ~ 190) groups of Master station numbers for users. Group) station number, you can set multiple display units to use in the same group.

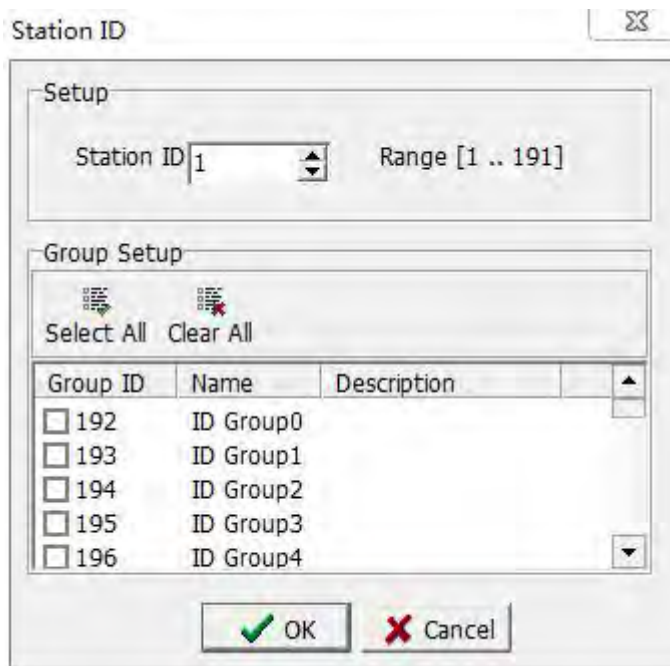

### Model

In general use, planning a human-machine interface solution is very time-consuming, so the engineer will choose to modify or apply the previously used solution. If you need to modify the model when using different models, click [Setup]-> [Model] under the [Project] menu to open the conversion model inquiry dialog box as shown in the figure below.

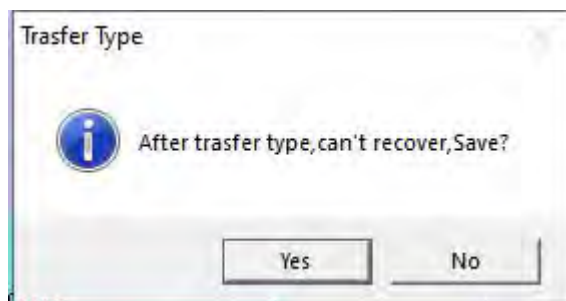

Selecting the [Yes] button will save the unconverted project, and selecting [No] will not save anything, and a dialog box for modifying the model, number and other information as shown in the figure below will pop up directly.

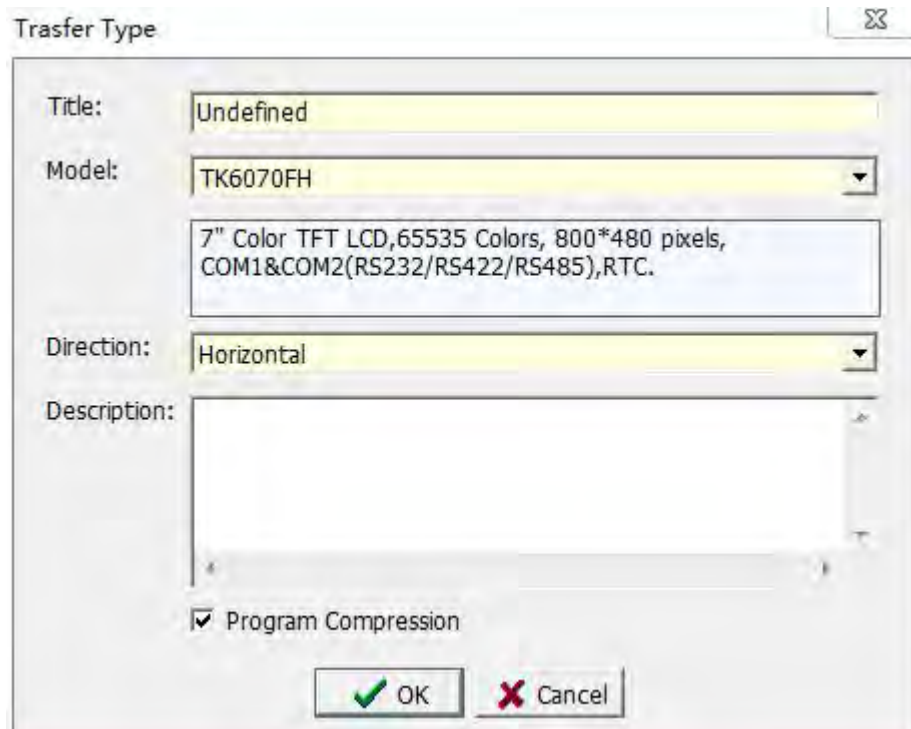

After inputting the project title, model number and display direction of the new project, click the [OK] button to pop up the dialog box as shown in the figure below. You can click the corresponding button to replace the project as required.

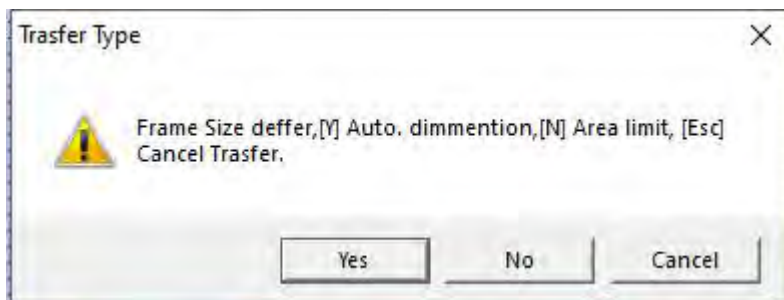

## 2.5 HMI

Use the mouse to directly click [HMI], or use the keyboard to press [ALT] + [M], the drop-down menu of [HMI] will appear, as shown in Figure 2-5.1. In order to facilitate users to quickly select, shortcut icons are also provided in the toolbar, as shown in Figure 2-5.2.



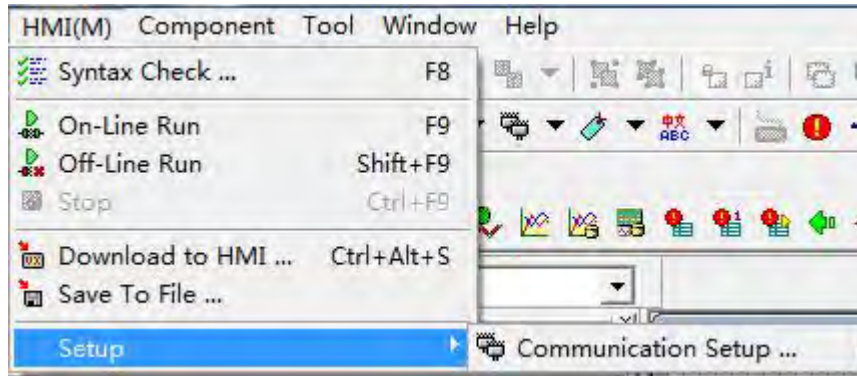

### 2-5.1



### 2-5.2

(1)	Syntax Check
(2)	On-Line Run
(3)	Off-Line Run
(4)	Stop
(5)	Download to HMI

## 2.5.1 Syntax Check

Click [HMI] menu bar [Syntax Check] or directly press the shortcut key [F8] or directly click the toolbar icon . When running [Syntax Check], check whether the variable names or settings are correct during the compilation of each screen in the project, and provide error information in the [Grammar CHK], so that we can eliminate the error information. In addition, the [Syntax CHK Mes.] dialog box will pop up, displaying information such as memory usage, data type ratio, memory font data, etc., for the user to refer to when editing. As shown below:

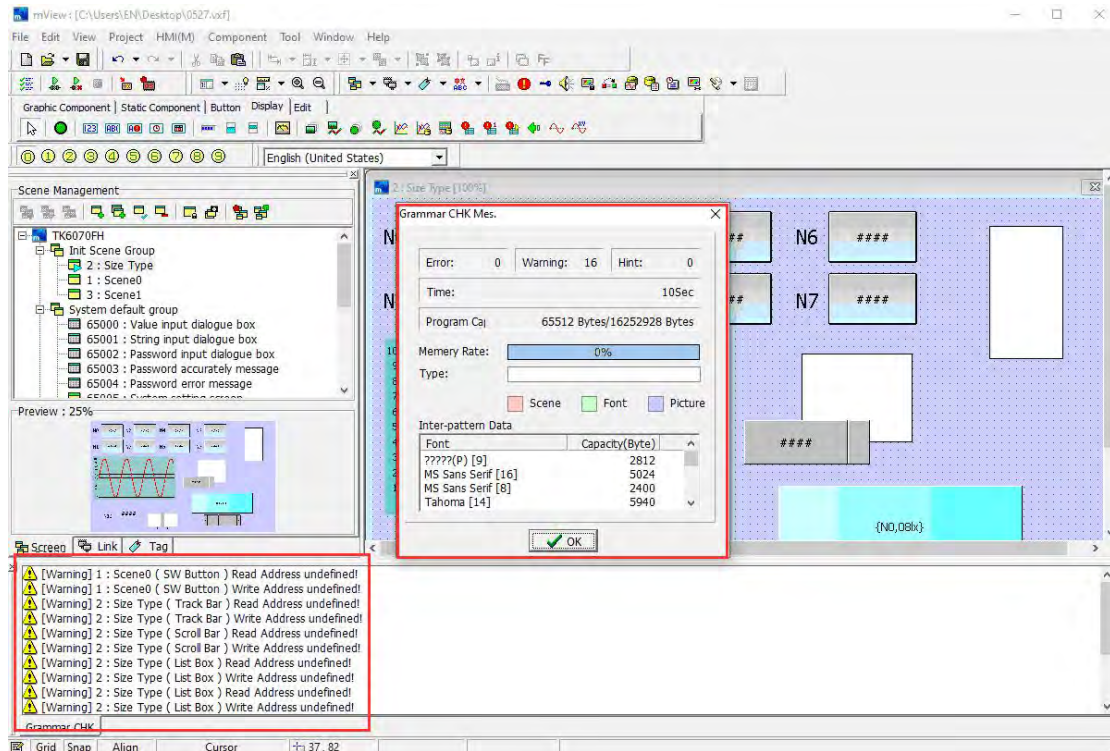

## 2.5.2 On-Line Run

Click [HMI] menu bar [On-Line Run] or directly press the shortcut key [F9] or directly click the toolbar icon . Execution of this function requires actual connection with the controller, and during execution, the project will modify the corresponding variable register set by the controller to verify whether the set controller action can be performed normally.

Before [On-Line Run], you need to set the communication, click [HMI] menu bar [Setup]-> [Communication Setup], the communication port setting in the upload / download page refers to the use of the designated PC Which port of the terminal is connected to the display unit. The communication port setting in the emulation communication setting page refers to the communication port on the display unit. Screenshots of the two pages are shown below.

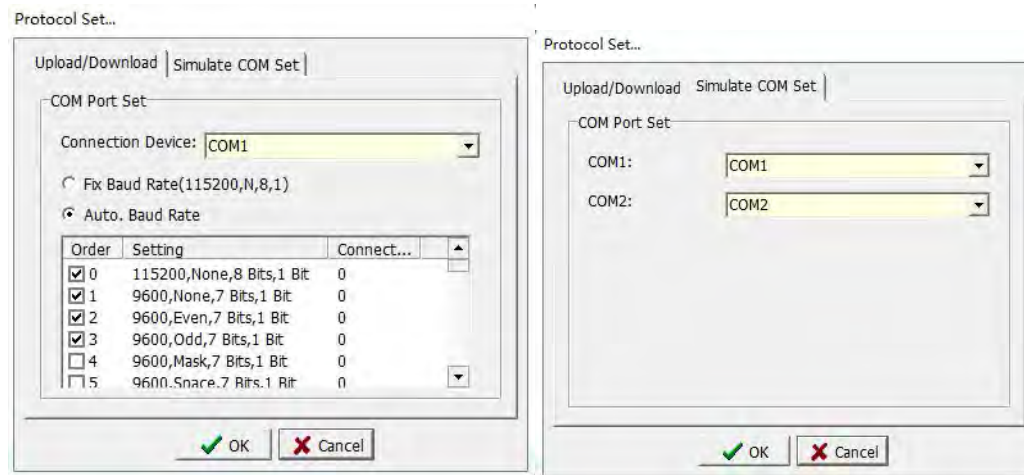

### 2.5.3 Off-Line Run

Click [HMI] menu bar [off-Line Run] or directly press the shortcut key [shift + F9] or directly click the toolbar icon . When using this function, there is no need to connect with the actual man-machine interface, so that the customer can use it to check whether the project can be executed normally and verify whether each function is correct.

### 2.5.4 Stop

When [Offline Execution] is not executed, this option is grayed out and cannot be selected. This option is highlighted when the offline execution of the computer needs to be ended. You can click [HMI] menu bar [Stop] or directly press the shortcut key [Ctrl + F9] or click the toolbar icon  directly. Stop the execution of offline.

### 2.5.5 Download to HMI

Before downloading the project to the HMI, you need to set up the communication settings first. Here you can refer to the communication settings in 2.5.2 online execution.

After the project is completed, you need to download the project to the HMI. You can click the [HMI] menu bar [Download to HMI] or directly press the shortcut key [Ctrl + Alt + S] or directly click the toolbar icon . The dialog box shown below is displayed.

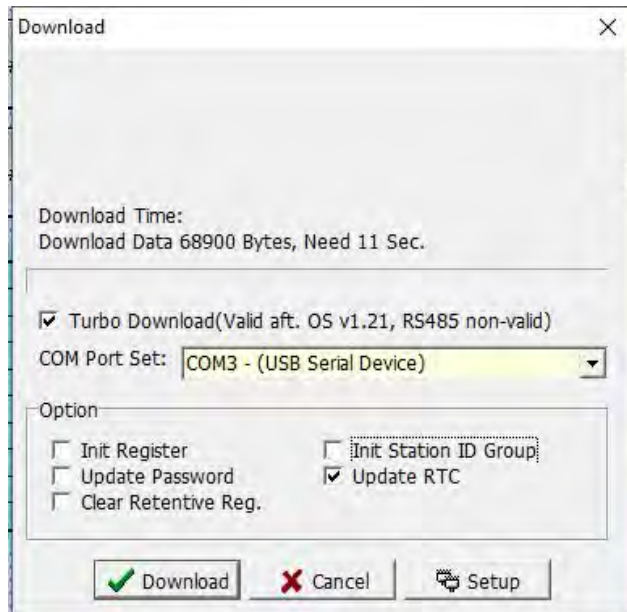

**Turbo Download:** After checking, the download speed is faster.

**Com Port Set:** Here, select the PC port where the host PC and HMI are connected.

**Init Register:** After checking, the buffer is initialized when downloading.

**Update Password:** After checking, the password table will be updated when downloading.

**Clear Retentive Reg.:** After checking, the data in the power-off retention buffer will be cleared when downloading..

**Init Station ID Group:** After checking, the station number group setting will be updated when downloading.

**Update RTC:** After checking, set the HMI time to be the same as the computer time when downloading.

**[Download]:** Click the download button to download the program to the HMI.

**[Cancel]:** Click the Cancel button to cancel the download of the program.

**[Setup]:** Click the setting button, a communication setting dialog box pops up to set upload / download and COM port.

### 2.5.6 Save To File

In addition to downloading the created program directly to the HMI, the software also provides a specific project to save the user-made program as a suffix (.vho) for users to download the program.

Note: if unchecked the menu bar [View]->[Option...]->[File]->[Add Decompiled Information], then this file of (.vho) can only be downloaded, and the program cannot be modified.

Click the [HMI] menu bar [Save project to file], a dialog box will pop up shown as below. Click the [Save] button to save the project as a HMI specific file with the extension (.vho). Click the [Cancel] button.

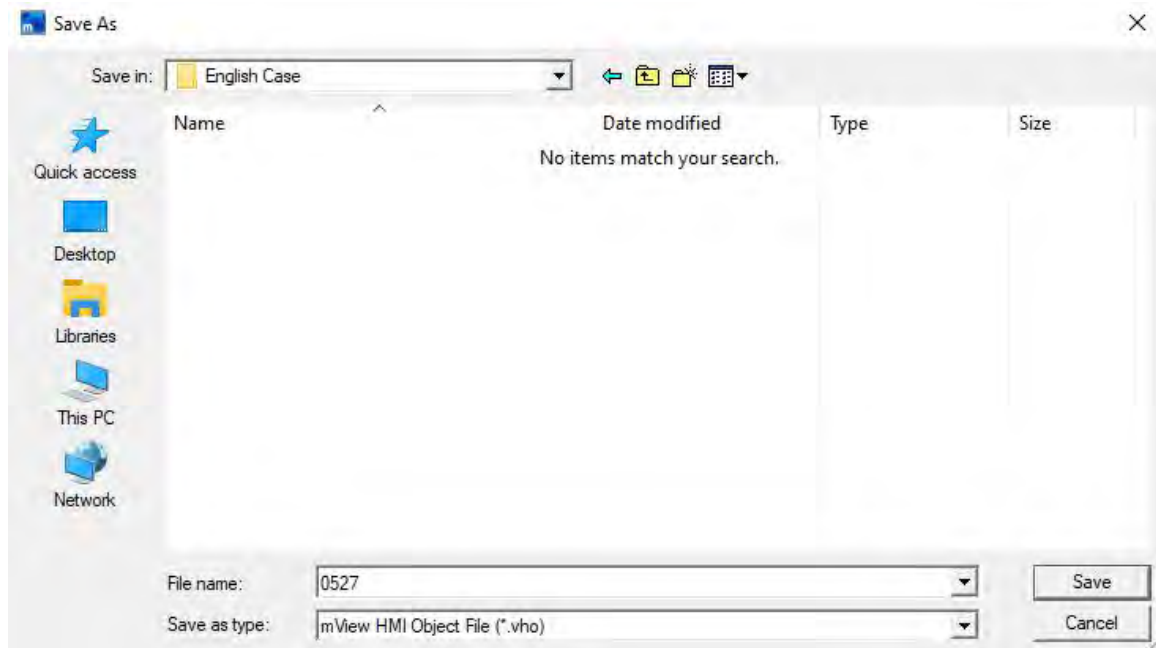

If you need to download this program to the HMI in the future, you can click the [Download HMI program ...] under the [Tools] menu to select the desired file with the suffix (.vho) to download to the HMI Interface.

## 2.5.7 Setup

Click [Setup]-> [Communication Setup] under the menu bar of [HMI], and a dialog box as shown below will pop up.

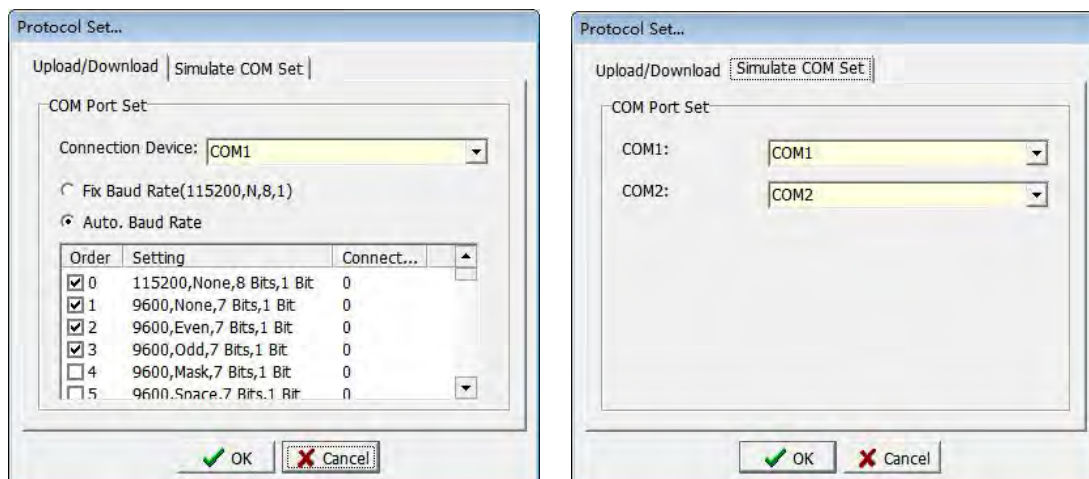

## Upload/Download

**Connection Device:** Set the COM port of the computer that the display unit is connected to.

**Fixed Baud Rate (115200, N, 8, 1):** Select this option to use only this communication rate to communicate with the PLC.

**Auto. Baud Rate:** Select this option, you can select multiple speeds. When



the HMI communicates with PLC, you can use the selected speed for communication.

### Simulate COM Set

COM1: Select the COM port on the computer.

COM2: Select the COM port on the computer.

After the simulation communication setting is completed, select [HMI (M)]-> [Online Simulation] to enable the PC to communicate with the controller as an HMI, so that the user can check whether the set function has achieved the desired effect.

After the COM1 / COM2 settings on this page is completed, the communication tap in the software is shown as below.

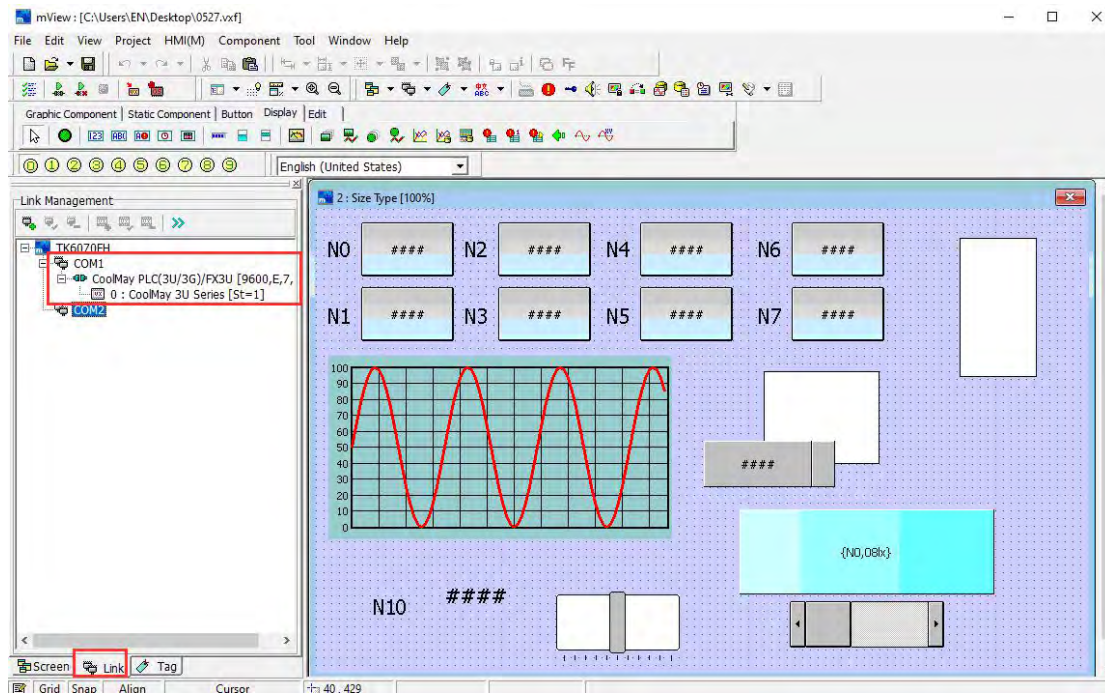

## 2.6 Component

Click [Component], or press [ALT] + [C], the [HMI] drop-down menu appears, as shown in Figure 2-6.1. In order to facilitate users to quickly select, shortcut icons are also provided on the toolbar, as shown in Figure 2-6.2.

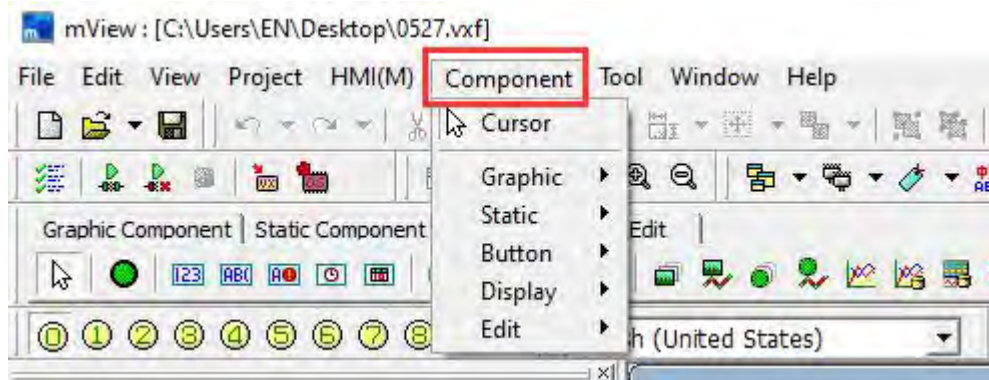

## 2-6.1



## 2-6.2

For the use of each component, refer to Chapter 3 [Component] for details.

## 2.7 Tool

Click [Tool], or press [ALT] + [T], then the [Tool] drop-down menu will appear, as shown in figure 2-7.1.



## 2-7.1

### 2.7.1 Download HMI...

Click the [Download HMI program ...] option under the [Tool] menu bar, and the dialog box shown below will pop up. The purpose is to download the saved file with the suffix name (.vho) from the HMI. The file is for download only and cannot be modified.

Create a (.vho) file, click the [Save Project to File ...] option under the [HMI] menu bar, and the current project will be saved as a (.vho) file to the user-specified location.

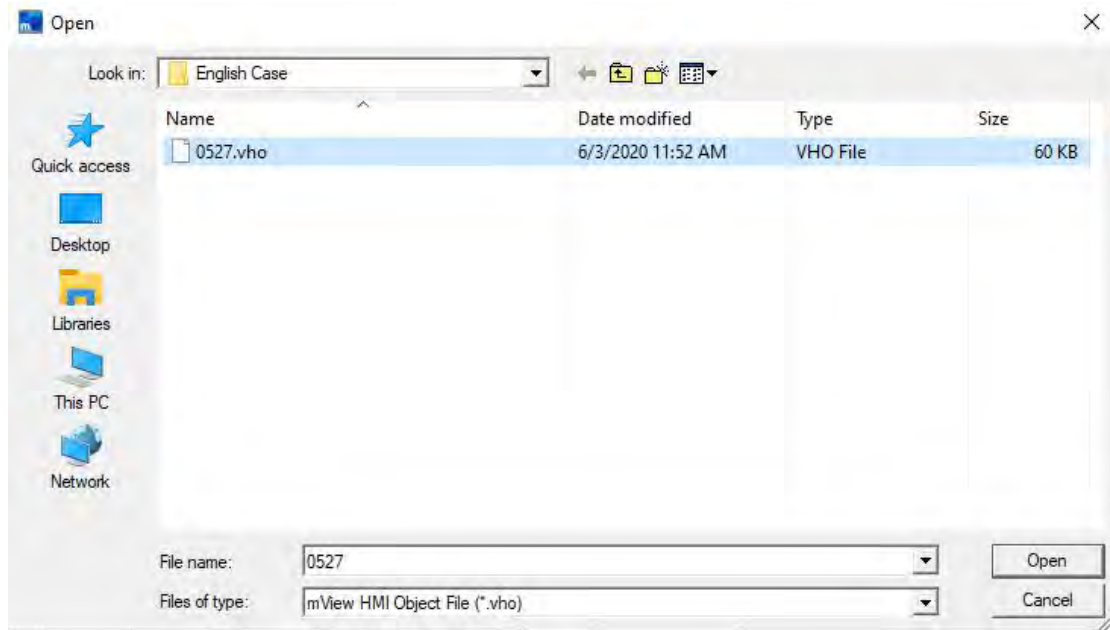

After selecting the (.vho) file to be downloaded, select and click the [Open] button. The following download dialog box pops up. After selecting the correct port number, click the [Download] button.

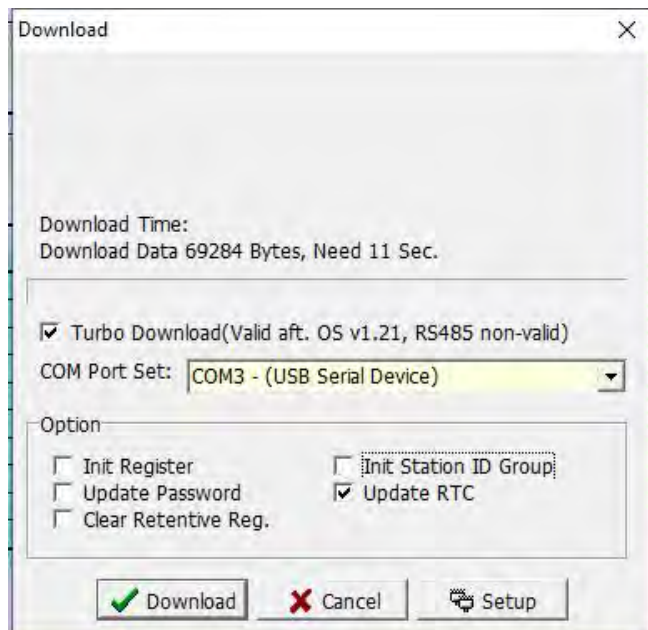

The project download process is shown below.

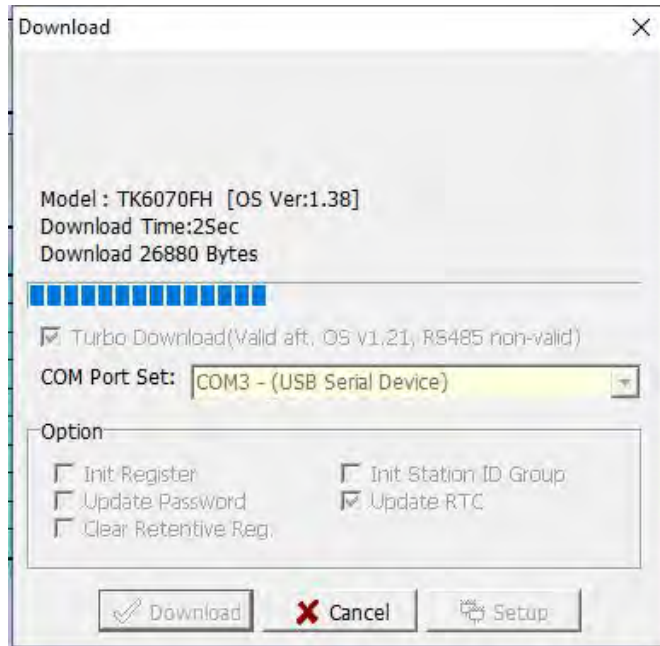

After the download is complete, click the [Finish] button to complete the download process.

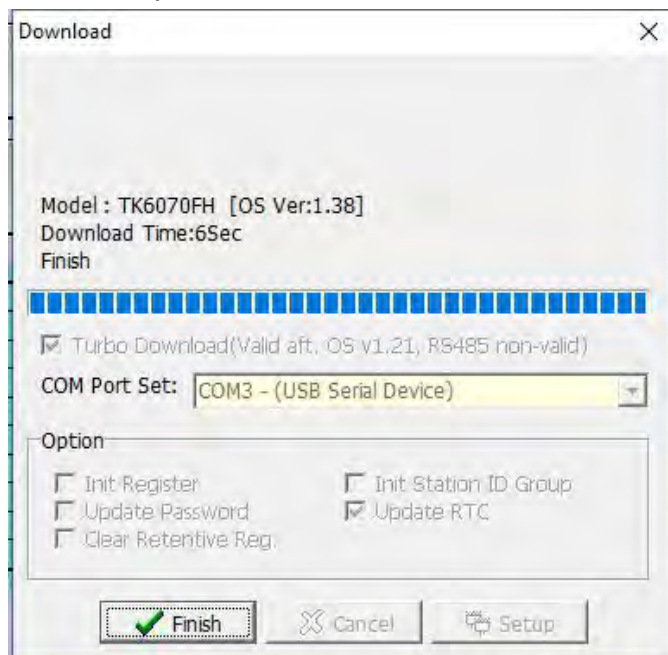

### 2.7.2 Upload HMI...

Use this function to read the project in the HMI to the PC and save it as HMI project for modification and subsequent download. Click the [Upload HMI Program ...] option under the [Tool] menu bar, a dialog box as shown in the figure below pops up. After selecting the correct communication port, click the [Upload] button.



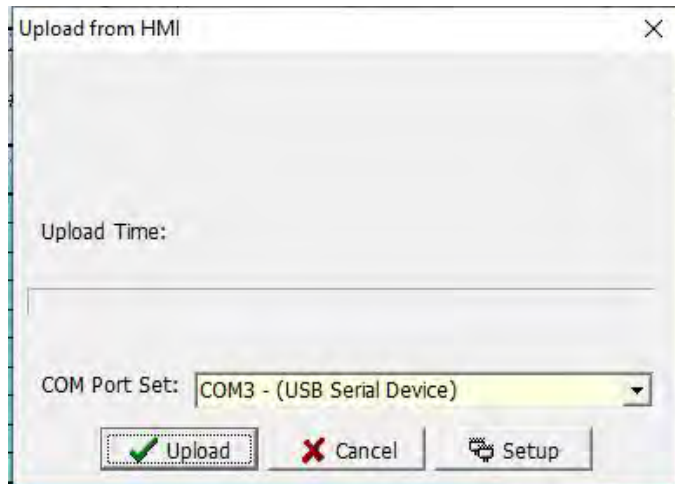

After selecting and clicking the [Upload] button, if an upload password is set in the program, the following password input screen will pop up:



Input password and click [Confirm], an upload picture will be shown as below.

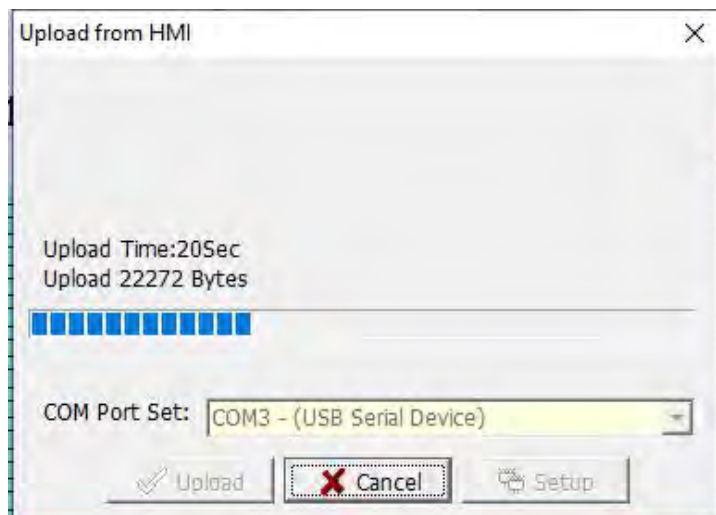

After the transfer is completed, the user will be asked to save the project as a dedicated project with the suffix (.vho), as shown in the figure below.



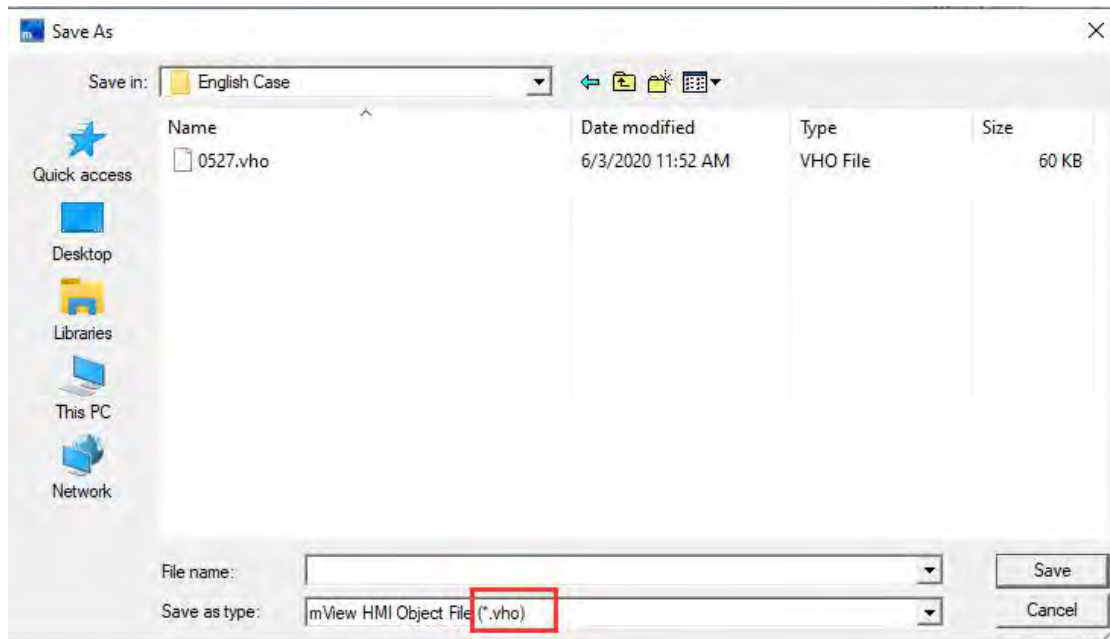

Select the path to save the (.vho) and click the [Save] button to save the file that read from the HMI. Click the [Finish] button in the upload program dialog box below, and the HMI reads the program is finished.

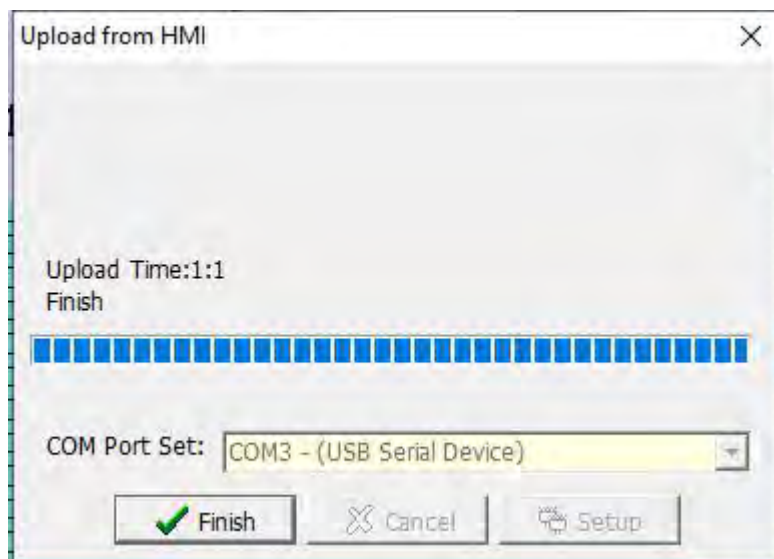

### 2.7.3 Update HMI OS...

For this software, if the new mView software version is released, it will be matched with the corresponding version of the OS. The role of the OS is to the software compatible with the lower computer. If users need to use the functions provided by the new software version, they need to use the new version of the OS. The download steps of the HMI OS are as follows.

1. Click [Update HMI OS ...] in the [Tool] menu bar, shown as below.

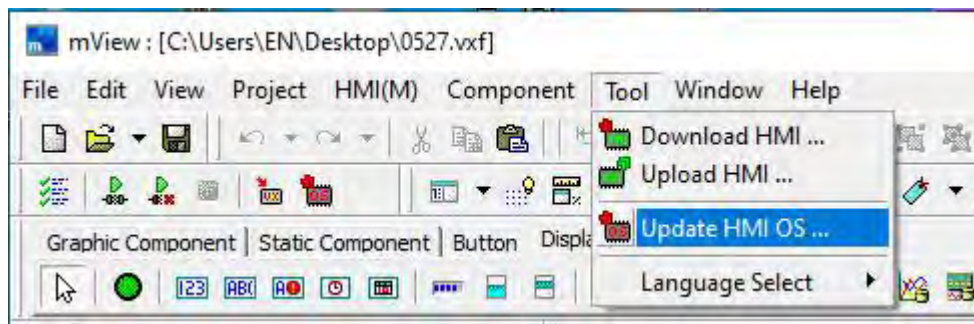

2. In the pop-up dialog box, select the OS version to update, as shown in the figure below. It is recommended to update as the software version of the host computer used.

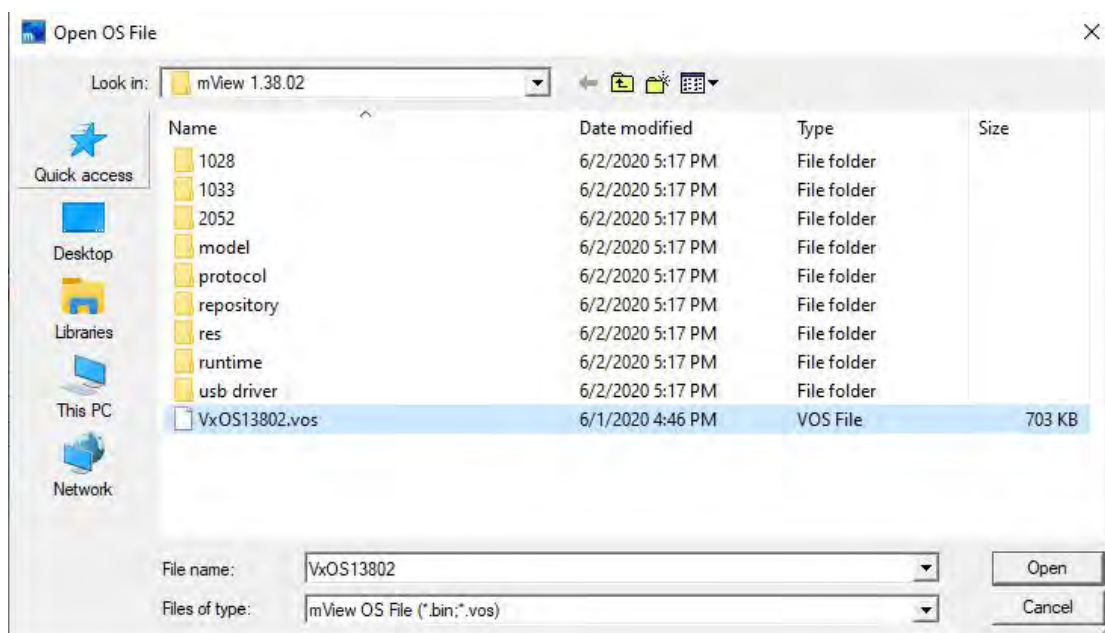

3. After selecting the OS file, click the [Open] button, the following dialog box pops up, click the [Update] button to start updating the OS system.

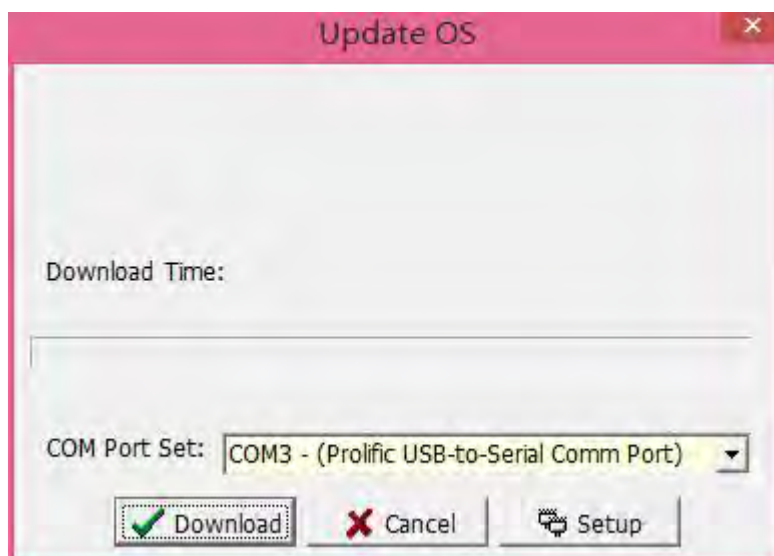

4. The update process is shown as below.



5. After the update is completed, you need to power on the display unit again, the following prompt box pops up, click [OK].



## 2.7.4 Language Selection

There are three editing software languages available, [Chinese (Traditional)], [English], [Chinese (Simplified)]. The software for each language is shown below.

### [Chinese (Traditional)]

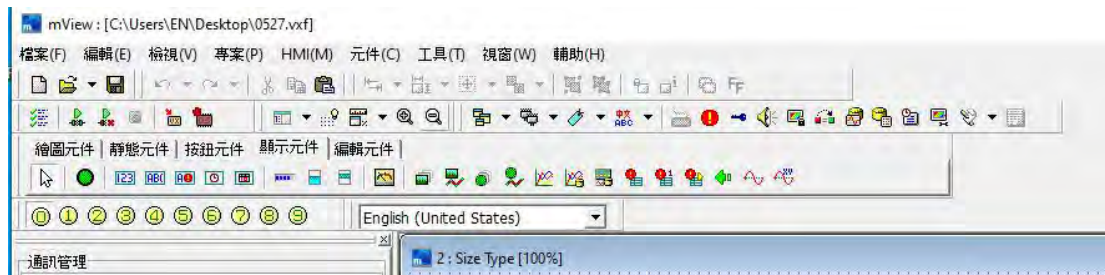

### [English]

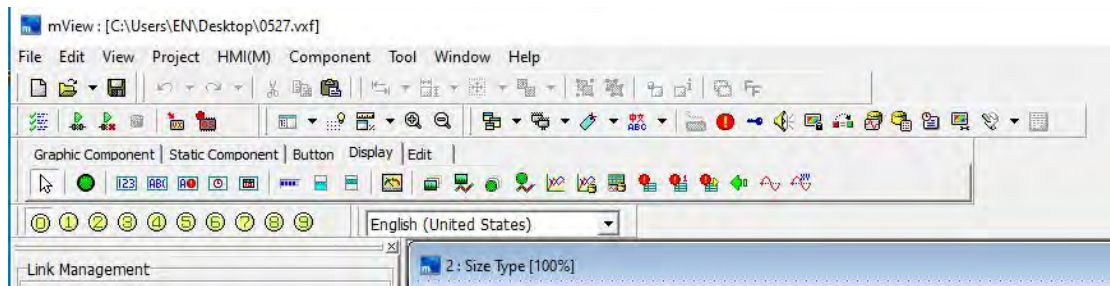

## [Chinese (Simplified)]

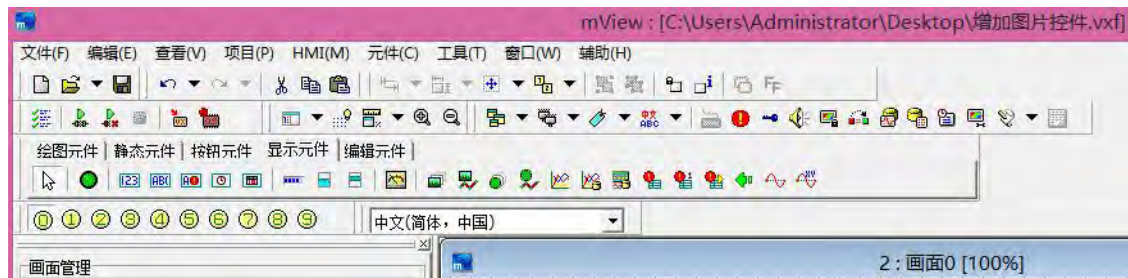

## 2.8 Window

Click [Window], or press [ALT] + [W], the drop-down menu of [Window] appears, as shown in Figure 2-8.1.

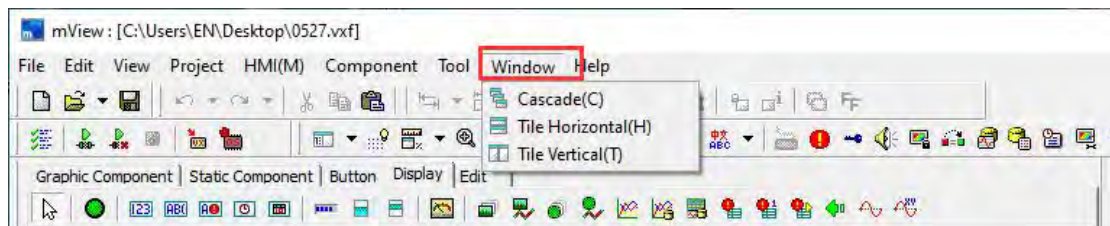

2-8.1

When you need to use multiple screens in a project, in order to facilitate viewing and editing, you can select this way to edit the screen, as shown in the following figure, you can choose [Cascade], [Tile Horizontal], and [Tile Vertical].

### [Cascade]



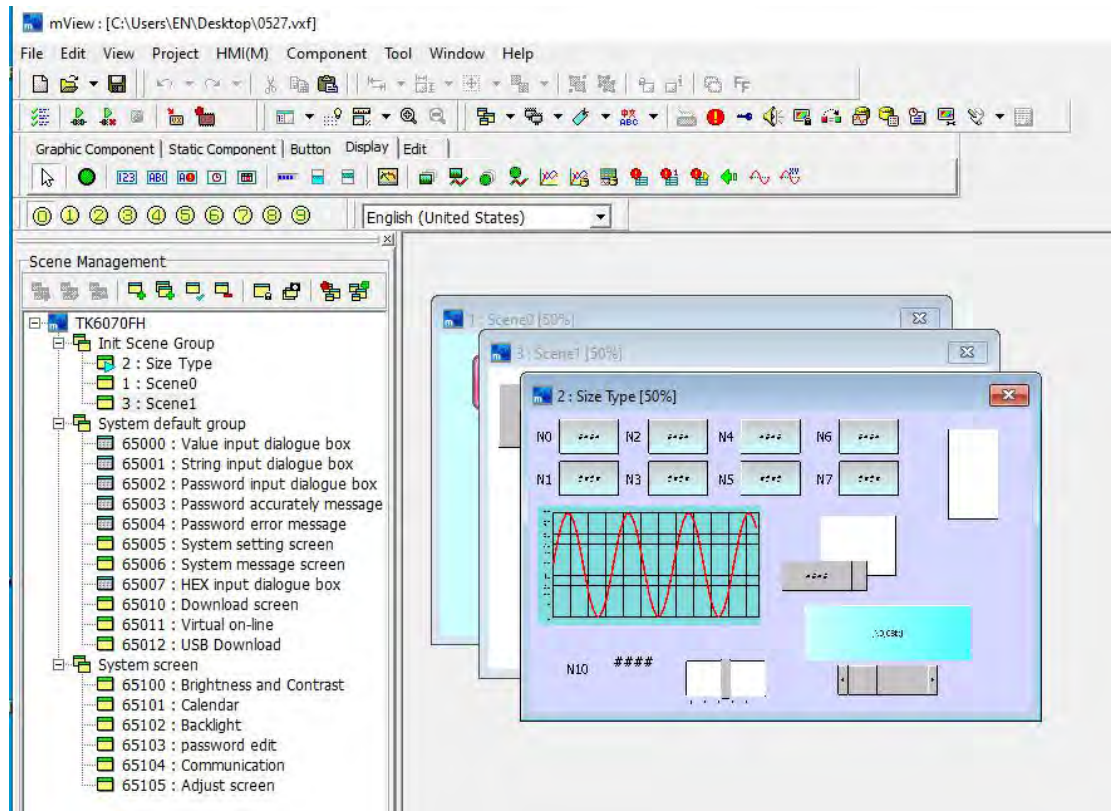

[Tile Horizontal]

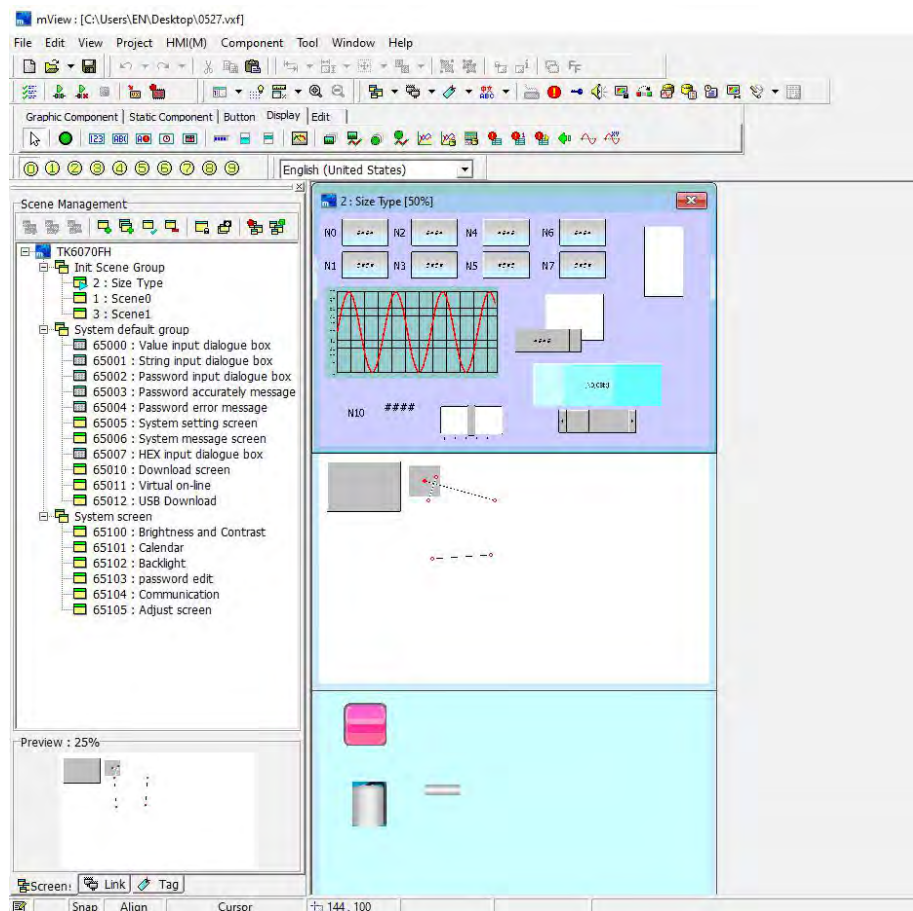



## [Tile Vertical]

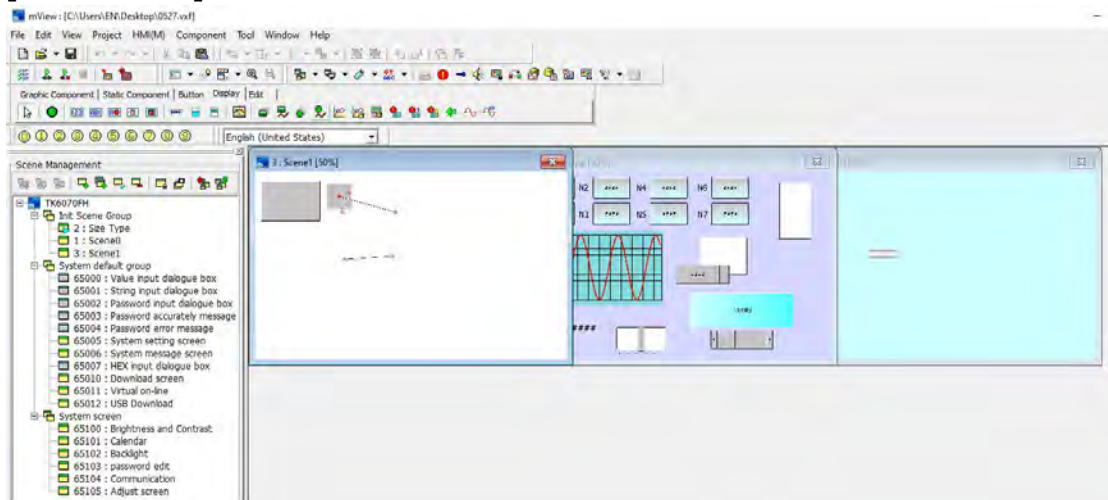

## 2.9 Help

Click [Help], or press [ALT] + [H], the [Help] drop-down menu appears, as shown in Figure 2-9.1.



2-9.1

Click [mView Help], pop up the user manual of this software. Users can find related contents.

Click [About...], the software version will appear, as shown in the figure below. Please pay attention to whether it is the latest version. If you have any questions, please contact us.



## Chapter 3 mView Component Function Description

The components provided by this software are divided into the following five categories:

1. [Graphic].
2. [Static].
3. [Button].
4. [Display].
5. [Edit].

### 3.1 Graphic

To use a graphic component, you can click [Graphic] under the [Component] menu bar, and the drop-down options appear, as shown in the following figure 3.1-1, or you can directly click this option on the shortcut bar of the tool, as shown in the following figure 3.1-2 Shown

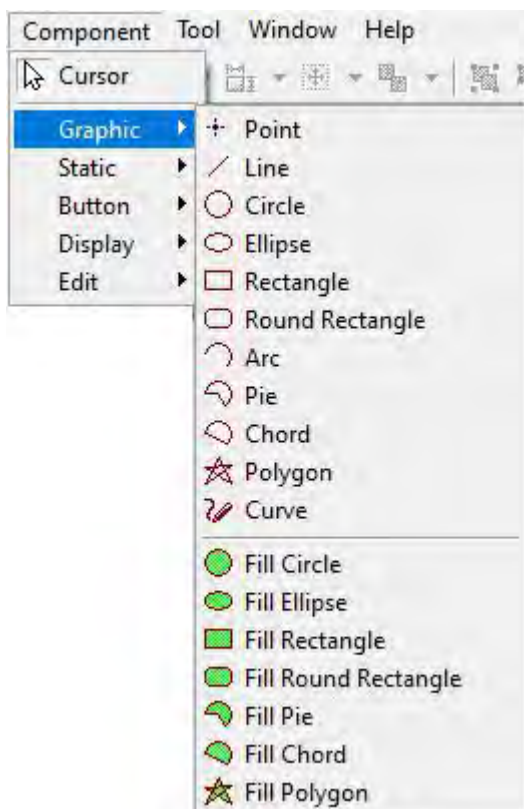

3.1-1



3.1-2

Select the component you need. Click the component and press the right

mouse button to select the object properties, or double-click the mouse directly on the component to be edited, the component property settings appear. The [Point] and [Line] property window are shown as below:

**Style:** The display of point or line is available.

**Color:** Modify the color of the component.

**Position:** X1 / Y1 represents the leftmost point of [Line], X2 / Y2 represents the rightmost point of [Line].

**X:** Modify the coordinates of X so that the component X coordinates move to the modified X coordinates.

**Y:** Modify the coordinates of Y so that the component Y coordinates move to the modified Y coordinates.

The properties of other components are the same. There is an example here.

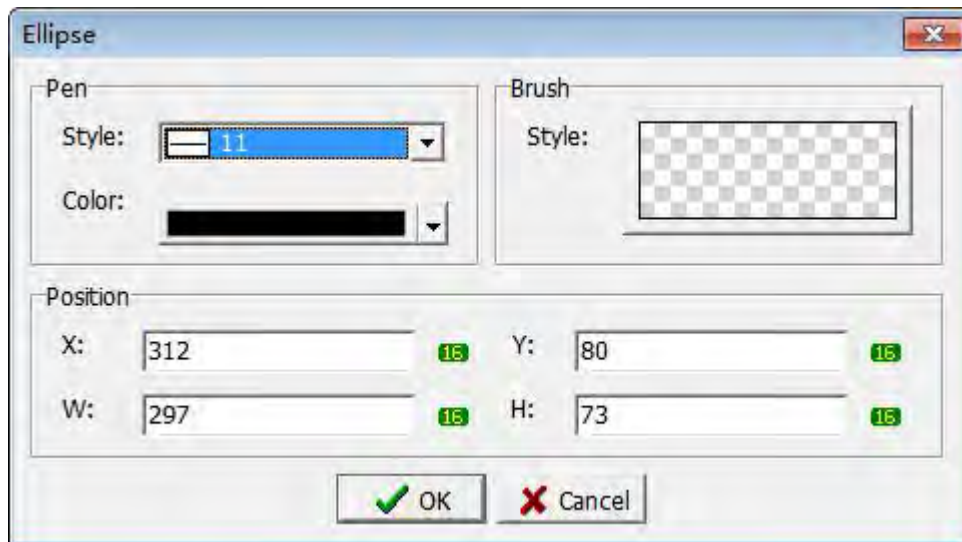
**Pen:**

Style: Select the style of the ellipse frame.

Color: Select the color of the ellipse frame.

**Brush:**

Style: display and set the style of ellipse inner frame.

**Position:**

X: Enter the X coordinate position of the ellipse element.

Y: Enter the Y coordinate position of the ellipse element.

W: Enter the width of the ellipse element.

H: Enter the height of the elliptical element.

**3.1.1 Brush Settings**

The previous section introduces brushes. This section explains the brush setting steps and details.

Click the preview image in the Brush Style, there will pop up the variable brush dialog box shown as below.

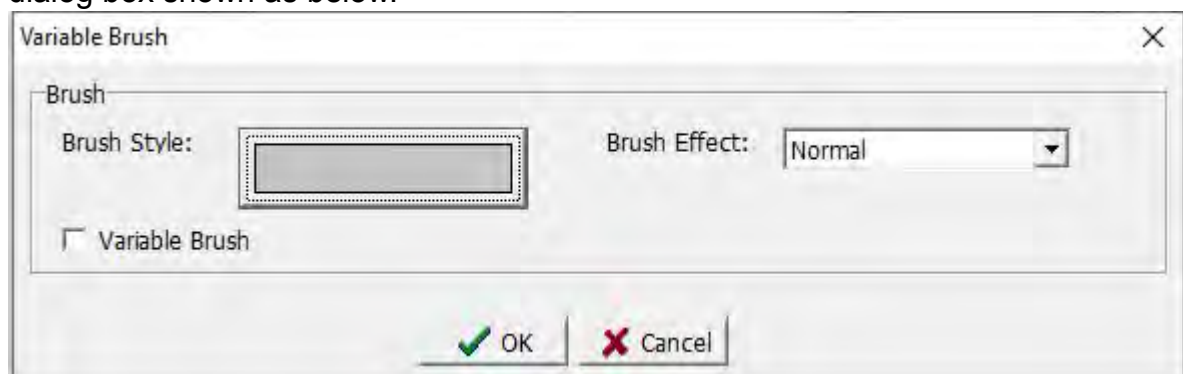

**Brush Effect:** Select normal or flash effect in the drop-down list.

Click the preview of the brush style, and the brush selection dialog box will pop up.

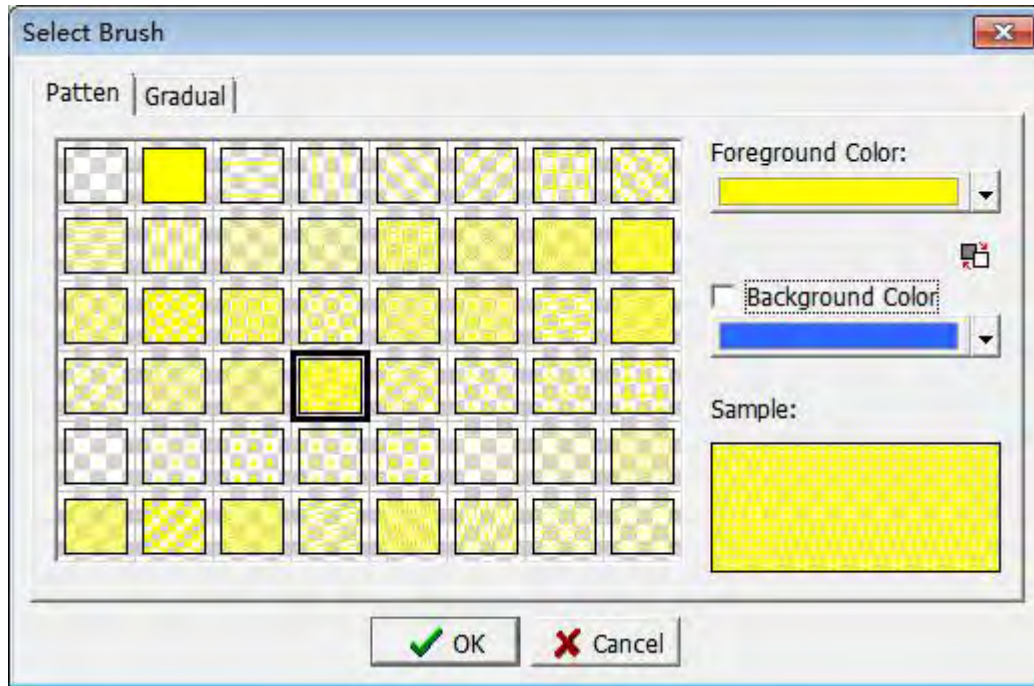

**Pattern:** Select the brush pattern to be displayed.

**Foreground Color:** set the brush pattern color.

**Background color:** Check the background color to display the background, otherwise there is no background color. Set the background color of the brush pattern.

**[OK]:** After setting, click [OK] to save the settings.

**[Cancel]:** Click [Cancel] to not save the selected settings.

**Variable Brush:** Check this option to set the parameters that control brush changes. The dialog box is shown below.



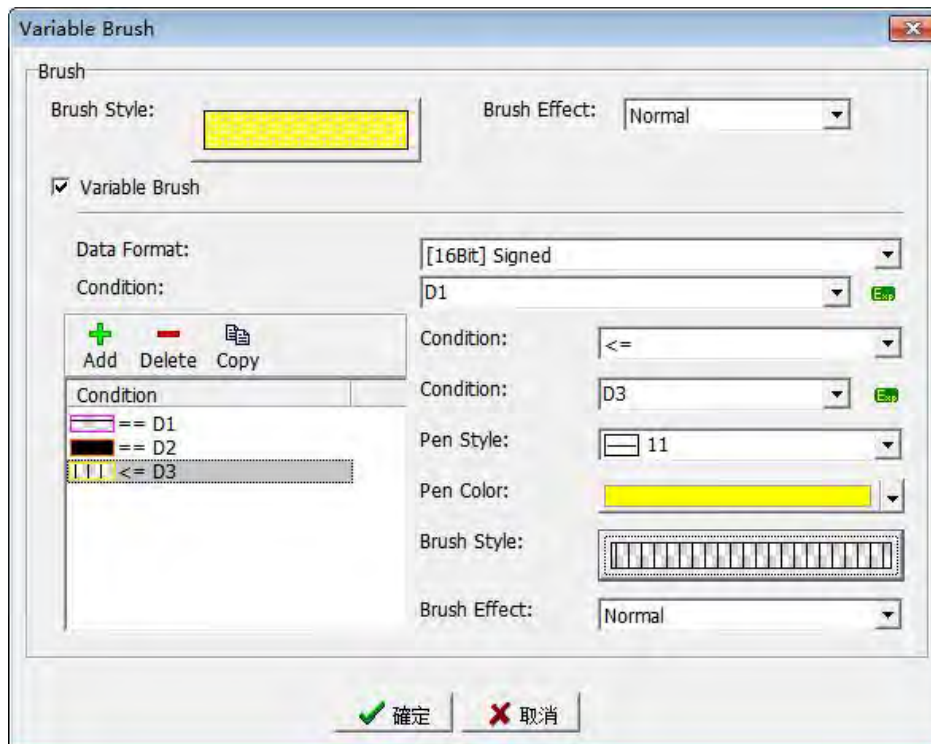

**Data Format:** Select the type of variable that controls the brush change.

**Condition:** Set specific variables.

**Condition:** Set the conditions of the brush changes, providing a total of six conditions to choose from: equal to, not equal to, greater than, equal to, less than, less than or equal to.

**Condition:** Set the contrast variable. As shown in the figure above, set D0 to display different brushes when compared with D1 / D2 / D3.

**Pen Style:** Select the style of the brush frame.

**Pen Color:** Select the color of the brush frame.

**Brush Style:** Select the pattern displayed by the brush.

**Brush Effect:** Select normal of flash effect.

**[OK]:** After setting, click [OK] to save the settings.

**[Cancel]:** Click [Cancel] to not save the selected settings.

### 3.2 Static Component

Click [Static] under the [Component] menu bar, and the drop-down option for the static component appears, as shown in the following figure 3.2-1, or you can directly click this option on the tool shortcut bar, as shown in the following figure 3.2-2 Shown

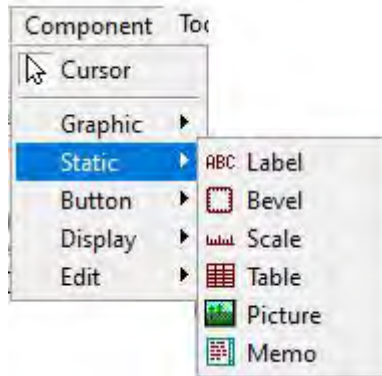

3.2-1

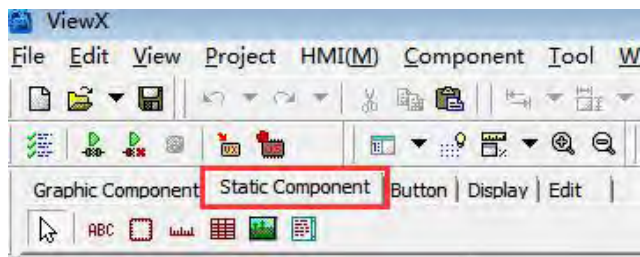

3.2-2

### 3.2.1 Static Bevel/ Text

After selecting the component to the editing area, right-click the mouse to select [properties], or double-click directly on the component to be edited, the properties of the component will appear, the static bevel and text property dialog boxes are shown in the figures below.

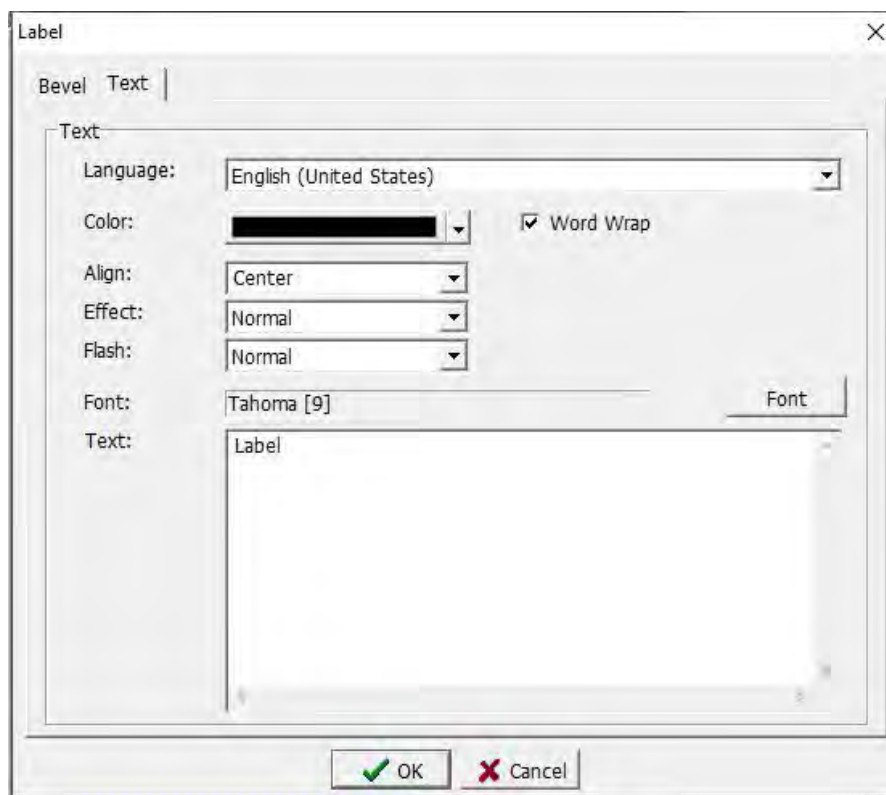
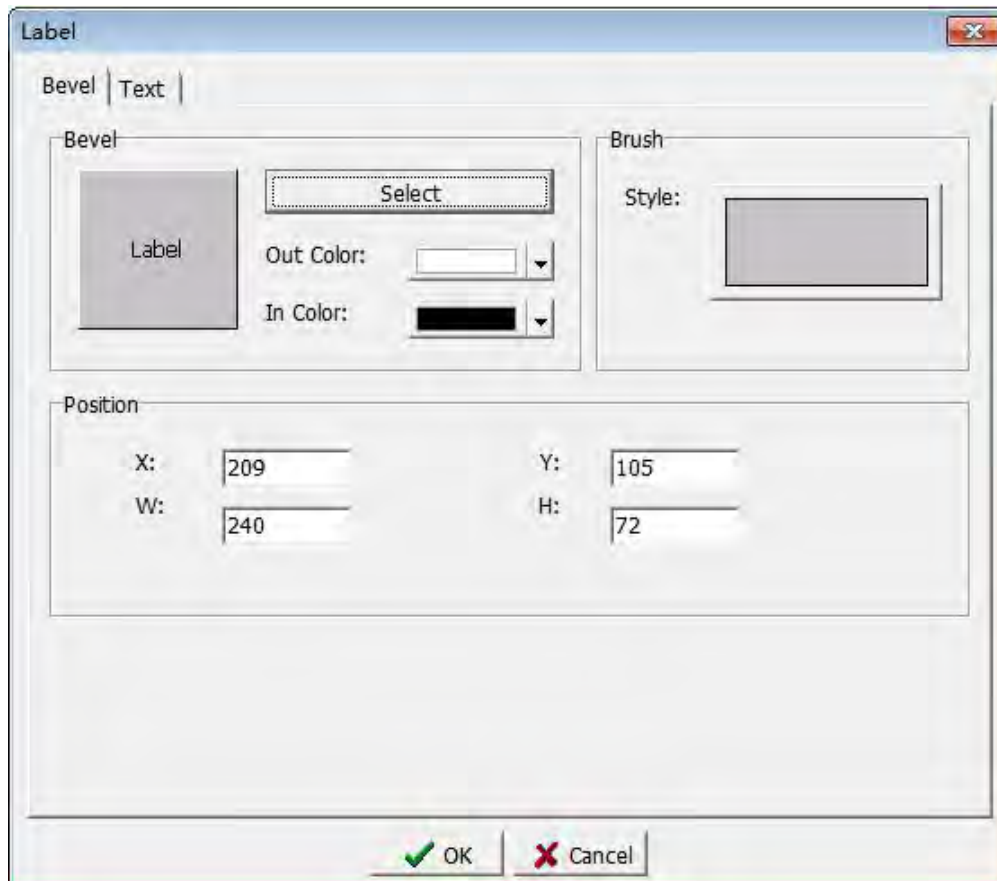

## Bevel

**Select:** Select the bevel style of the component, click [Select] to pop up the

box as shown below.

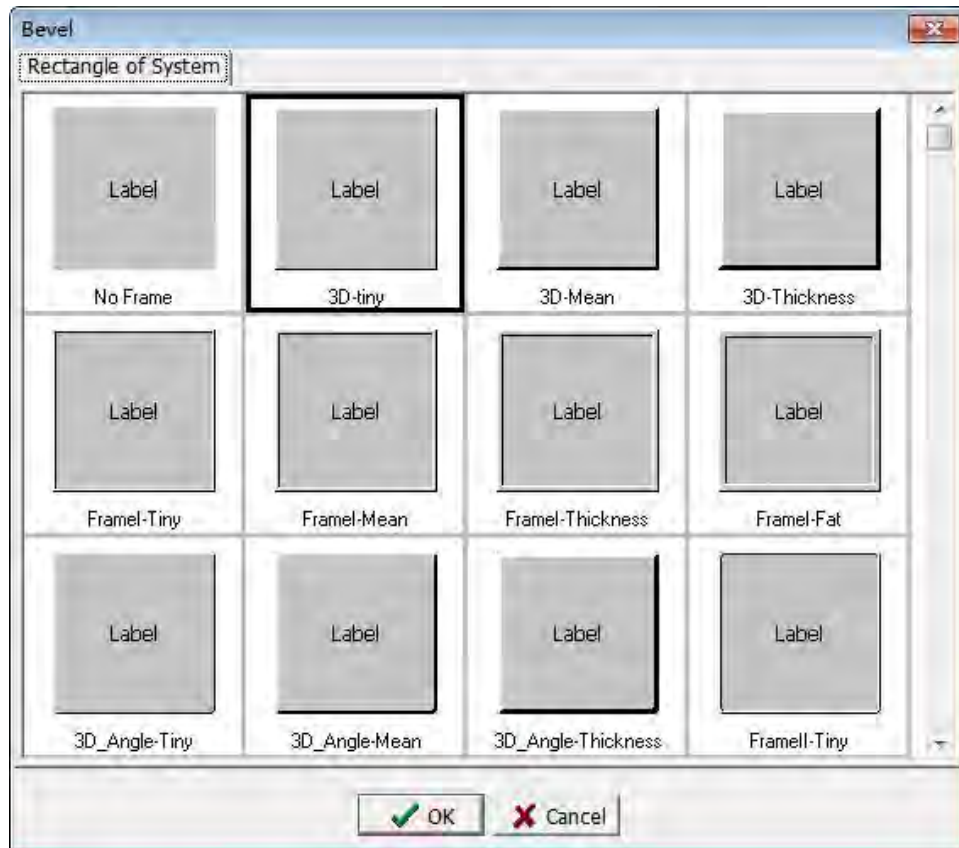

**Out color:** select the color of the frame of the component.

**In color:** select the inner frame color of the component.

### Brush

Style: Select the brush style of the component, refer to 3.1.1 for details.

### Position

X: Set the X coordinate position of the element.

Y: Set the Y coordinate position of the element.

W: Set the width of the element.

H: Set the height of the element.

### Text

Language: Select the language to be used by the component.

Color: Select the text color of the component.

Word Wrap: Check this option. When the length is insufficient, the text will automatically wrap. Otherwise, no line feed processing will be performed.

Align: Select the text alignment position of this component.

Effect: Select whether the text is displayed as normal or move.

Flash: Select whether the text is displayed normally or blinked.

Font: Select the font of the text. A dialog box for selecting specific font properties is displayed as shown in the figure below.

Text: Enter the text to be displayed. This component supports the display function of the embedded numeric value of the character string. For detailed

settings, please refer to Appendix 6 for the display function of the embedded numerical value of the character string.

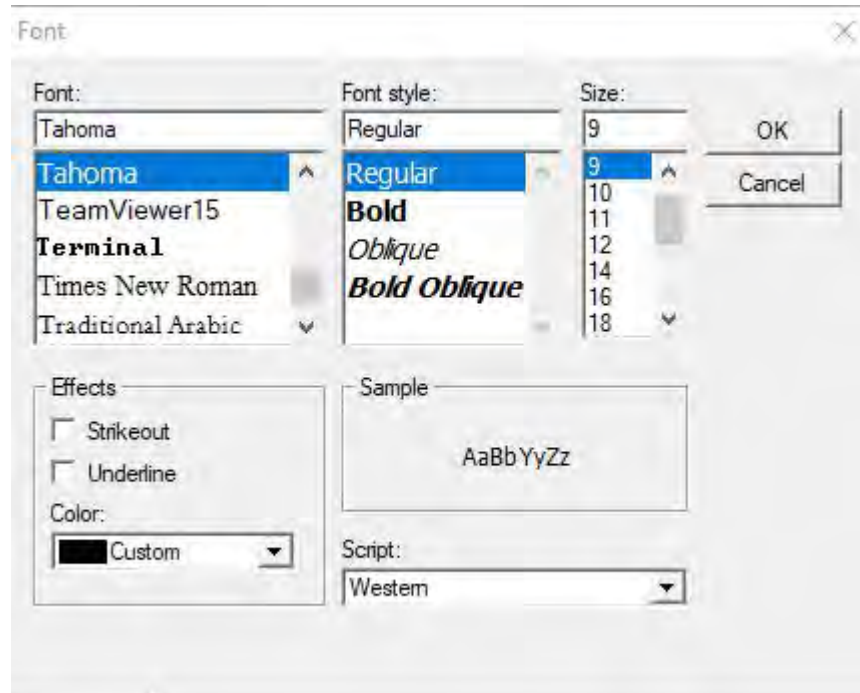

Font: Select the font style of the text.

Font style: Select the font style of the text.

Size: Select the font size of the text.

Effect-Strikeout: Select whether the text needs to be displayed with  
strikeout.

Effect-Underline: Select whether the text needs to be underlined.

Effect-Color: Select the color of the text display.

Sample: Display the effect of the selected text style.

Script: Select the language range when entering characters.

### 3.2.2 Scale

The property dialog box of the scale component is shown in the figure below. Since the [Bevel] setting is the same as that in Section 3.2.1, there is not much to repeat here, please refer to the [Bevel] setting in Section 3.2.1.



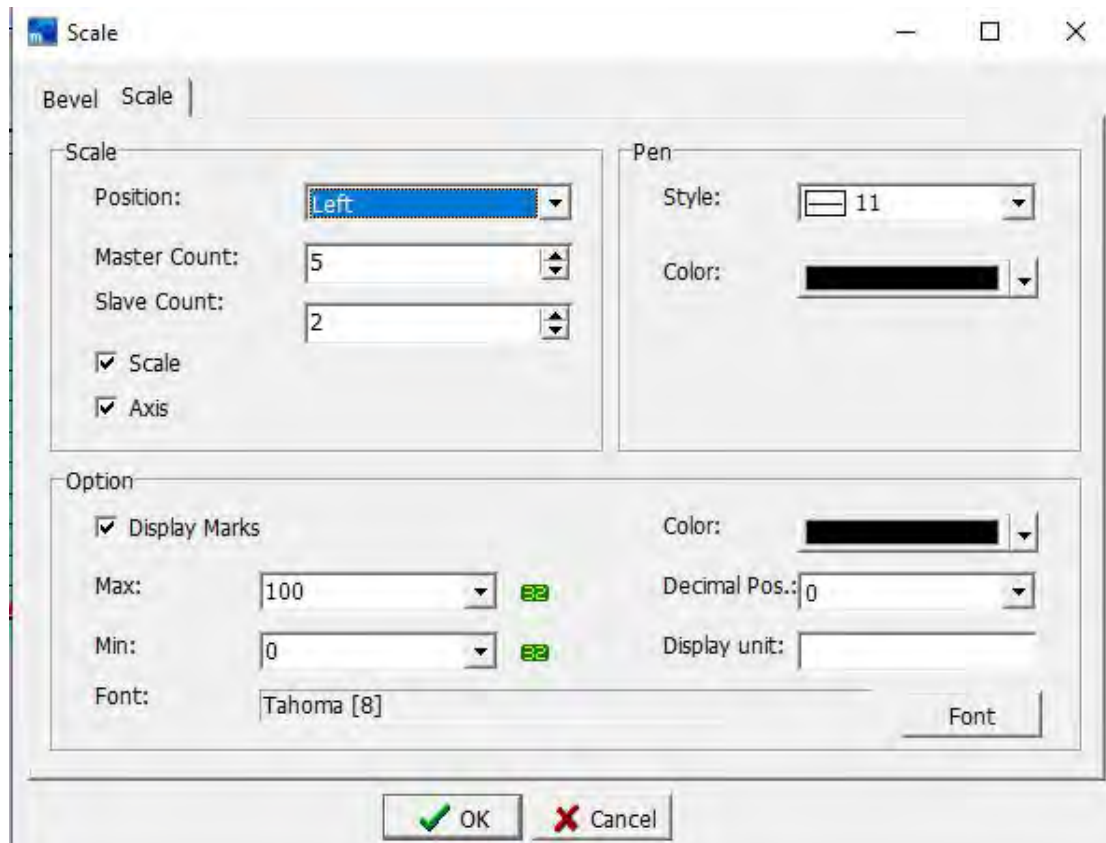

### Scale

**Position:** Select the scale direction.

**Master Count:** select the main scale number, including the top and bottom scale.

**Slave Count:** select the minor scale number, the small scale in the main scale.

**Scale:** Check “scale”, the scale will be displayed when editing the screen, and it will not be displayed if it is not checked.

**Axis:** Check “axis”, the coordinate axis will be displayed under the scale of the editing screen, and if it is not checked, it will not be displayed.

### Pen

**Style:** Select the scale style.

**Color:** Select the color of the scale style.

### Option

**Display Marks:** Check the display marks, and the scale will display the value of the large scale, subject to the maximum and minimum settings.

**Max:** Set the maximum value on the scale.

**Min:** Set the minimum value on the scale.

**Color:** Set the display color.

**Decimal Pos. :** Set the number of decimals in the display mark.

**Suffix:** Set the display unit of the display mark, which can be left blank.

Font: Set the font of the display mark. For detailed settings, please refer to the font setting in 3.2.1.

### 3.2.3 Table

The property dialog box of the table component is shown below. Since the [Bevel] is the same as that in Section 3.2.1, there is not much to repeat here, please refer to the [Bevel] setting in Section 3.2.1

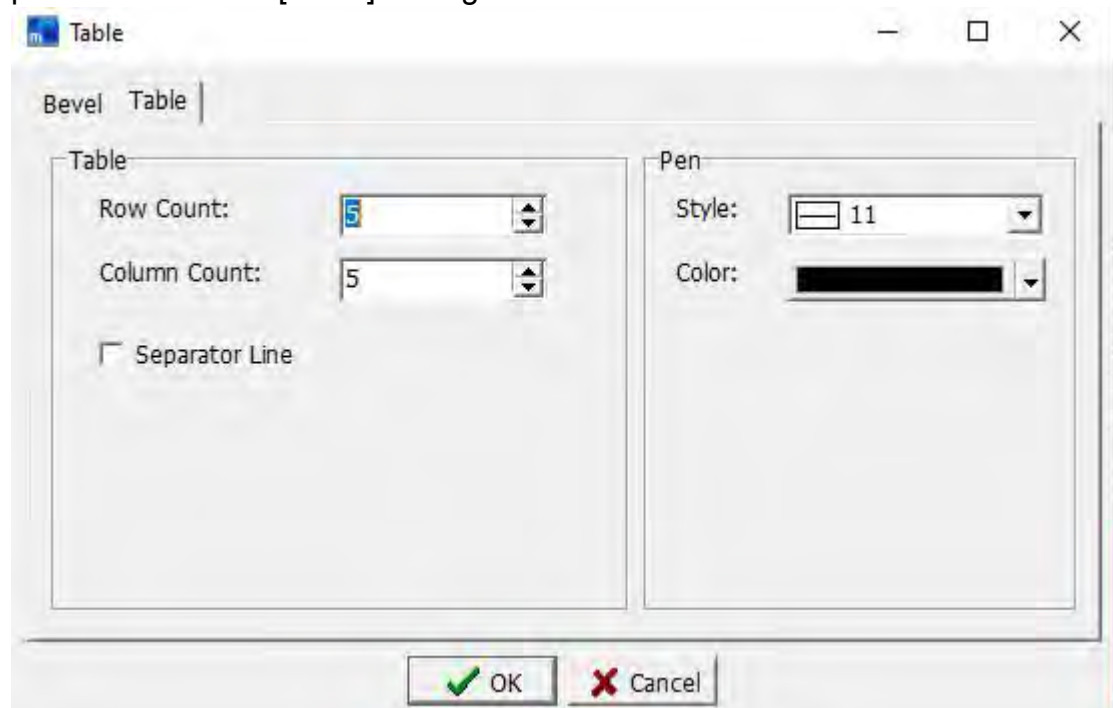

#### Table

Row Count: Select the number of lines in the horizontal grid.

Column Count: Select the number of lines in the vertical grid.

Separator Line: Check the separator line, a diagonal line will be generated in the upper left corner of the field, as shown in the blue circled part below.

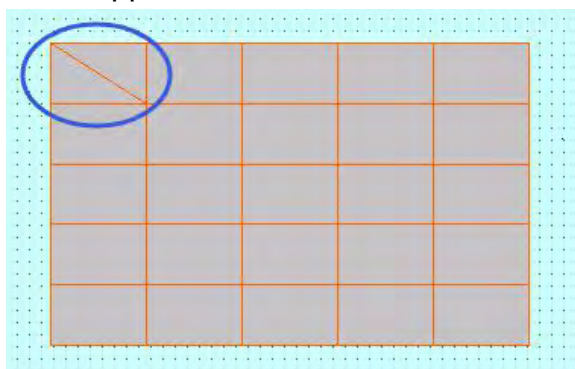

#### Pen

Style: Select the line style of the table component.

Color: Select the line color of table components.

### 3.2.4 Picture

The property dialog box of the picture component is shown below. Since the [Bevel] setting is the same as that in Section 3.2.1, there is not much to repeat here, please refer to the [Bevel] setting in Section 3.2.1.

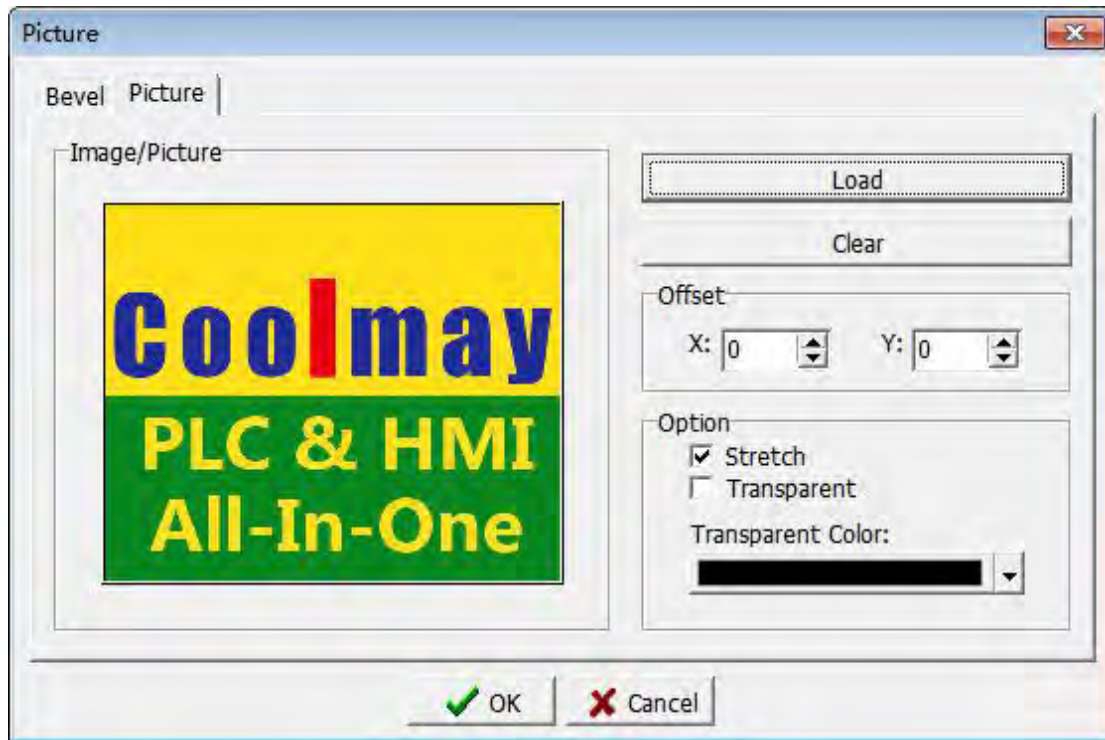

#### Image / Picture

Display the display effect after loading the graphics.

**Load:** Click this button to pop up the dialog box, select the graphic or animation pattern to be loaded.

Available formats: png, gif, jpg, jpeg, bmp, ico, emf, wmf.

**Clear:** Click this button to clear the previously selected graphic.

#### Offset

**X:** Use the center point of the picture element as the base point to shift left and right in the X direction.

**Y:** Use the center point of the picture element as the base point to shift up and down in the Y direction.

#### Option

**Stretch:** Tick stretch and the graphics will be automatically scaled according to the window size.

**Transparent:** Tick transparent to make the selected graphics appear transparent.

**Transparent Color:** Select the color that needs to be transparent.

### 3.2.5 Memo

For details of attribute setting, please refer to chapter 3.2.1 Static Bevel/Text.

## 3.3 Button

To use the button component, you can click [Button] under the [Component] menu bar, and the drop-down option of the button component appears, as shown in the following figure 3.3-1, or you can directly click the option on the tool shortcut bar, as shown in the following figure 3.3-2.

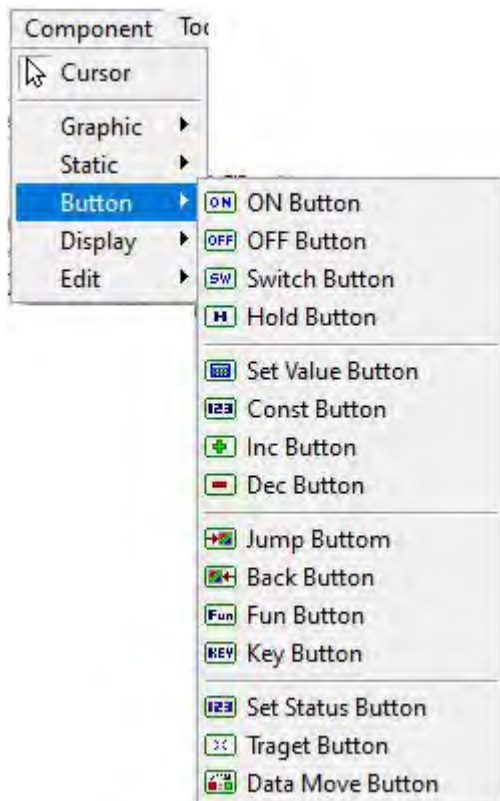

3.3-1



3.3-2

### 3.3.1 ON/ OFF Button and Switch/ Hold Button

After selecting the component, right-click the component to select the component properties, or double-click the component to open the component properties dialog box. The property dialog box of the ON/ OFF button and Switch/ Hold button components is shown below.

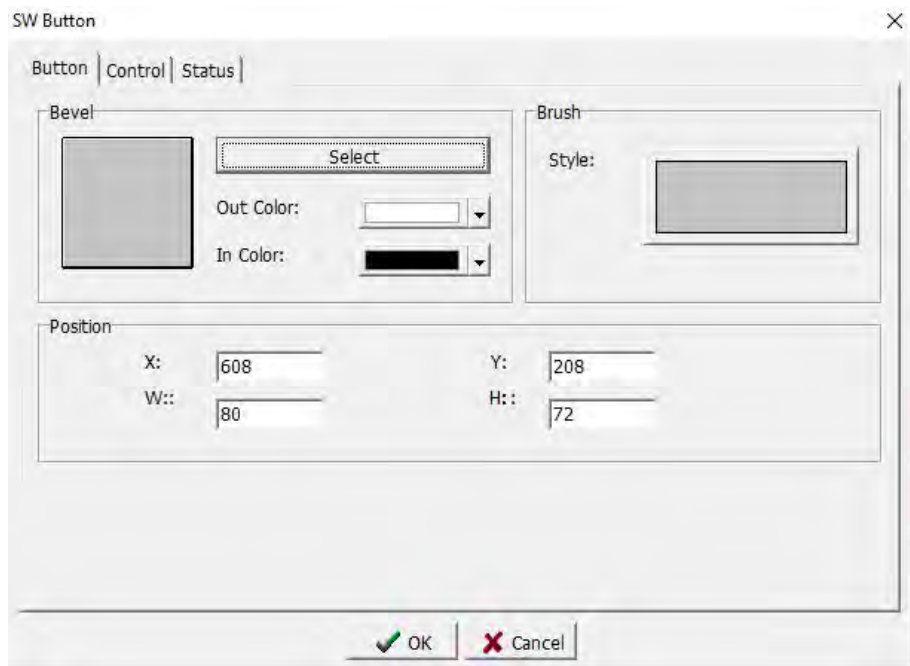

## 1. Button

As the properties of the [Button] page are the same as the [Bevel] settings in Section 3.2.1, there is no need to repeat here. Please refer to the [Bevel] settings in Section 3.2.1.

## 2. Control

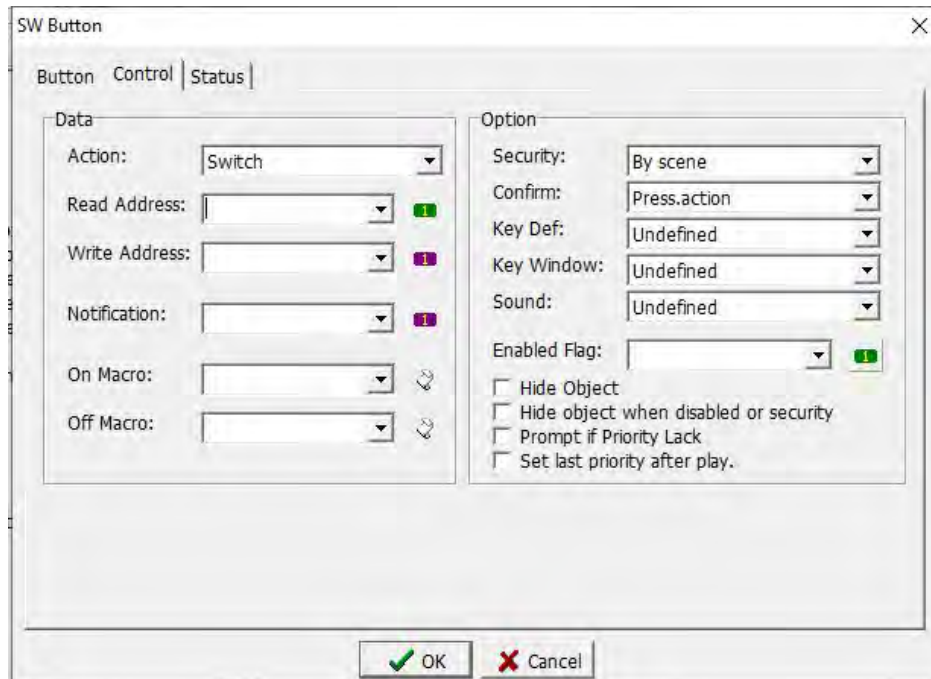

**Action:** There are four actions to choose from, and you can choose the state the button action.

**Read Address:** Read the value of the position of input relay or system variable.



**1**: Represents the reading position, and the type is bit.

Write Address: Write the value to this location of the input relay or system variable.

**1**: Represents the writing position, and the type is bit.

Notification: If a value is written to the position of the input relay or system variable, the position will be notified.

On Macro: Click the drop-down arrow to select the macro command edited in advance, and execute the selected macro command when the button is ON.

Off Macro: Click the drop-down arrow to select the macro command edited in advance, and execute the selected macro command when the button is OFF.

### Option

Security: Since you have the authority to set the screen when creating a new screen, please refer to Section 2.4.1 Screen. If the authority set here is higher than the screen authority, the account and password will be required to enter when the button component is run on the emulation or human-machine interface.

Confirm: Release. action: Run the action when the button component is released.

Wait Sec: Set waiting time in order to avoid accidentally pressing. When press the button, you will wait for the time as set here before running the component action.

Press. action: Run the action when the button element is pressed.

Key Def: After setting the keyboard definition in Section 2-4.5, you can select the function you need.

Key Window: This function is only available when the screen properties have dialog box properties. Press the button, the selected dialog box window will appear. If this function is operated, a dialog box window will appear to determine whether to run a certain function.

Sound: Set the sound when the button is clicked.

Enabled Flag: Set the condition variable. If set variable as 1, the button can perform the corresponding action, otherwise the button does not act.

Hide Object: Check this option to hide the component.

Hide Object when disabled or security: Check this option, the component will be hidden when the authority is not reached, or the controlled conditions are not met.

Prompt if Priority Lack: Check this option, when the permission is insufficient, the component will display a prompt symbol (small lock) to indicate that it cannot be operated. The lock will not be canceled until the permission is sufficient.

Set Last Priority after Play: After the action, set the last priority. Check this option, click the button, after the action is completed, modify the [Option]-> [Security] – “Use Level 9 (Low)”.

### 3. Status

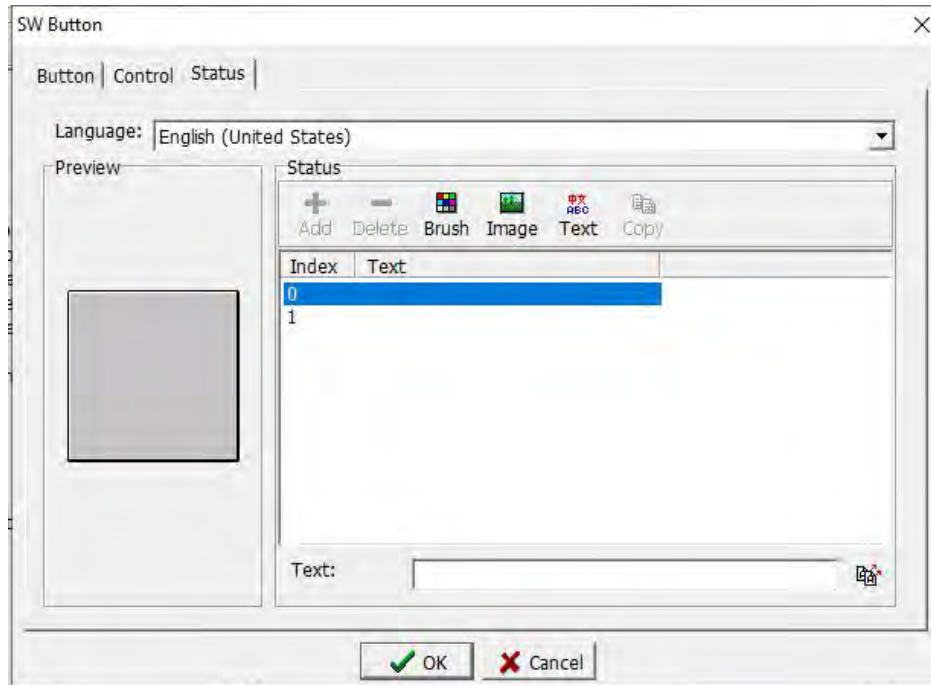

Language: Select the current language. For details, please refer to Section Chapter 5 Language Management.

Preview: You can see the input text preview here to prevent input errors.

#### Status

Add: Since there is only 0 or 1 status, there is no new function here.

Delete: Since there is only 0 or 1 status, there is no new function here.

Brush: For specific settings, please refer to 3.1.1.

Image: For specific settings, please refer to 3.2.4.

Text: For specific settings, please refer to 3.2.1.

Copy: Since there is only 0 or 1 status, there is no new function here.

Index | Text: Index 0 is the text displayed when the button is pressed, and index 1 is the text displayed when the button is not pressed.

Text: Input text to be displayed here.



: Click this button to copy current text to all status.

#### 3.3.2 Set Value/ Const Button and Inc/ Dec Button

After selecting the component, right-click the component to select the component properties, or double-click the component to open the component properties dialog box.

## 1. Button

As shown in the figure below, the properties of the [Button] page are the same as the [Bevel] settings in Section 3.2.1, please refer to the [Bevel] settings in Section 3.2.1.

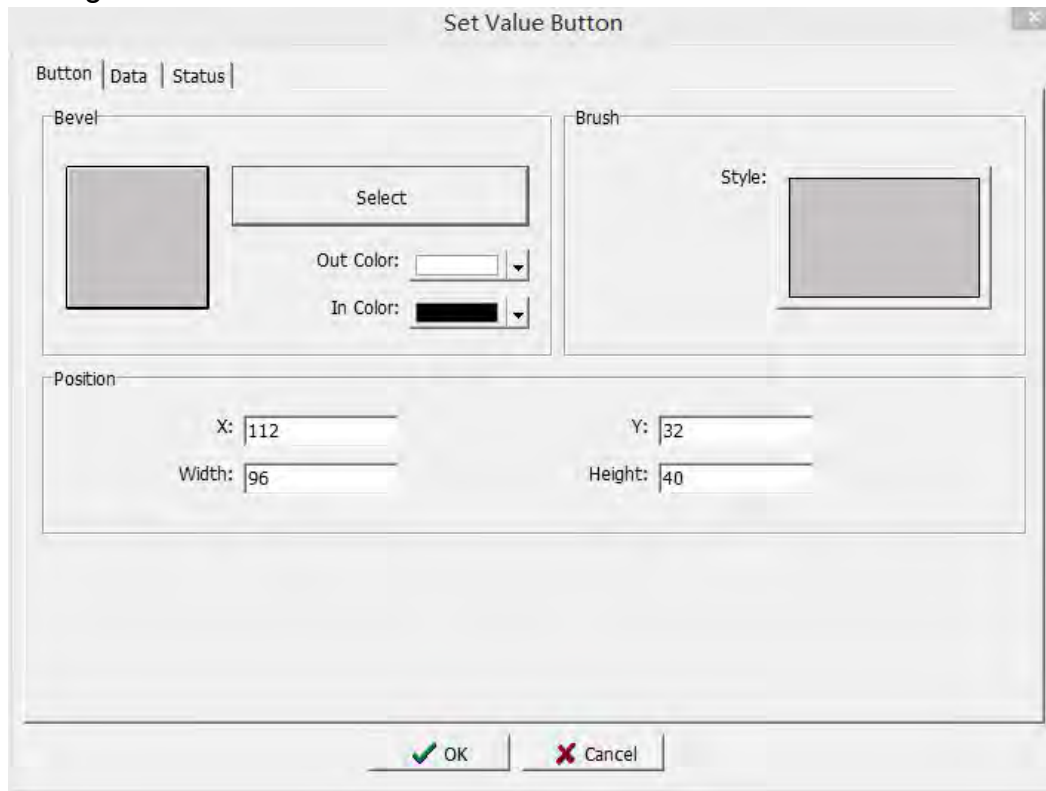

## 2. Control

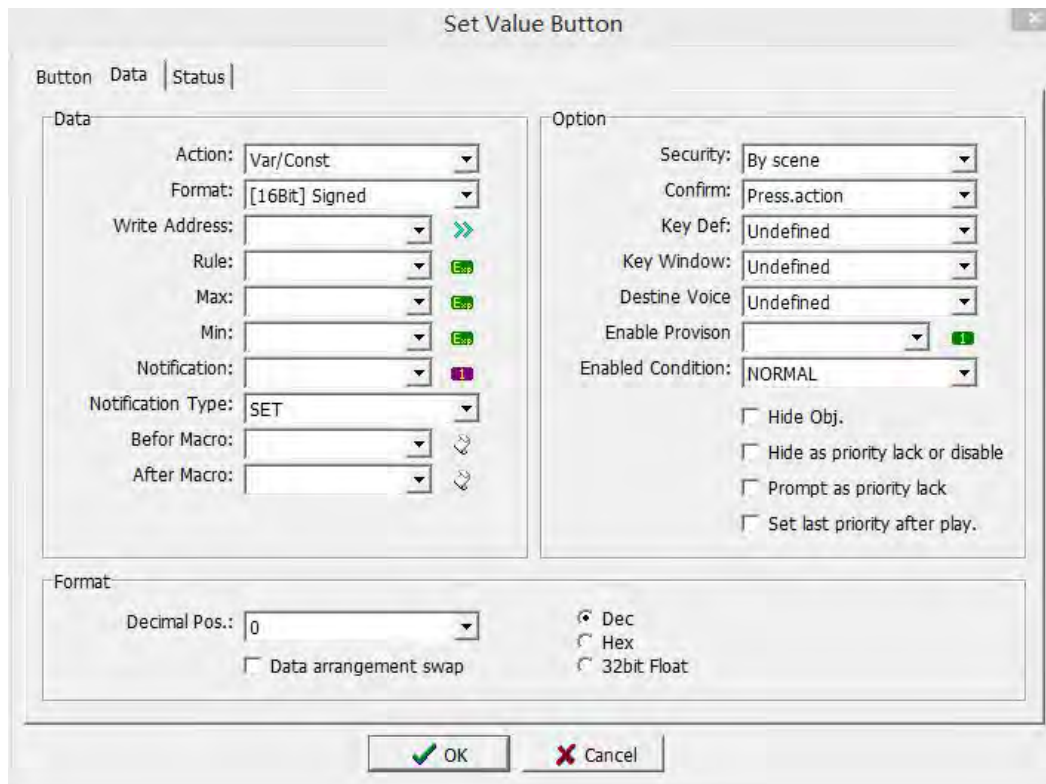

## Data

Action:

Input: Used in conjunction with the keyboard window, input data from the screen to the contact variable position.

Var/Const: Select this option, the value to be input to the contact variable can be input by the writing rule.

Inc/Dec: Select this option, and click the button once to add or subtract the data set in the rule once to the contact variable.

Format: Select the data format to be written.

Write Address: Enter the position of the contact variable to be written.

Rule: Set the calculation method of the written data or variables.

When the action selection is variable / constant, directly input the value to the contact variable.

When the action selection is Inc/ Dec, if the value is increasing, the symbol [+] should be added in front of the value, and if the value is decreasing, the symbol [-] should be added before the value.

: This icon is the identifier of the arithmetic element variable, indicating that the calculation between variables is supported here. For example: N100 + N200 are filled here, when writing data, the system will calculate the result of N100 + N200 and write it in. For details, please refer to Appendix 4 Instructions for Using Operation Variables.

Max: The maximum value of the reading range of the input position.

Min: The minimum value of the reading range of the input position.

The maximum and minimum value can be not input. When not input, the value range refers to the set data type.

Notification: The input relay or system variable position will be notified when a value is written to the position.

Notification Type: Used in conjunction with write notification, you can choose to write 1 or write 0. If the write notification is set to [M0] and the write notification mode is [write 1], if a value is written to the write location, M0=1.

Before Macro: Enter the name of the edited macro directly or click the drop-down arrow to select an existing macro. The macro is triggered when the button is pressed.

After Macro: Enter the name of the edited macro directly or click the drop-down arrow to select an existing macro. The button will trigger when the macro pops up.

## Option

Please refer to option instructions in 3.3.1.

## Format

Decimal Pos.: Set the number of decimal places.

Data arrangement swap: high and low bytes swap. 16 bit: high and low BYTE swap; 32 bit: high and low WORD swap.

Dec: Check this option to display as a decimal value.

Hex: Check this option to display it as a hexadecimal value.

32bit Float: Check this option to display 32-bit floating point values.

### 3. Status

For details, please refer to the status instructions in 3.3.1.

#### 3.3.3 Jump/ Back Button

After selecting the component, right-click it to select the component properties, or double-click it to open the component properties dialog box.

#### 1. Push Button

Please refer to the [Bevel] settings in Section 3.2.1.

#### 2. Control

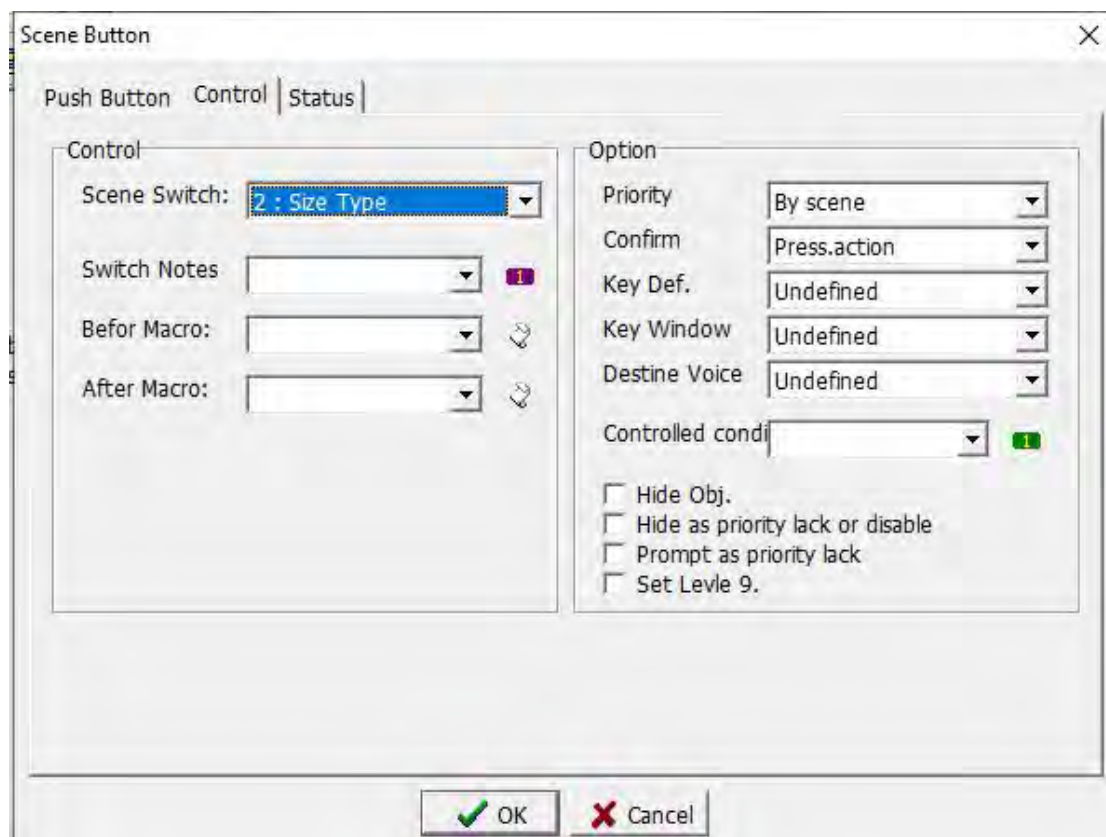

#### Control

Scene Switch: When there are multiple screens in the project, this function can be used to switch screens, and we can choose which screen to jump to or return to.



Switch Notes: Set the notification action when the screen is switched, i.e. you can set a certain register to be turned on or off when the screen is switched.

Before Macro: Enter the name of the edited macro directly or click the drop-down arrow to select an existing macro. The macro is triggered when the button is pressed.

After Macro: Enter the name of the edited macro directly or click the drop-down arrow to select an existing macro. The button will trigger when the macro pops up.

Option: Please refer to option instructions in 3.3.1.

### 3. Status

For details, please refer to status instructions in 3.3.1.

#### 3.3.4 Fun Button

The details of the function button property settings, please refer to chapter 3.3.1. This section only explains the different settings.

Action:

Set to last priority: Select it to set the screen attribute authority to the minimum.

Inputs password again: Select it to input password again.

Clear all alarm event: Select it to delete all alarm events.

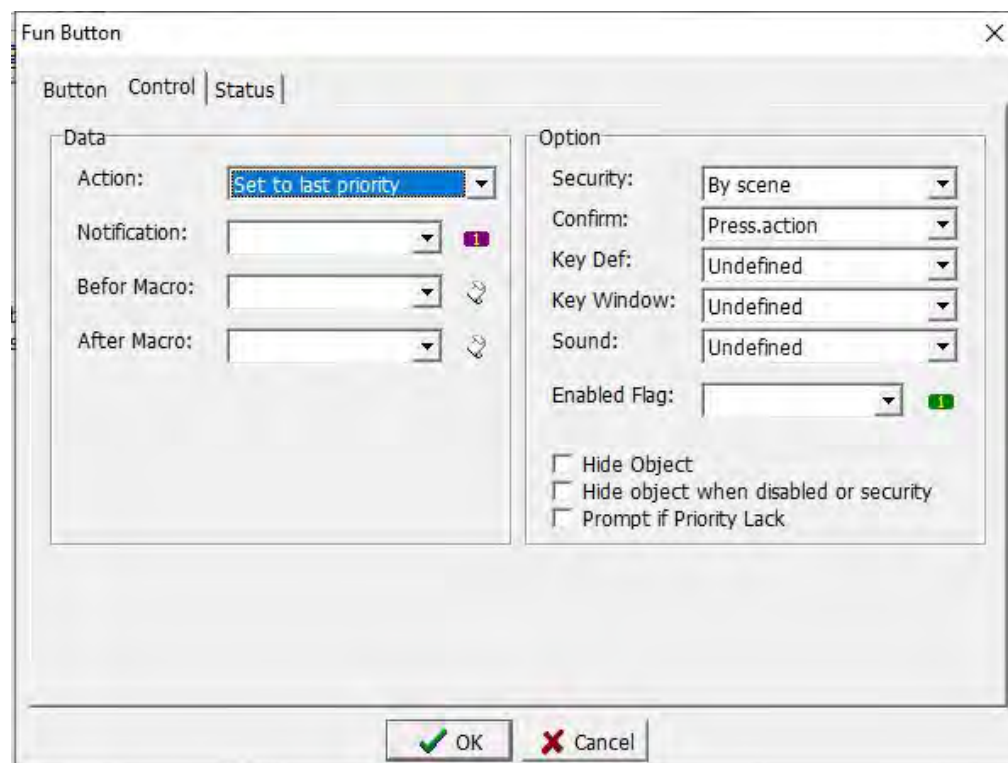

### 3.3.5 Key Button

The detailed instructions of Button and Status, please refer to chapter 3.3.1. This section only explains the different settings.

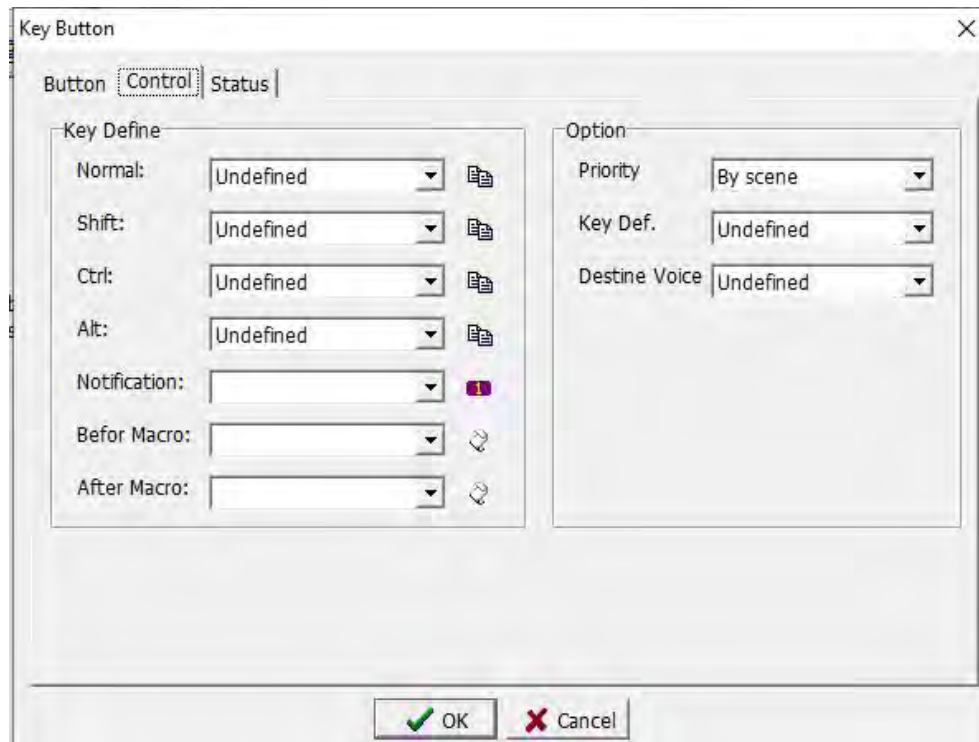

Normal: The action to be performed when the button is pressed.

: Click this icon to copy the function set by the current button to the other three buttons.

Shift: The action to be performed when you press the [Shift] key and then press the button.

Ctrl: The action to be performed when you press the [Ctrl] key and then press the button.

Alt: The action to be performed when the [Alt] key and then the button is pressed.

Notification: Click the button and write 1 into the set position.

Before Macro: Enter the name of the edited macro directly or click the drop-down arrow to select an existing macro. The macro is triggered when the button is pressed.

After Macro: directly enter the name of the edited macro or click the drop-down arrow to select an existing macro. The macro is triggered after the button pops up

Key Def.: It can be used when the man-machine model supports keyboard keys.

The Shift, Ctrl, and Alt keys here refer to those that set with the key buttons, not those of the computer keyboard. As shown in the following figure, the Shift key is used as an example, and this button will be used as the functions of shift.

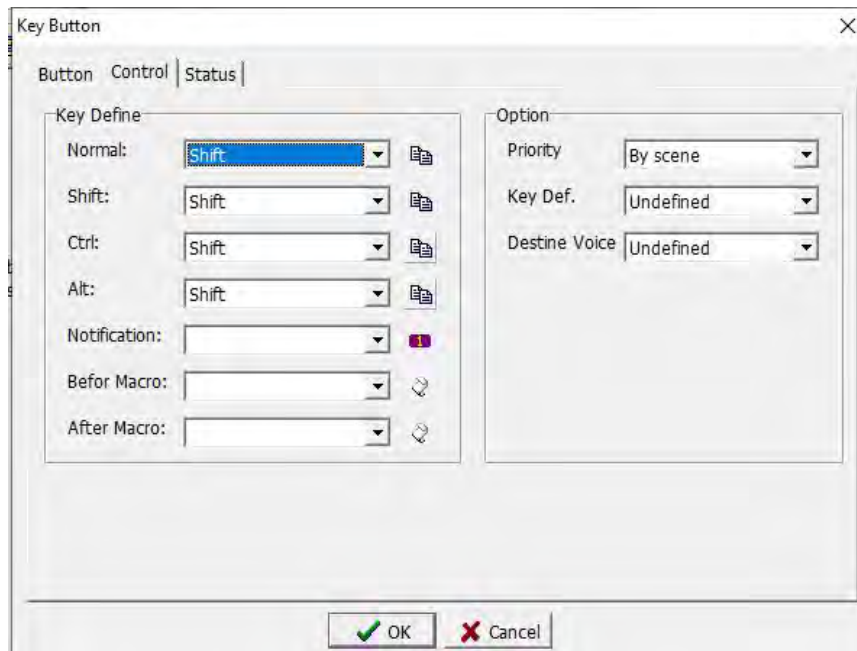

In the status, all the texts are typed into shift since this button is only used as a shift function and has no other functions. If it contains other functions, please set according to the function name.

As shown in the figure below, the index value is 0 ~ 3, which means that the normal key is 0, Shift is 1, Ctrl is 2, and the Alt state is 3, so if we want a key button to have many functions, we can set the functions according to it.

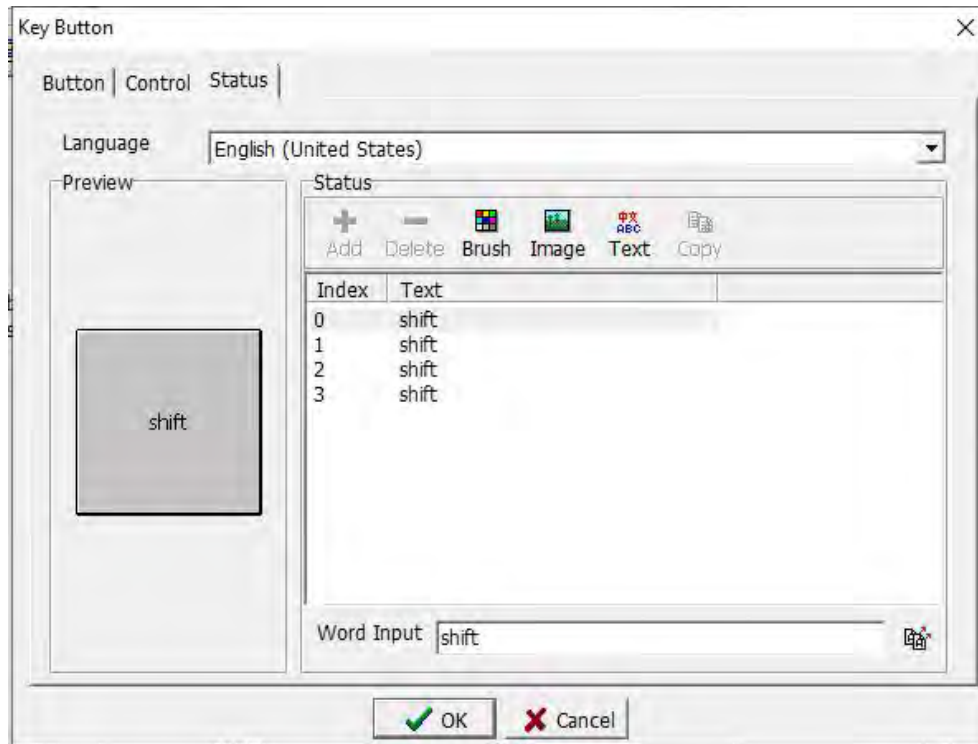

The setting of the shift key is completed as shown above. When the button is pressed in the screen, it means that the shift key is pressed, so that the above-mentioned Shift, Ctrl, Alt state can be used accordingly.

### 3.3.6 Set Status Button

The detailed instructions of Button and Status, please refer to chapter 3.3.1. This section only explains the different settings.

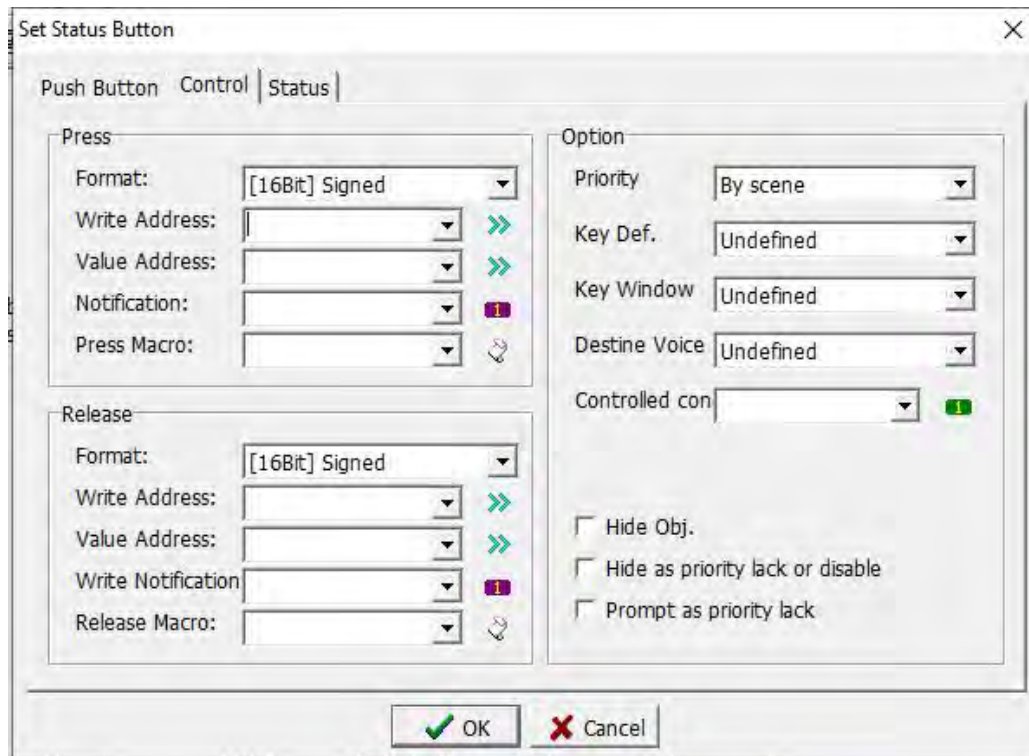

### Control

**Format:** Set the format of the register variable.

**Write Address:** Set the location to write data.

**Value Address:** Set the content that written in. For example, set it as D0, and the writing position as D1. When the action occurs, write the contents of D0 to D1.

**Notification:** When writing, set the variables set by the notification.

**Press Macro:** Enter the name of the edited macro directly or click the drop-down arrow to select an existing macro. The macro is triggered when the button is pressed.

**Release Macro:** Enter the name of the edited macro directly or click the drop-down arrow to select an existing macro. The macro is triggered after the button is released.

### 3.3.7 Target Button

The detailed instructions of Button and Status, please refer to chapter 3.3.1. This section only explains the different settings.



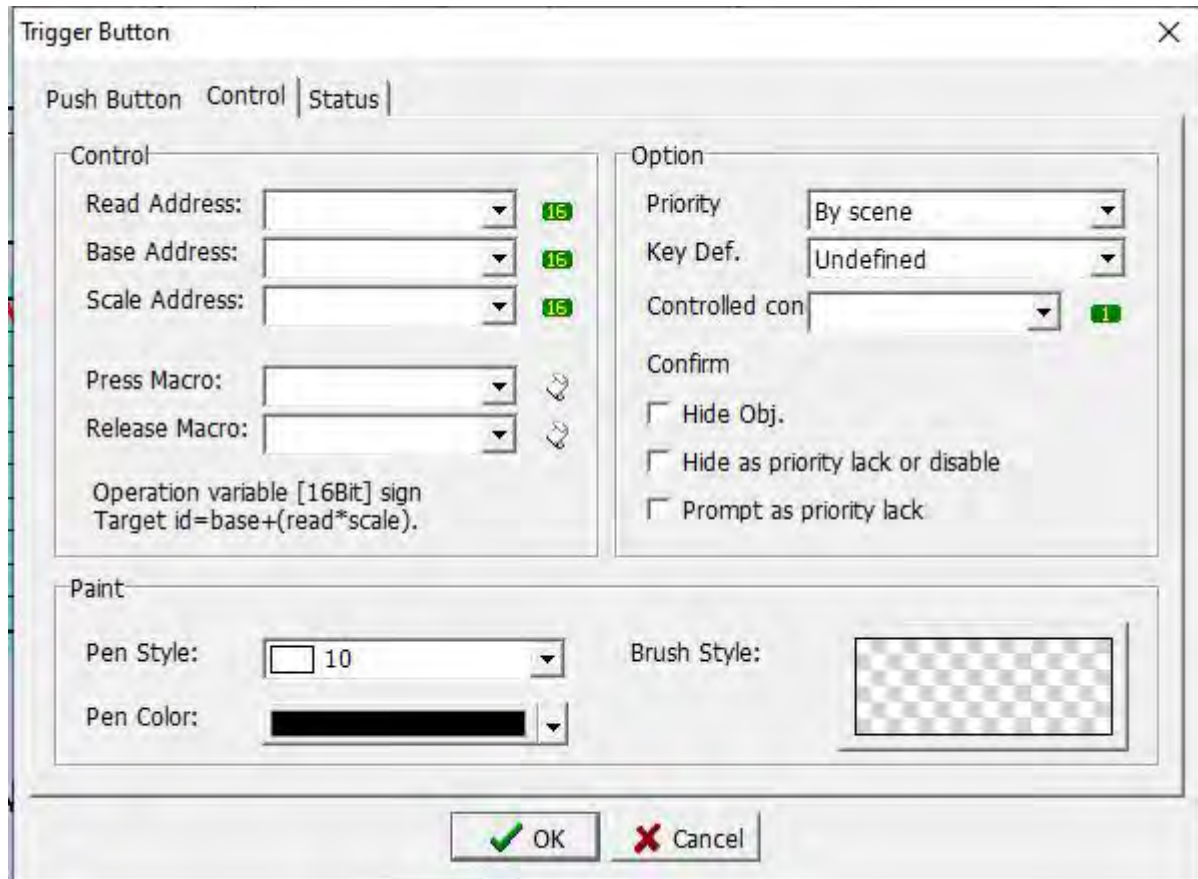

**Project making:** when there is a series of parameters to be set, in order to facilitate the settings and avoid misoperation to hit other settings, you can use the trigger button.

**Read Address:** Select a variable as the basis for switching the number of columns.

**Base Address:** Set according to the serial number of the first column of components, click [F4] to view the component serial number. For example, if the serial number of the first element of the parameter element needs to be set as 8 on this line, the cardinal position is selected as 8.

**Scale Address:** Set according to the number of rows of the group where the component is located. For example, if the row is the third row, set it to 3.

### 3.3.8 Data Move Button

The detailed instructions of Button and Status, please refer to chapter 3.3.1. This section only explains the different settings.

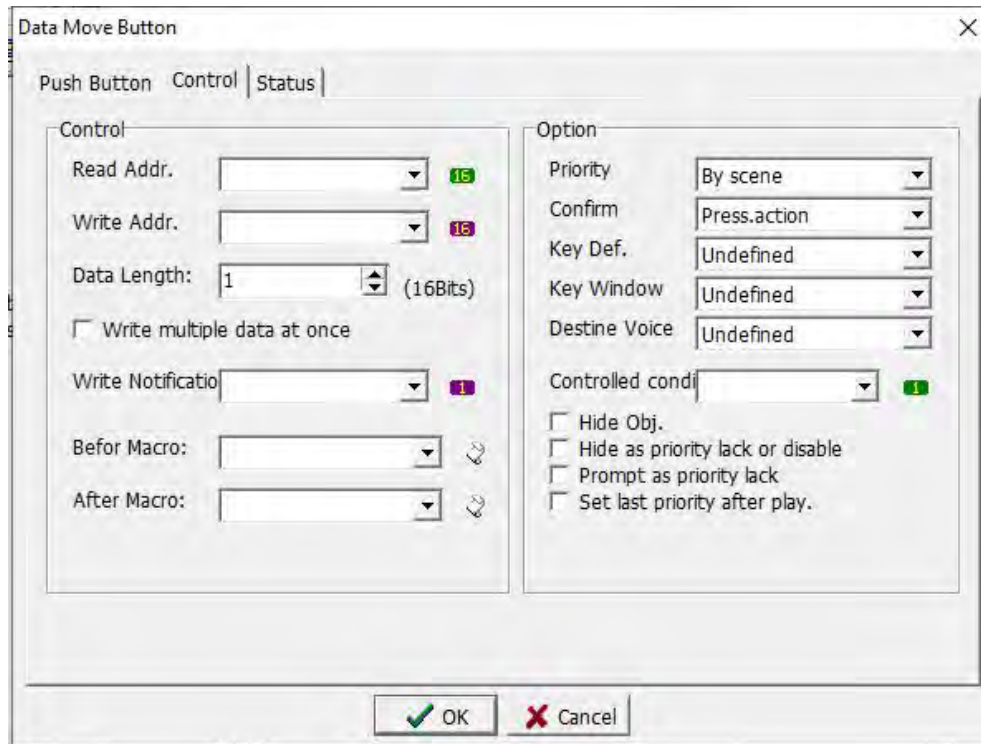

**Read Address:** Set the start position of the variable that needs to read data.

**Write Address:** Set the start position of the variable that needs to write data.

**Data Length:** Set the number of data to be read and written.

For example: As shown in the figure above, when you click the button, the values of 10 data in D0-D9 will be read and then written into 10 registers in D10-D19 respectively.

### 3.3.9 Numerical set ON/ OFF button and Alternate / Hold type button

After selecting the component, right-click in the component to select component properties, or double-click the component to open the component properties dialog box. The property dialog box of Numerical set ON / OFF button and Alternate/Hold button components is shown in the figure below.

**1.Button:** As shown in the figure below, since the page properties of [Button] are the same as the settings of [Bevel] in Section 3.2.1, there is no need to repeat the explanation here. Please refer to the [Border] settings in Section 3.2.1 for yourself.

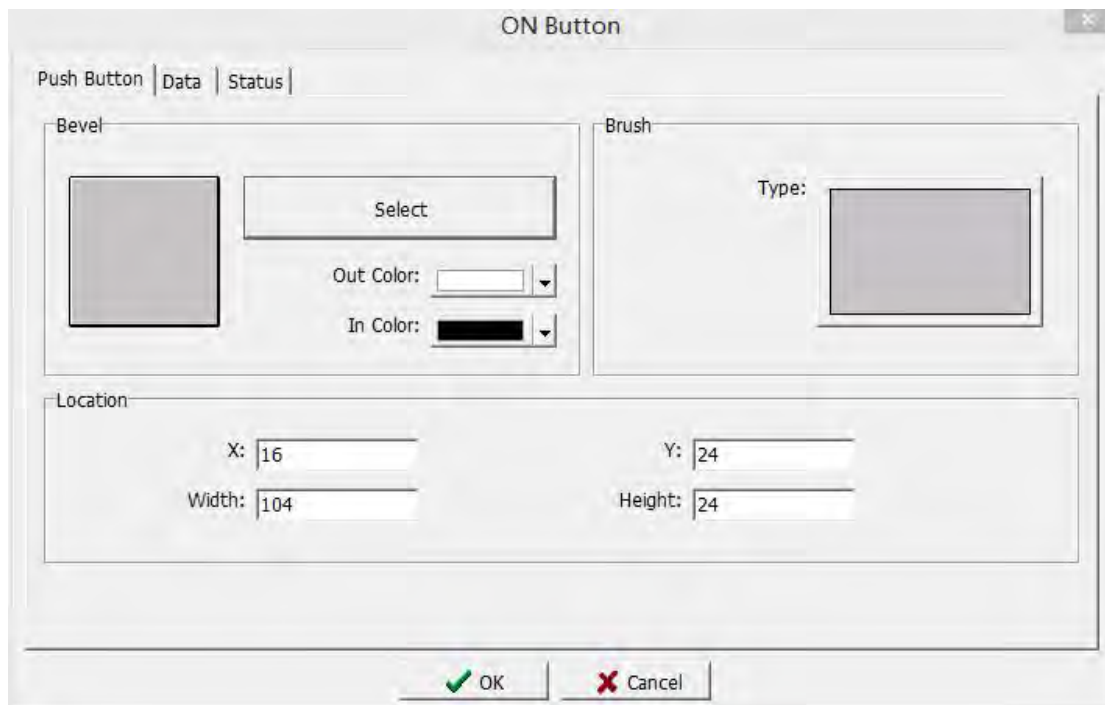

**2.Control:** as shown in the figure below.

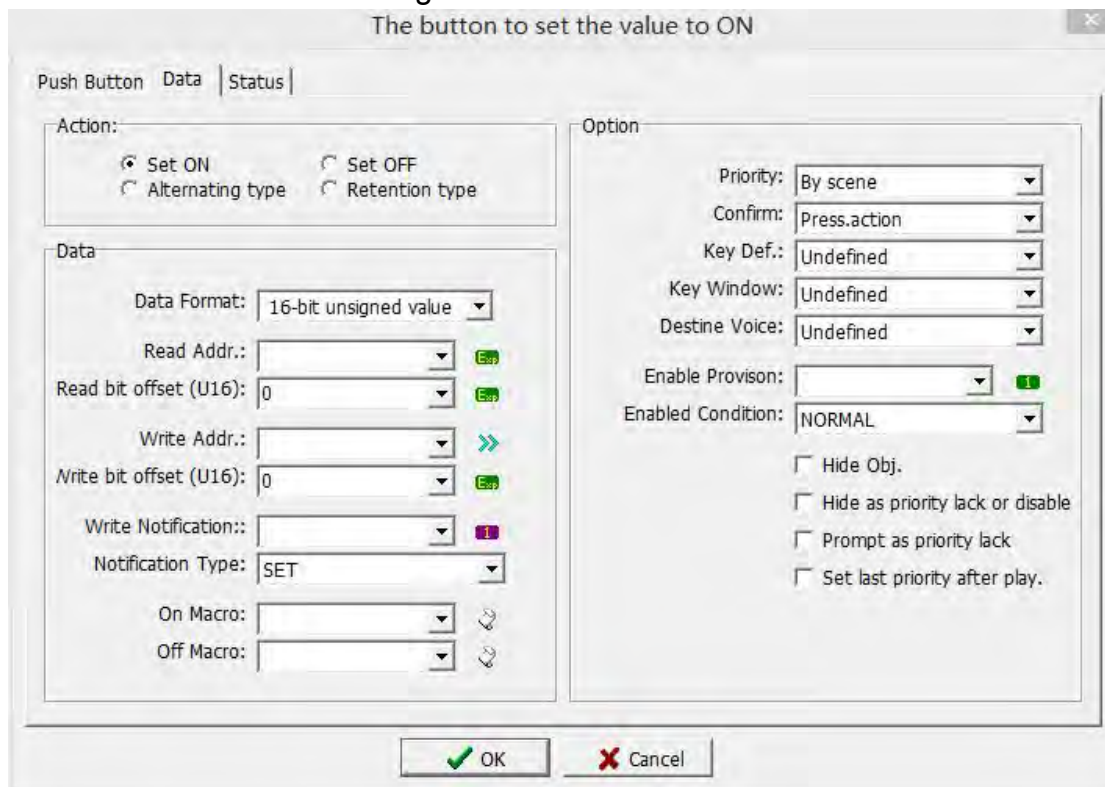

## Action

Action: There are four actions to choose from, you can choose which state the button action is.

## Control

Data Format: Select the type of data, there are two types: 16-bit unsigned and 32-bit unsigned.

Reading Addr.: The position of the input system variable.

Read bit offset (U16): Set the bit of the variable to be read; 0-15.

Write Addr.:The position of the input system variable.

Write bit offset (U16): Set the bit of the variable to be read; 0-15.

Write Notification: The input relay or system variable position, if a value is written to the writing position, the position will be notified.

Notification Type: Used in conjunction with write notification, you can choose to write 1 or write 0. If the write notification is set to [M0] and the write notification mode is [write 1], if a value is written to the write location, M0=1.

On Macro: Click the drop-down arrow to select the pre-edited macro command, and execute the selected macro command when the button is in the ON state.

Off Macro: Click the drop-down arrow to select the pre-edited macro command, and execute the selected macro command when the button is OFF

### Options

Priority: Because there is the authority to set up the screen when creating a new screen, please refer to section 2.4.1 Screen Management. If the authority set here is higher than that of the screen, when this button component is run on the emulation or HMI, it will be asked to enter the account password.

Use confirmation:

**Action when released:** Run action when the button element is released.

**Wait X seconds:** In order to prevent us from accidentally pressing it, so here is set to wait for the set time after pressing the button before running the component action.

**Action when pressed:** Run the action when the button element is pressed.

Keyboard Def.: After setting the keyboard definition in chapter 2.4.5, you can select which function you need to set before.

Keyboard Window: This function can only be used when the screen attribute has a dialog box attribute. When the key is pressed again, the selected dialog box window will be displayed. Generally, this function is used to display a dialog box window to determine whether to run a certain function.

Destine Voice: Set the sound to be emitted when the button is clicked.

Enable Provision: Set the condition variable. When the set variable is 1 or 0, the button can perform the corresponding action, otherwise the button will not operate.

Enable condition: Used in conjunction with controlled condition, when the variable can be set to 1 or 0, it is controlled. If the controlled condition is set to [M1], the controlled condition mode is [when the variable is 1, controlled]; when M1=1, the button can perform the corresponding action, otherwise the button will not work.

Hidden Obj.: Check this option, the component will be hidden.

Hide as priority lack or disable: Check this option, and the component will be hidden under the following conditions: when the permission is not met, or when the controlled condition is not met.

Prompt as priority lack: Check this option, when the authority is insufficient, the component will display a prompt symbol (small lock) to indicate that it cannot be operated, and the lock will not be cancelled until the authority is sufficient.

Set last priority after play.: Check this option, click the button, after the action is completed, modify the minimum operation authority of [Options] -> [Usage Authority].

**3.Status:** as shown in the figure below.

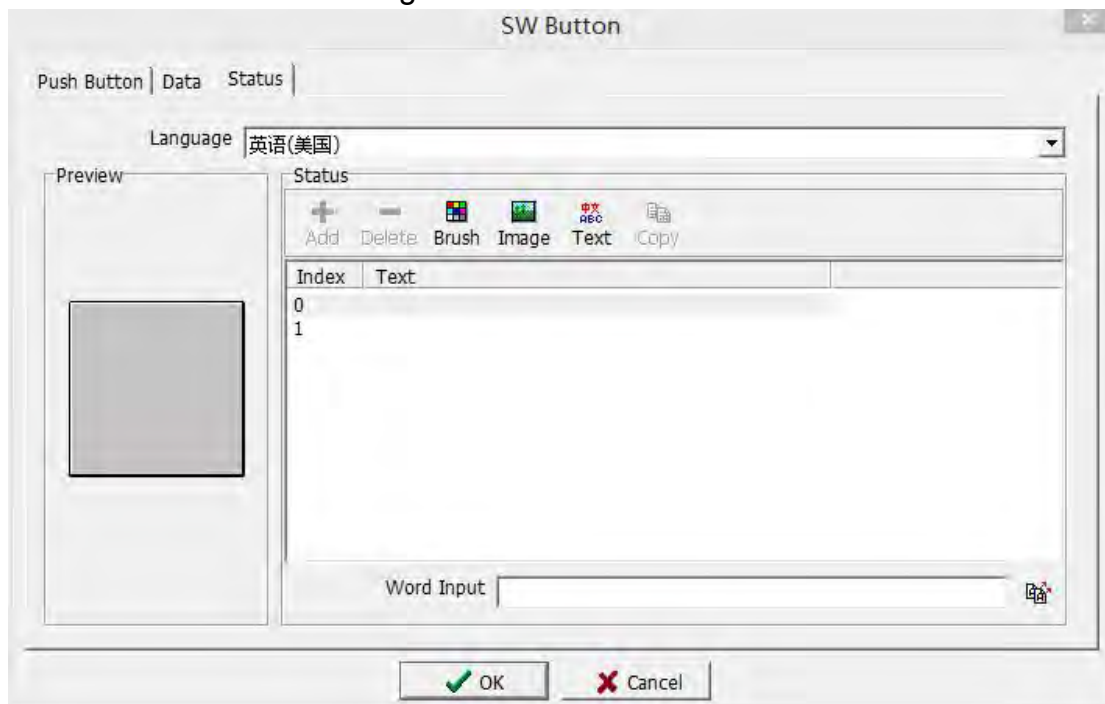

Language: Select the language currently in use. For details, please refer to Section 5 Language Management.

Preview: You can see the input text preview screen here to prevent input errors.

### Status

New: Since there is only 0 or 1, there is no new function here.

Delete: Since there is only 0 or 1, there is no delete function here.

Brush: Refer to section 3.1.1 for specific settings, and will not repeat the description.

Image: Refer to section 3.2.4 for specific settings, so the description will not be repeated.

Text: Please refer to section 3.2.1 for specific settings, and the description will not be repeated.

Copy: Since there is only 0 or 1, there is no copy function here.



Index/Text: Index 0 is the text displayed when the button is pressed, and index 1 is the text displayed when the button is not pressed Text.

Text input: Input the text to be displayed here。

: Click this button to copy the currently entered text to all states.

### 3.4 Display

To use the Status component, you can click [Status] under the [Component] menu bar, and the drop-down option of the status component appears, as shown in the following figure 3.4-1, or you can directly click this option on the tool shortcut bar, as shown in the following figure 3.4-2.

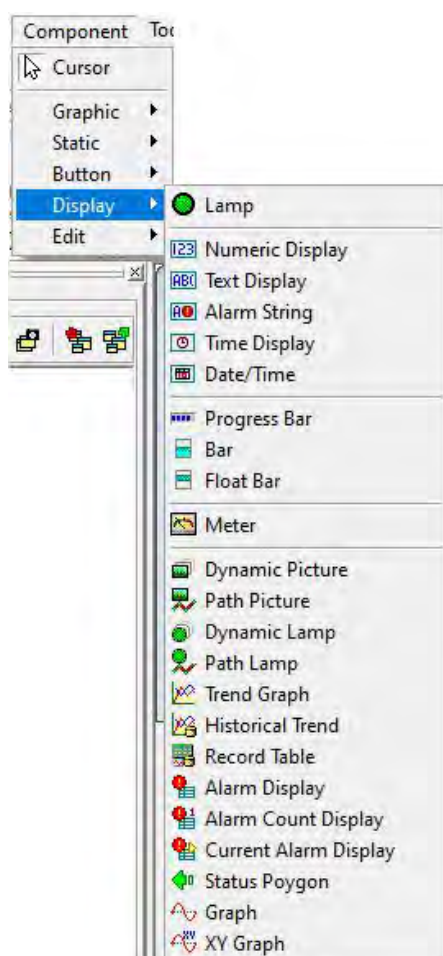

3.4-1



3.4-2

### 3.4.1 Lamp

The detailed instructions of Bevel, please refer to chapter 3.3.1. This section only explains the different settings of Control and Status.

#### 1. Control

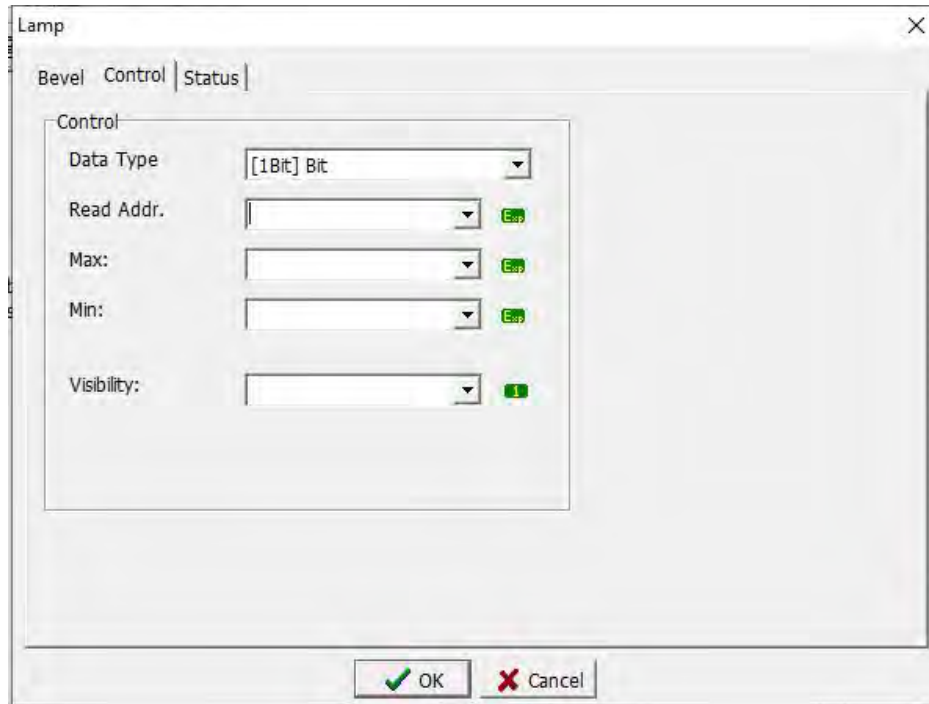

**Data Type:** Set the variable type or variable data format displayed by the lamp.

**Read Addr.:** Set the variable position displayed by the lamp.

**Max:** When read a register, the maximum value is the one you set. If not set value here, the value is decided by data format.

**Min:** When read a register, the minimum value is the one you set. If not set value here, the value is decided by data format.

**Visibility:** Set the variable position that makes this lamp show or hide.

#### 2. Status

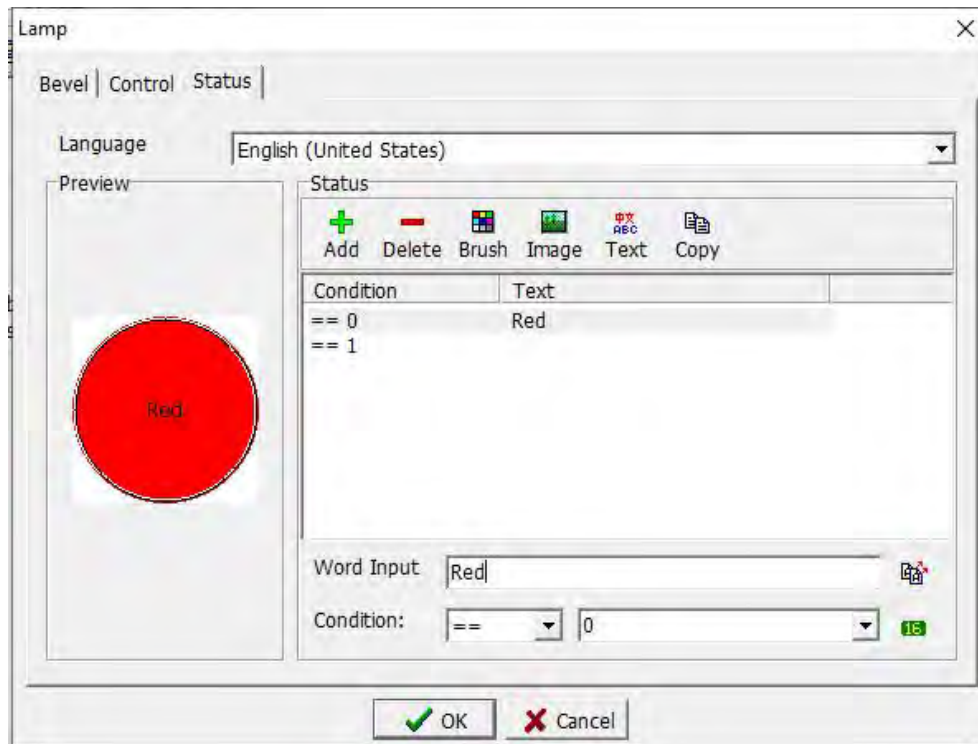

For details, please refer to the description of the status page in 3.3.1, only the differences are introduced here.

Add: Click this button to add a new condition.

Delete: Click this button to delete the selected condition.

Condition: Set the comparison condition of the selected condition. There are six types of comparison conditions: equal, not equal, less than, less than or equal, greater than, and greater than or equal to choose from.

 Connection / Para .: Enter the 16-bit register to compare with the register displayed by the lamp. According to the comparison results, the lamp shows different status.

### 3.4.2 Numeric Display

The detailed instructions of Bevel, please refer to chapter 3.3.1. This section only explains the different settings of Control and Text.

#### 1. Control

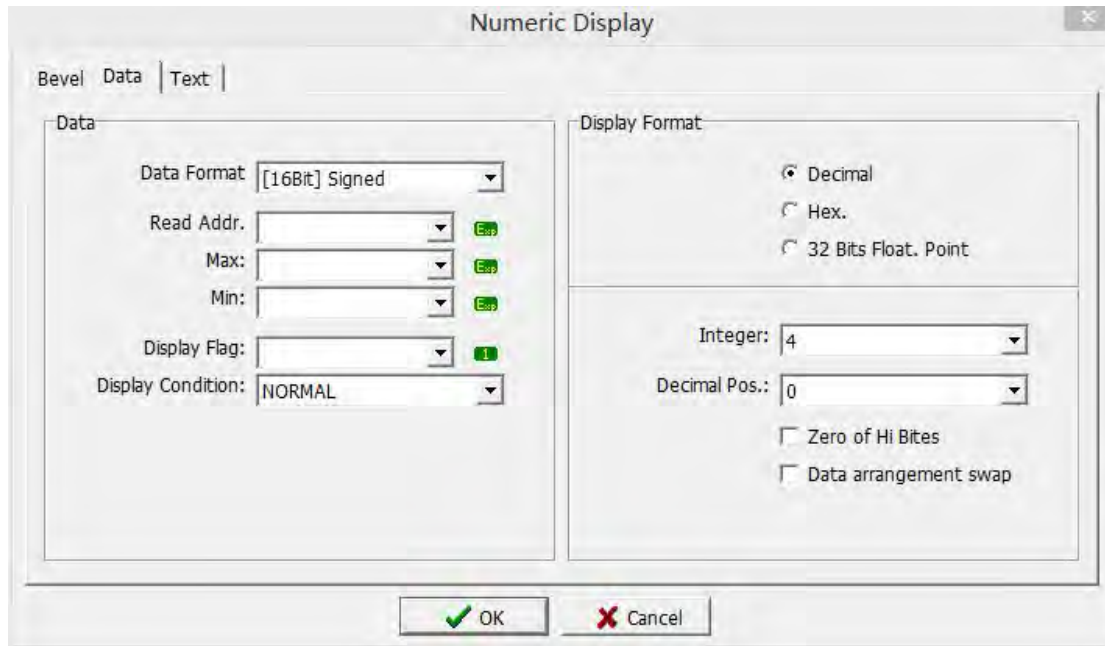

## Data

**Data Format:** Select the data format to be read.

**Read Addr.:** Set the variable address to be read.

**Max:** Set the maximum value of the variable to be read.

**Min:** Set the minimum value of the variable to be read.

**Display Flag:** Set the variable that makes the numerical display component show or hide.

**Display Condition:** Use with visibility, and display when the selectable variable is 1 or 0. If the visibility is set to [M0] and the display condition mode is [When the variable is 1, display], then when M0=1, the component is visible.

## Display Format

**Integer:** Set how many digits to display for integers.

**Decimal Pos. .:** Set how many digits to display for decimals.

**Zero of Hi Bites:** When the integer number is set to 4, the value will be filled with 0 to 4 digits if this option is checked.

**Decimal:** Select this option, the value is displayed in decimal form.

**Hex .:** Select this option to convert the displayed value to hexadecimal display.

**32 Bits Float. Point:** Select this option to display as a 32-bit floating point number.

**Data arrangement swap:** high and low bytes swap. 16 bit: high and low BYTE swap; 32 bit: high and low WORD swap.

## 2. Text

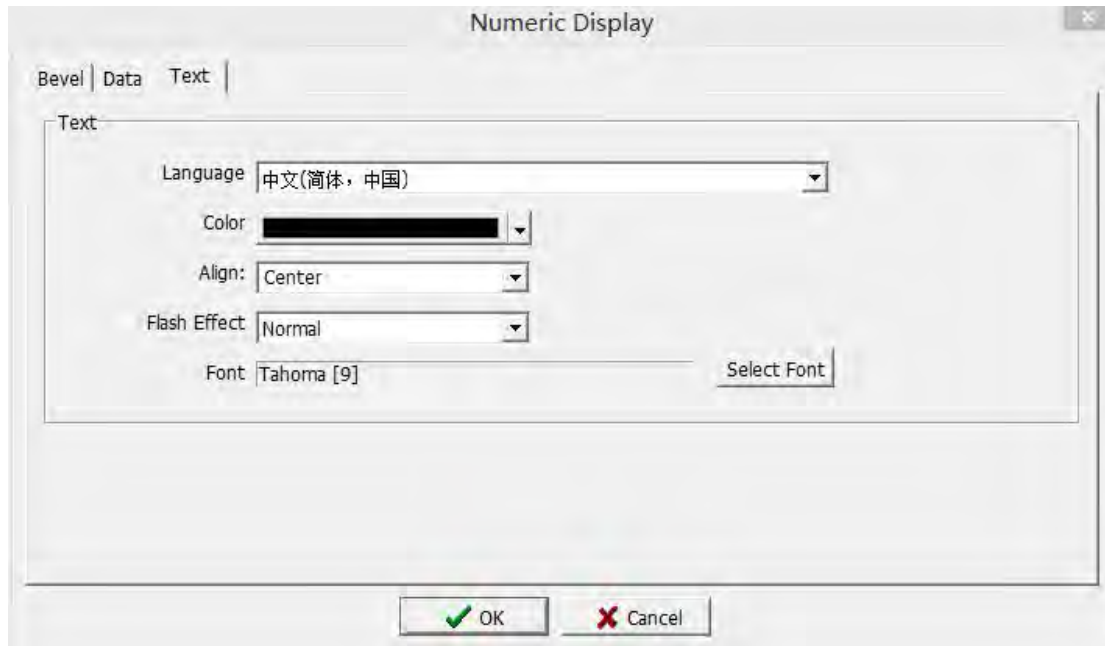

### Text

Language: Select the language type displayed.

Color: Select the color of the value displayed.

Align: Select the alignment of the numeric display when displaying.

Flash Effect: Select whether the value is normal or flashing during display.

Font: Set the font type and size of the value when displaying, please refer to 3.2.1 for details

### 3.4.3 Text Display

The detailed instructions of Bevel, please refer to chapter 3.3.1. This section only explains the different settings of Control and Text.

## 1. Control



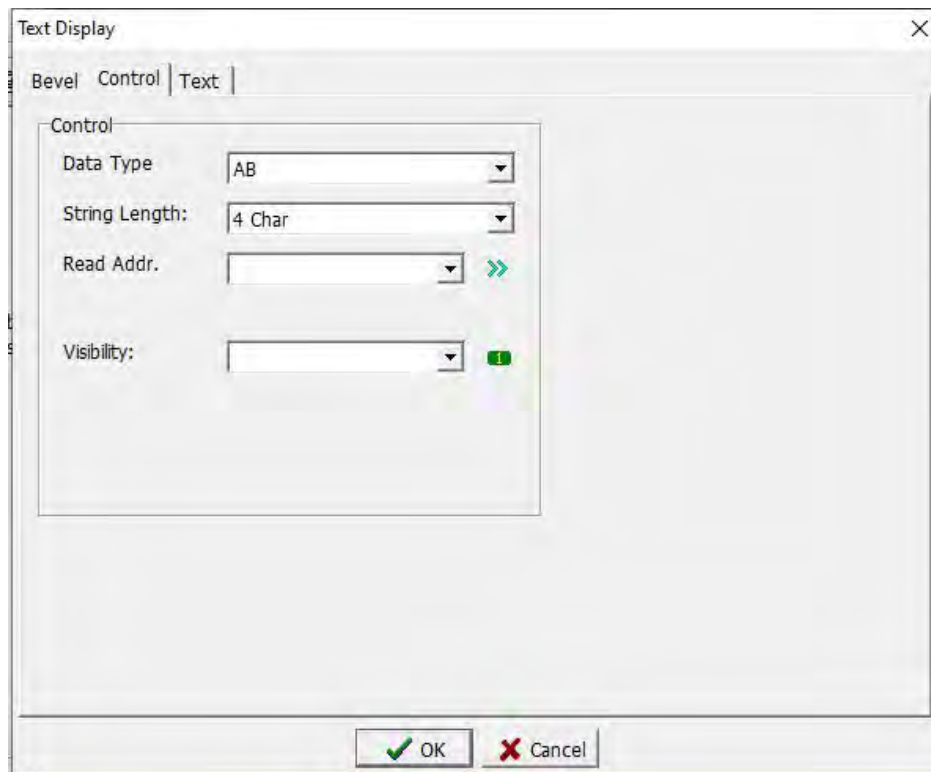

### Control

Data Format: Select the display format of the text.

String Length: Set the length of characters that can be displayed.

Read Addr. : Set the read variable address.

Visibility: Set the variable that controls the display or hiding of the text display element.

### 2. Text

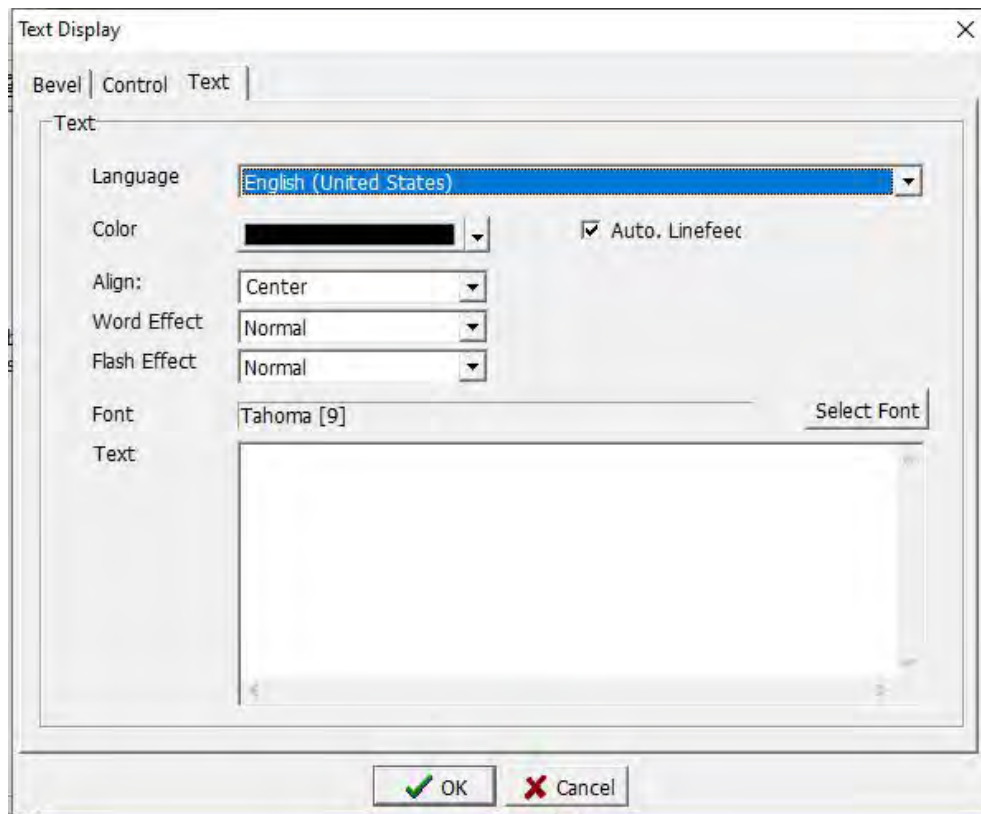

## Text

Language: Select the language type displayed.

Color: Select the color of the value displayed.

Align: Select the alignment of the numeric display.

Auto. Linefeed: Check this option, when the total length of the font is greater than the length of the component, it will automatically display the line. Otherwise, no line breaks.

Word Effect: Select whether the text display is normal or mobile.

Flash Effect: Select whether the value is normal or flashing display.

Font: Set the font type and size of the value when displaying, please refer to 3.2.1 for details.

Text: Enter the text to be displayed.

### 3.4.4 Alarm String

The detailed instructions of Bevel, please refer to chapter 3.3.1. This section only explains the different settings of Text and Option.

#### 1. Text

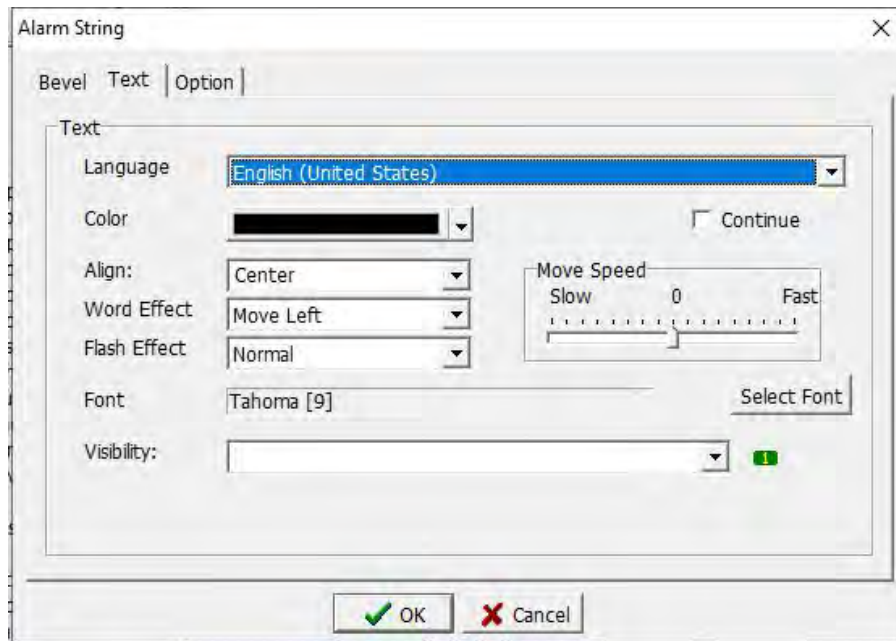

## Text

Language: Select the language type displayed.

Color: Select the color of the value displayed.

Align: Select the alignment of the numeric display.

Word Effect: Select whether the text display is normal or mobile.

Flash Effect: Select whether the value is normal or flashing display.

Font: Set the font type and size of the value when displaying, please refer to 3.2.1 for details.

Visibility: Set the variable that controls the display or hiding of this alarm text component.

Continue: Check this option, the alarm text will be displayed continuously, otherwise the alarm information will reappear after the alarm information moves and disappears in the alarm text component.

Move Speed: Set the speed of alarm text movement.

## 2. Option

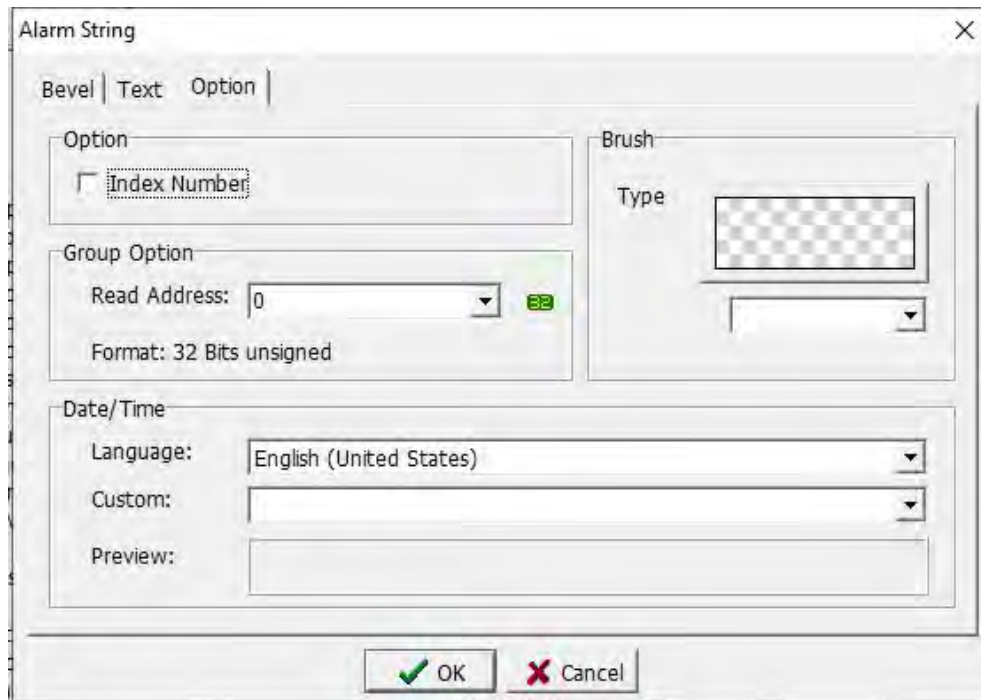

#### Option

Index Number: Check this option, the alarm text will appear with the alarm number, otherwise only the alarm text will be displayed.

#### Group Option

Read Address: Set the address of the read alarm zone.

#### Date / Time

Language: Select the language type displayed.

Custom: Set the alarm text.

Preview: Preview the display of the alarm text for easy modification in time.

#### Brush

Type: Set the brush style.

### 3.4.5 Time/Date

The detailed instructions of Bevel and Text, please refer to chapter 3.3.1. This section only explains the different settings of Control.

#### 1. Control

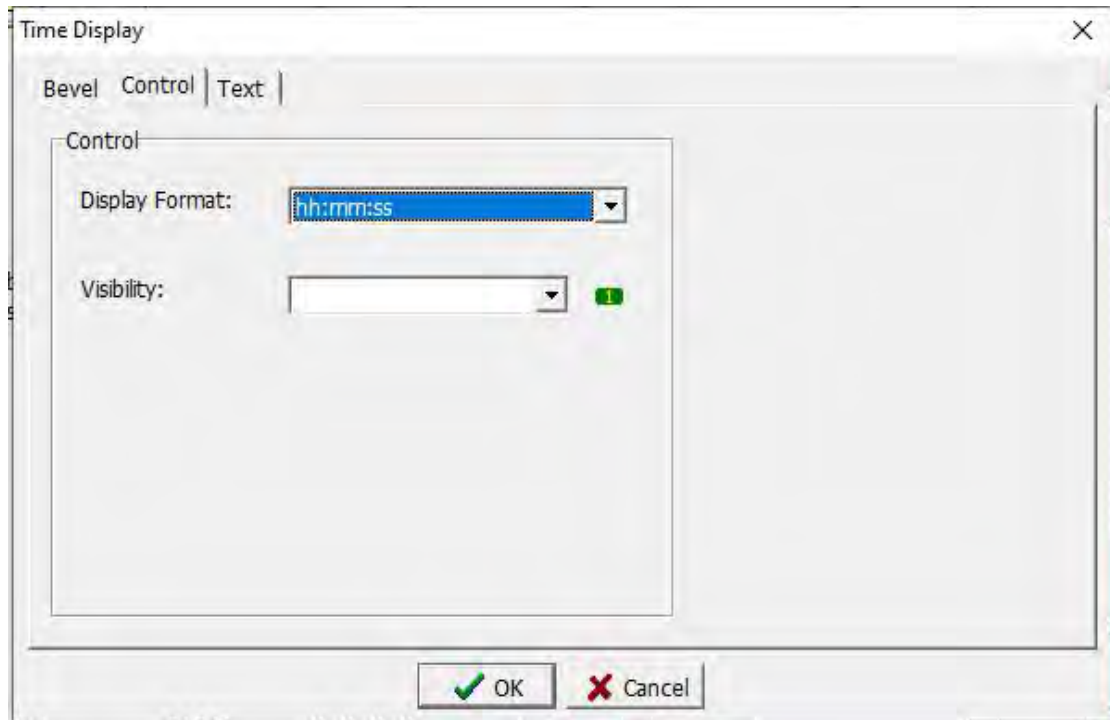

## Control

### Display Format:

Custom: When this option is selected, enter the format to be displayed in the custom format on the text page.

For the time format, refer to the table below.

hh: mm: ss: The time will be displayed as hour: minute: second.

hh:mm: The time will be displayed as hour: minute.

MM / dd / yy: The time will be displayed as month / day / year.

dd / MM / yy: The time will be displayed as day / month / year.

Dd.MM.yy: The time will be displayed as day, month, year.

Format	Descriptions	Input string	Display string
""	string	"Year"	Year
yyyy	4-digit year	yyyy	2004
yy	2-digit year	yy	04
M	1-digit month	M	7
MM	2-digit month	MM	07
d	1-digit date	d	5
dd	2-digit date	dd	05
H	1-digit hour (12 hour system)	H	9
HH	2-digit hour (12 hour system)	HH	09
h	1-digit hour (24 hour system)	h	9



hh	2-digit hour (24 hour system)	hh	09
m	1-digit minute	m	7
mm	2-digit minute	mm	07
s	1-digit second	s	7
ss	2-digit second	ss	07
AM	AM/PM	AM	AM/PMA

Visibility: Set the variables that control the display or hide of the display element.

### 3.4.6 Progress Bar

The detailed instructions of Bevel, please refer to chapter 3.3.1. This section only explains the different settings of Control.

#### 1. Control

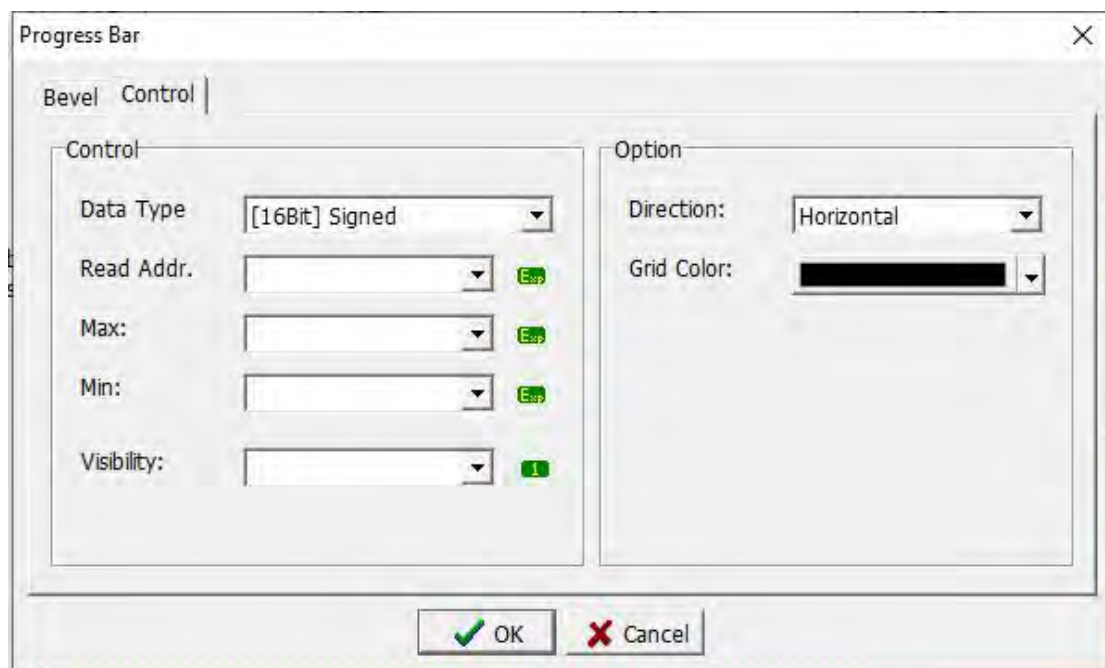

#### Control

Data Type: Select the data format to be read.

Read Addr. : Set the variable address to be read.

Max: Enter the maximum value of this contact or memory, or you can not enter it.

Min: Enter the minimum value of this contact or memory, or you can not enter it. If not, the maximum and minimum value range is the default value range of the variable.

Visibility: Set the variables that control the display or hide of the display element.

## Option

Direction: Adjust the direction of the progress bar. The default is the horizontal direction. If you select vertical, the graphics on the screen should also be adjusted to be vertical.

Grid Color: Set the color of the grid of the progress bar.

### 3.4.7 Bar/ Float Bar

The detailed instructions of Bevel, please refer to chapter 3.3.1. This section only explains the different settings of Control.

#### 1. Control

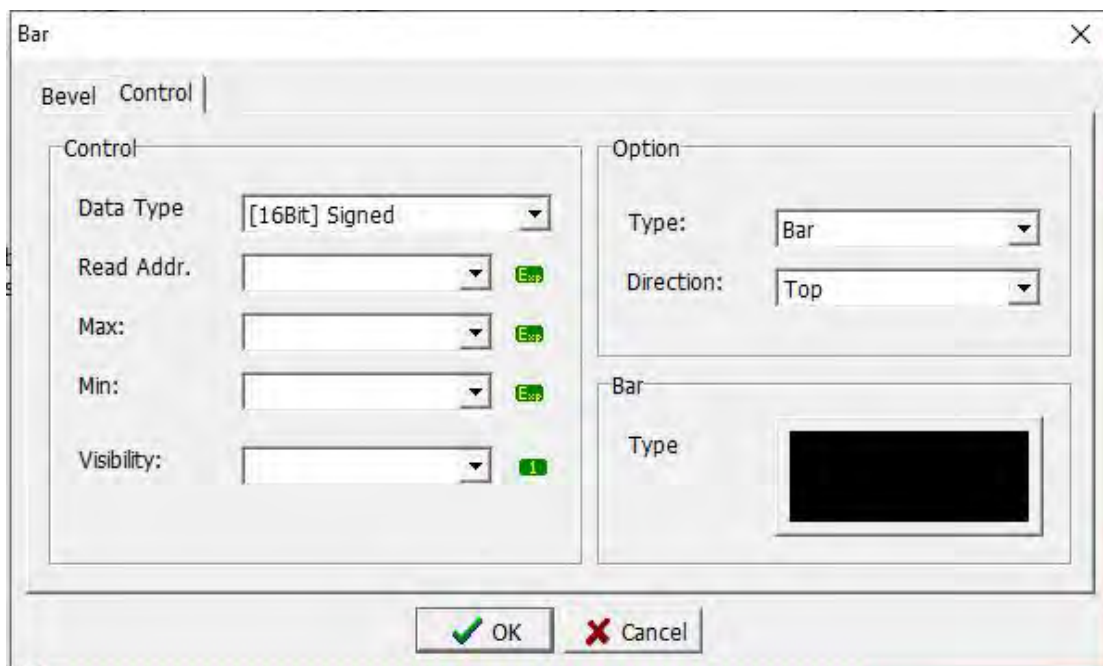

## Control

Data Type: Select the data format to be read.

Read Addr. : Set the variable address to be read.

Max: Enter the maximum value of this contact or memory, or you can not enter it.

Min: Enter the minimum value of this contact or memory, or you can not enter it. If not, the maximum and minimum value range is the default value range of the variable.

Visibility: Set the variables that control the display or hide of the display element.

## Option

Type: Select to use Bar or Float Bar.

Direction: Select the direction of Bar or Float Bar.

## Bar:

Type: Select the type of Bar or Float Bar.

### 3.4.8 Meter

The detailed instructions of Bevel and Control, please refer to chapter 3.3.1 and 3.2.4 respectively. This section only explains the settings of Scale.

#### 1. Scale

#### Scale

Graduation: Select the direction and angle of the meter display.

Master Count: Select the number of main scales.

Slave Count: Select the number of minor scales.

Length: Select the length of the scale display.

Disc size: Select the size of the disc in the center of the meter.

Scale: Tick it and scale will appear, otherwise not.

Axis: Tick it and the arc-shaped coordinate axis will appear below the scale. Otherwise not.

#### Pen

Type: Select the line style of scale and coordinate axis.

Color: Select the color of the line style.

#### Indicator Pen

Type: Select the line style of the meter pointer.

Color: Select the color of the line style.

Disc color: Select the color of the disc.

#### Option

Display Marks: Tick it and the digital marks of the main scale will appear. Otherwise not.

Max: Enter the maximum value of this contact or memory, or you can not enter it.

Min: Enter the minimum value of this contact or memory, or you can not enter it. If not, the maximum and minimum value range is the default value range of the variable.

Color: Select the color of the digital mark.

Decimal Pos.: Set the number of decimal places.

Suffix: Set the displayed quantity unit.

Font: Set the font type and size of the numeric value when displaying, please refer to 3.2.1 for details.

#### 2. Adv.



#### Fill Pie

File Pie: Tick it and Bush settings will appear, otherwise not.

Graphic Distance: Set the interval time between graphics display.

### 3.4.9 Dynamic Picture

The detailed instructions of Bevel, Image/ Picture, please refer to chapter

3.3.1 and 3.4.7 respectively. This section only explains the settings of Control.

## 1. Control



### Coordinate

Type: According to the way represented by the X and Y coordinates, the absolute value and the offset value can be selected.

### X/Y

Data Format: Set the variable data format.

Read Addr. : Set the read variable address, so as to change the position of the picture according to the value of the address.

Max: Set the maximum value of X / Y coordinates.

Min: Set the minimum value of X / Y coordinates.

### 3.4.10 Path Picture

Click [Component]-> [Status]-> [Path Picture]. When the mouse moves to the edit screen, a cross cursor will appear. When moving to the desired position, press the left mouse button, as shown in the following figure, then move to the relevant position of the desired path in sequence, then press the left mouse button, and finally confirm the path position, press the right mouse button to end the drawing.



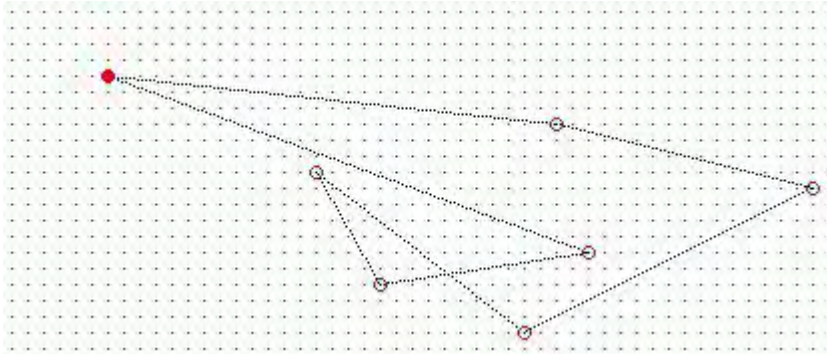

Right-click or double-click to enter the property setting page. The detailed instructions of Bevel, Image/ Picture, please refer to chapter 3.3.1 and 3.4.7 respectively. This section only explains the settings of Control.

## 1. Control

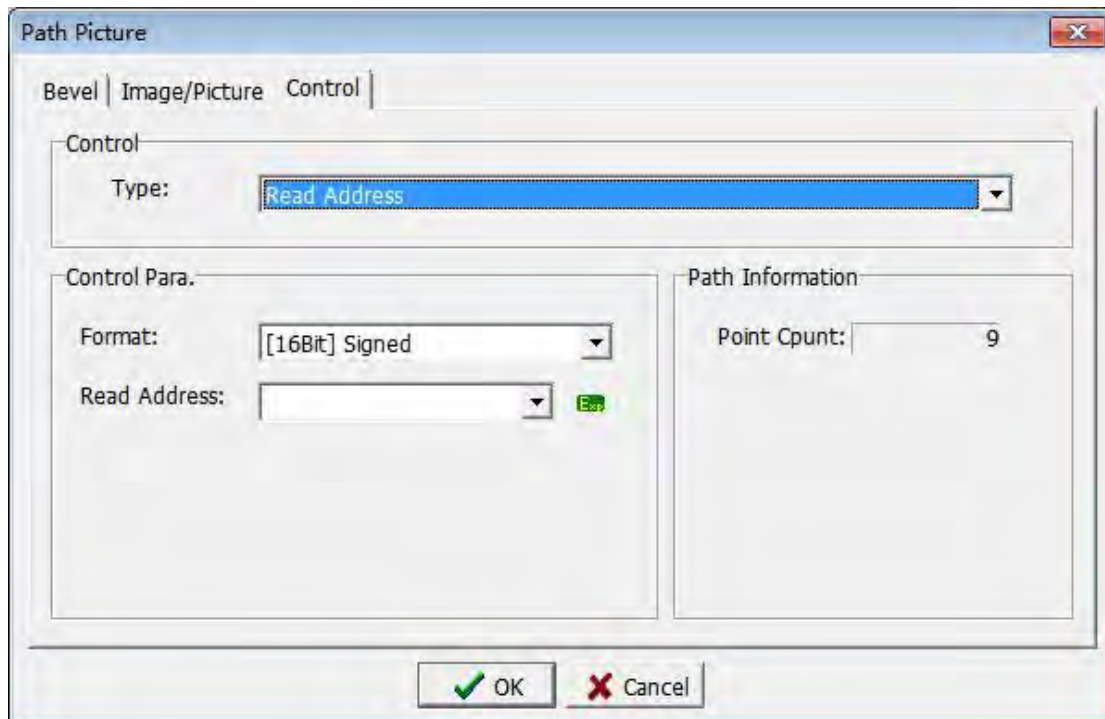

### Control

Type: There are four options including read address, increasing cycle, decreasing cycle and trapeze cycle.

Read Address: The picture moves to the corresponding coordinate point according to the value of the variable in the read position.

Inc cycle: According to the value of the variable in the read position X milliseconds, automatic coordinate increases with cyclic movement.

Del cycle: According to the value of the variable in the read position X milliseconds, automatic coordinate decreases with cyclic movement.

Trapeze cycle: The picture moves automatically in a coordinate cycle according to the value of the variable X milliseconds in the read position. When the picture is in the initial coordinate, it is an increasing cycle, and in the final coordinate is a decreasing cycle, which is equivalent to moving back and forth.

#### Control Para.

Format: Set the variable data format.

Read Address: Set the read variable address, so as to change the position of the picture according to the value of the position.

#### Path Information

Point Count: Display how many positions of the set path coordinates.

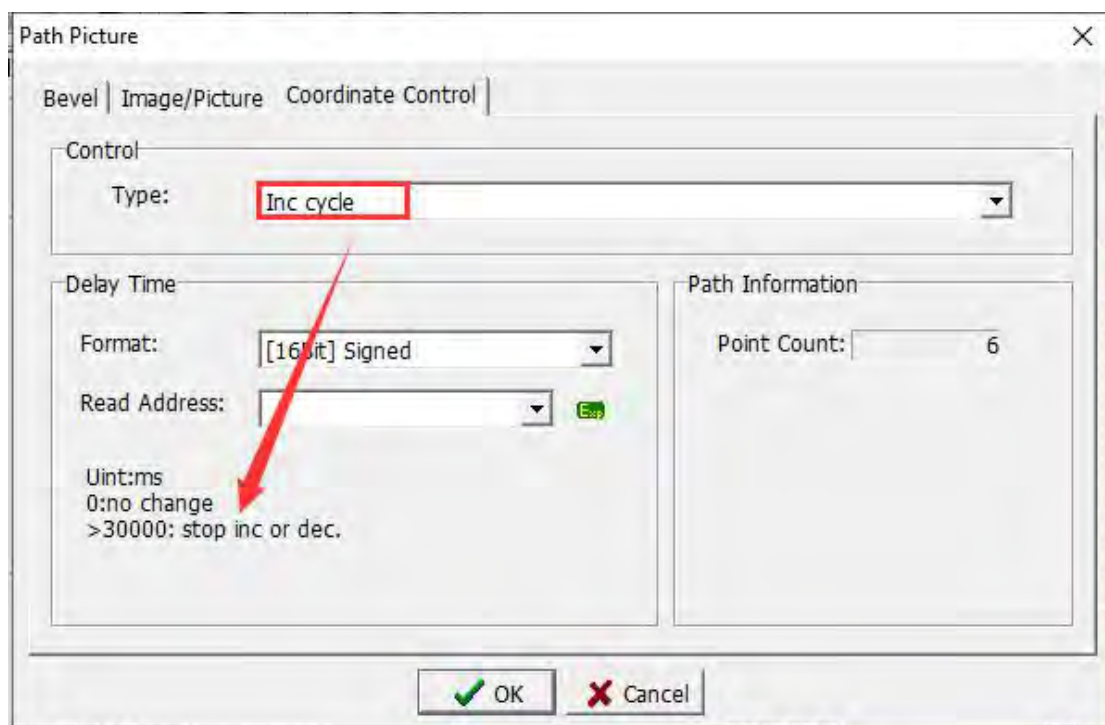

### 3.4.11 Dynamic Lamp

The main purpose is to use variable control, so that the components display different screens or different text at different positions.

Right-click or double-click to enter the property setting page. The dynamic coordinate display property setting dialog box is shown in the figure below.

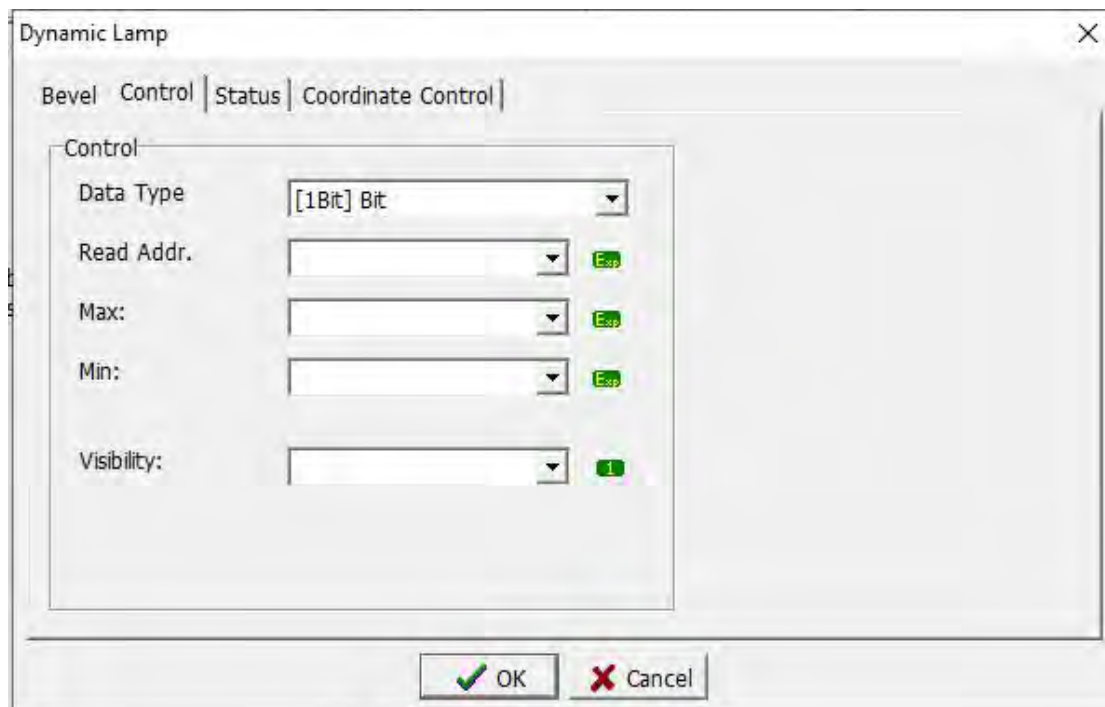

1. **Bevel:** Please refer to chapter 3.3.1 for detailed instructions.
2. **Control:** Please refer to chapter 3.3.2 for detailed instructions.
3. **Status:** Please refer to chapter 3.3.1 for detailed instructions. Only differences are explained here.

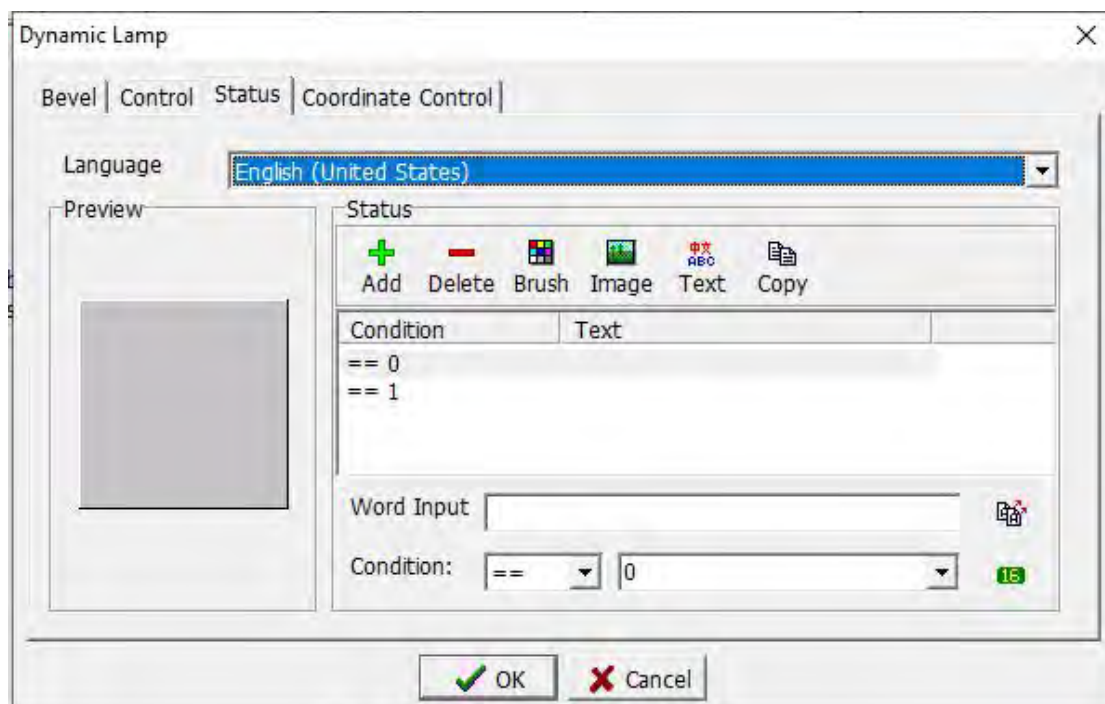

**Add:** Click this button once to add a new state.

**Delete:** Select a state and click this button once to delete the selected state.

**Copy:** Select a certain state and click this button once to copy the selected state once. The copied content includes conditions, text content, brushes, and

images.

**4. Coordinator Control:** Please refer to chapter 3.4.9 for detailed instructions.

### 3.4.12 Path Lamp

The component combines dynamic path picture and dynamic lamp. The main purpose of using the dynamic path is to display different pictures or screens when using variables to control different states. At the same time, the components can be displayed in different positions.

Click [Component]-> [Display]-> [Path Lamp]. When the mouse moves to the edit screen, a cross cursor will appear. When moving to the desired position, press the left mouse button, then move to the relevant position of the desired path in sequence, then press the left mouse button, and finally confirm the path position, press the right mouse button to end the drawing.

Right-click or double-click to enter the property setting page. The path lamp property setting dialog box is shown in the figure below.

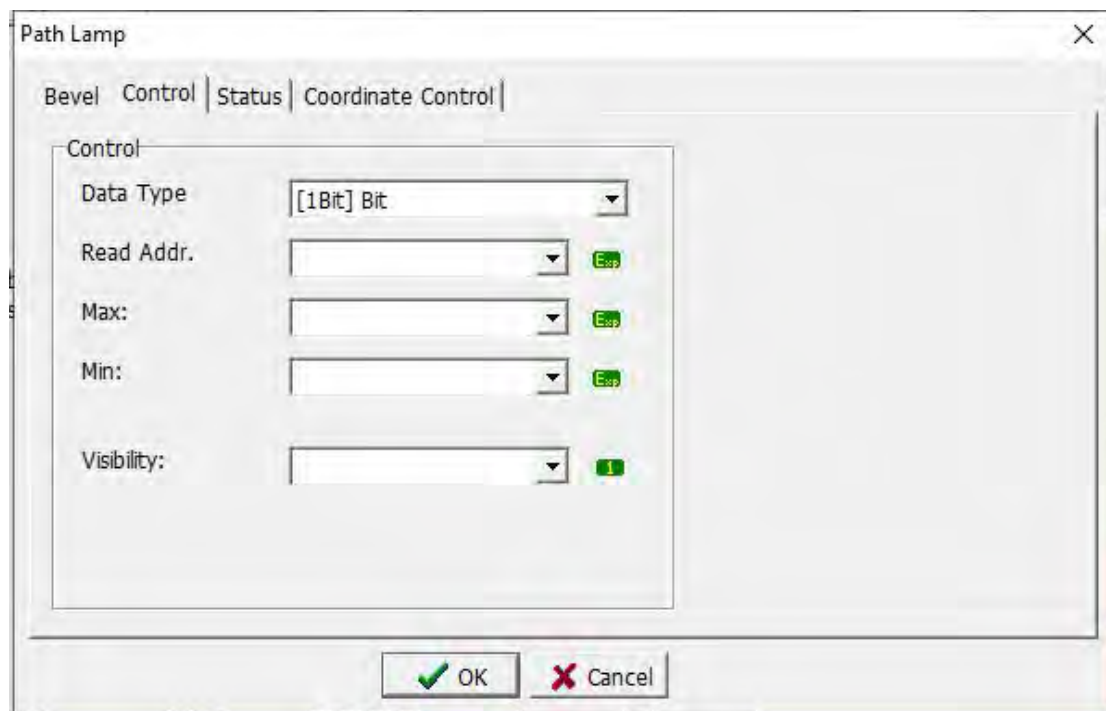

1. **Bevel:** Please refer to chapter 3.3.1 for detailed instructions.
2. **Control:** Please refer to chapter 3.3.2 for detailed instructions.
3. **Status:** Please refer to chapter 3.3.1 and 3.4.11 for detailed instructions.
4. **Coordinator Control:** Please refer to chapter 3.4.9 for detailed instructions.

### 3.4.13 Trend Graph

The man-machine interface reads the continuous data of the corresponding address and presents it to the user intuitively and graphically in real time. For example: if the display points are 50 points and three curves are

set, then a total of  $50 * 3$  data of 150 WORDs will be taken and data processing needs to be done in the PLC program.

Click [Component]-> [Display]-> [Trend Graph] to display the trend graph in the editing screen. Right-click or double-click to enter the property setting page.

**1. Bevel:** Please refer to chapter 3.3.1 for detailed instructions.

**2. Control:**

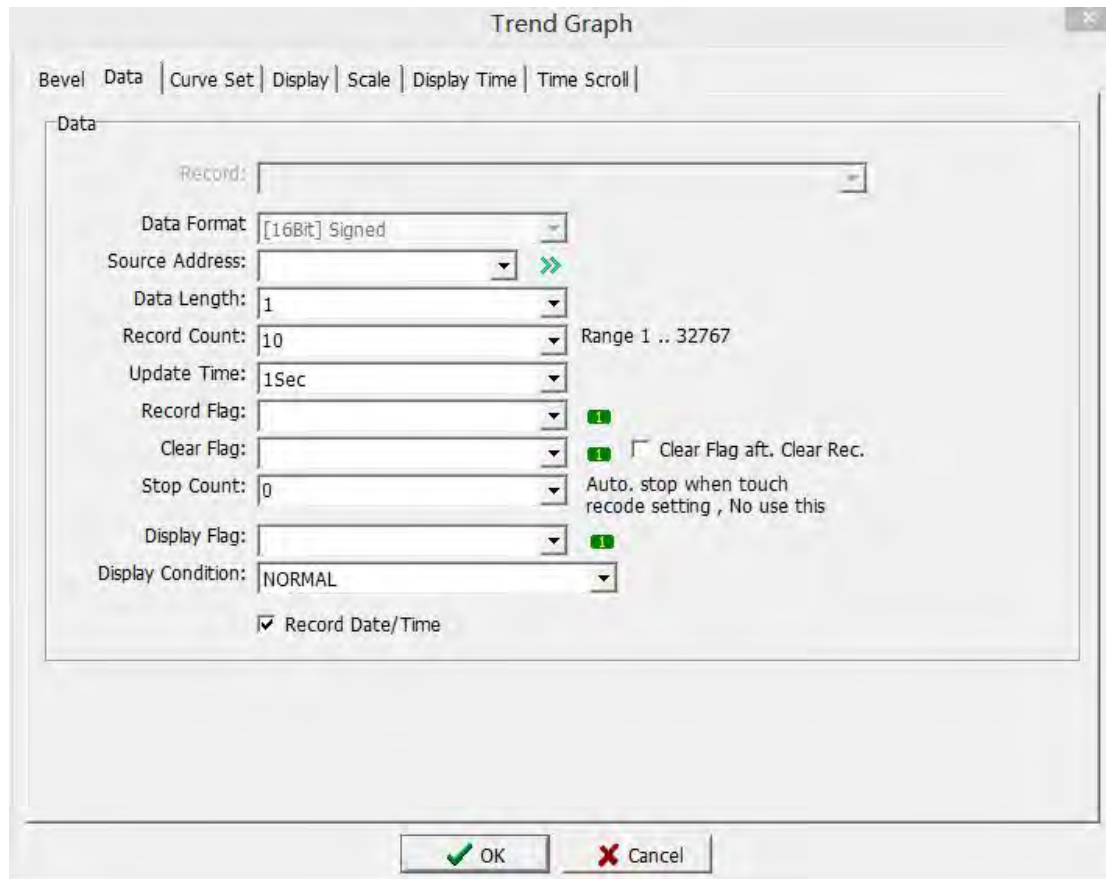

### Control

**Data Type:** Set the starting position of the register variable address for data reading.

**Source Address:** Set the length of the read data, i.e., the number of displayed curves. For example, the source address is D10 and the data length is 10, i.e., the data from D10 to D19 is read, and 10 curves are displayed in the trend graph.

**Record Count:** Set total times to record data, i.e., the maximum record times to be recorded for each curve.

**Update Time:** Set the time interval for each record of data. For example, as set in the figure above, D10 ~ D19 data is recorded once every second, and a total of 10 (number of records) are recorded.

**Record Flag:** Set the condition to start recording data, i.e., the variable



starts to record data when it is 1, and does not record when it is 0.

**Clear Flag:** Set the conditions for clearing the recorded data, that is, when the variable is 1, all data is cleared, and 0 is not cleared.

**Clear Flag aft. Clear Rec.:** Check this option to clear the flag together when clearing the recorded data.

**Stop Count:** Set the number when stop recording automatically, and set to 0 means not to use this function (the value here must be less than or equal to the number of records).

**Display Flag:** set the variable that makes the trend graph component show or hide.

**Display Condition:** Use with visibility, and display when the variable is 1 or 0. If the visibility is set to [M0] and the display condition mode is [When the variable is 1, display], then when M0=1, the trend graph is visible.

**Record Date/Time:** Check this option, the system records the time of data recording.

### 3. Curve Set

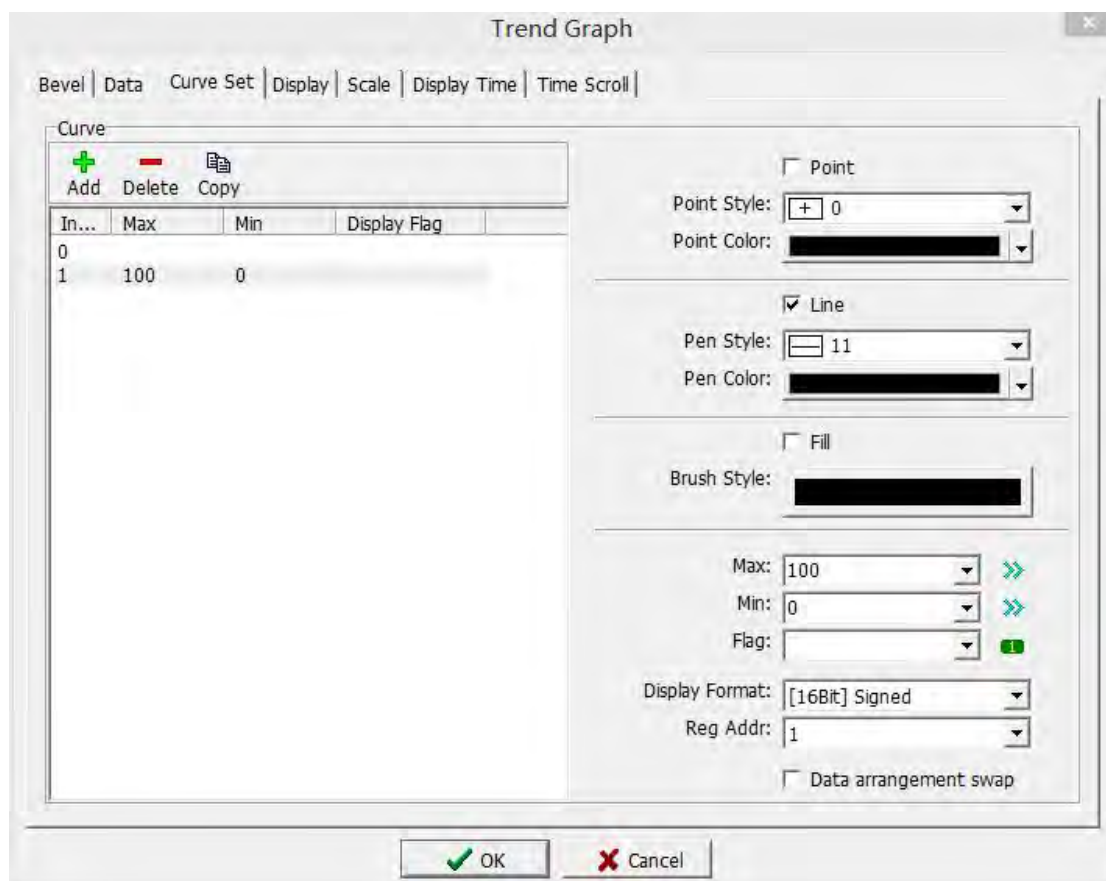

#### Curve

**Add:** Click this button to add a curve.

**Delete:** Click this button to delete the selected curve.

Copy: Click this button to copy the selected curve.

Point: Check this option, the curve is displayed in the form of points.

Point Style: Set the form of the point.

Point Color: Set the color of the point.

Line: Check this option, the curve is displayed in the form of a line.

Pen Style: Set the brush style.

Pen Color: Set the color of the pen.

Fill: Check this option, the curve is displayed in the form of a brush.

Brush Style: Set the brush style and color.

Max: Set the maximum value of a single curve.

Min: Set the minimum value of a single curve.

Visibility: Set a single curve display and hidden variables, when the variable is 1, the curve is displayed, and 0 is not displayed.

Data arrangement swap: select this option, the high and low bytes will be swapped. 16 bit: high and low BYTE swap; 32 bit: high and low WORD swap.

#### 4. Display

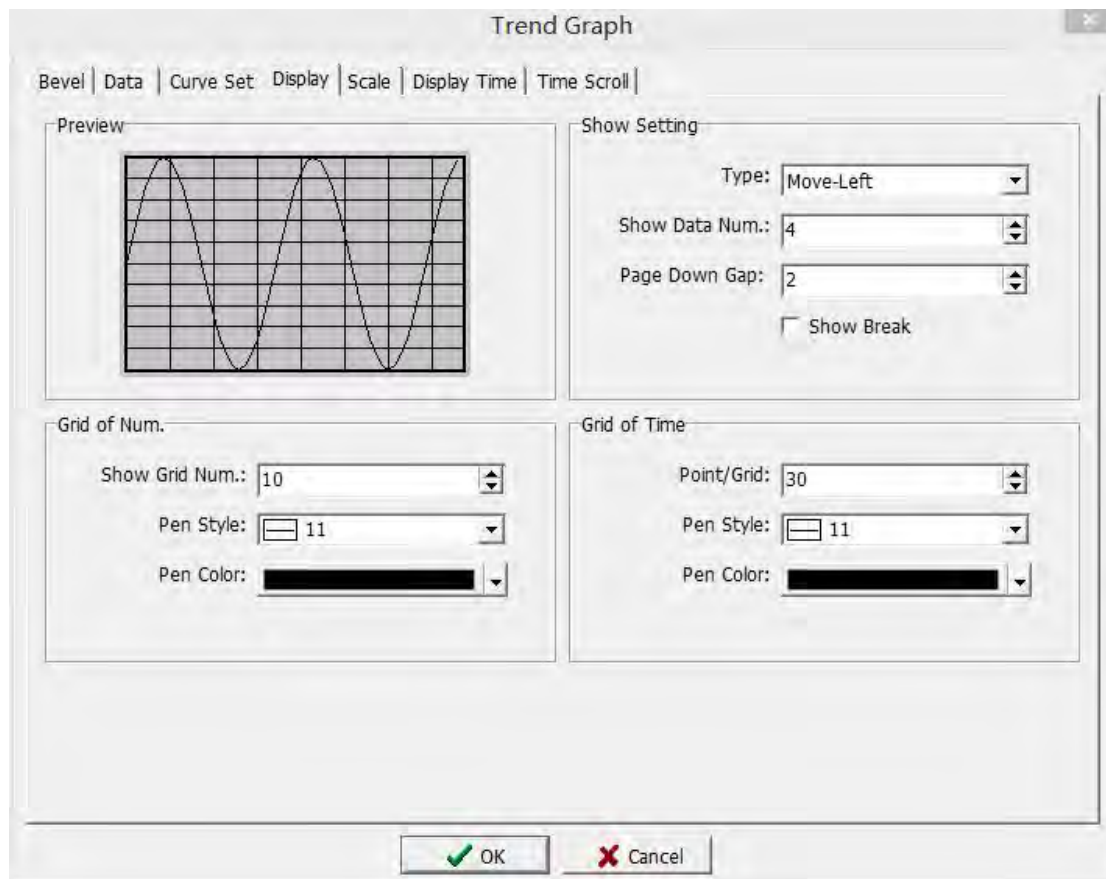

Preview: Shows the style of curve display.

Show Setting

Type: Set the direction of movement when the curve is displayed.

Show Data Num .: Set the number of points for displaying data, that is, the trend graph starts moving when it comes to the quantity of

the data set..

Page Down Gap: Set the interval between two pages when turning pages.

Show Break: Check this option, each curve is displayed with its own unique area.

Grid of Num./Time

Show Grid Num .: Set the number of grids to be displayed.

Point / Grid: Set the number of grids required for time display.

Pen Style: Set the brush style.

Pen Color: Set the color of the pen.

## 5. Scale

### Left/ Top Scale

Left / Top Scale: Check this option, the scale value will be displayed on the left side of the trend graph, and it will not be displayed when it is not checked.

Max: Set the maximum value displayed on the scale.

Min: Set the minimum value of the scale display.

Color: Set the color of the scale display on the left.

Decimal Pos.: Set whether display decimals. 0 means no decimal.

Suffix: Set the unit symbol indicated by the scale. If it is not filled in, the unit symbol will not be displayed.

Font: Set the font for the scale display. For detailed settings, please refer to the font setting in 3.2.1.

## Right/ Bottom Scale

Refer to the parameter introduction on the left/top scale.

## 6. Display Time



### Display time

**Display Time:** Check this option to display the time of recorded data below the trend graph.

**Display format:** Set the time display format.

**Color:** Set the color of time display.

**Font:** Set the font for time display.

### Start Record Time

**Start Record Time:** Check this option, the upper left of the trend graph displays the time to start recording data.

### End Record Time

**End Record Time:** Check this option, the time at the top right of the trend graph shows the time when the data recording is ended.

## 7. Time Scroll

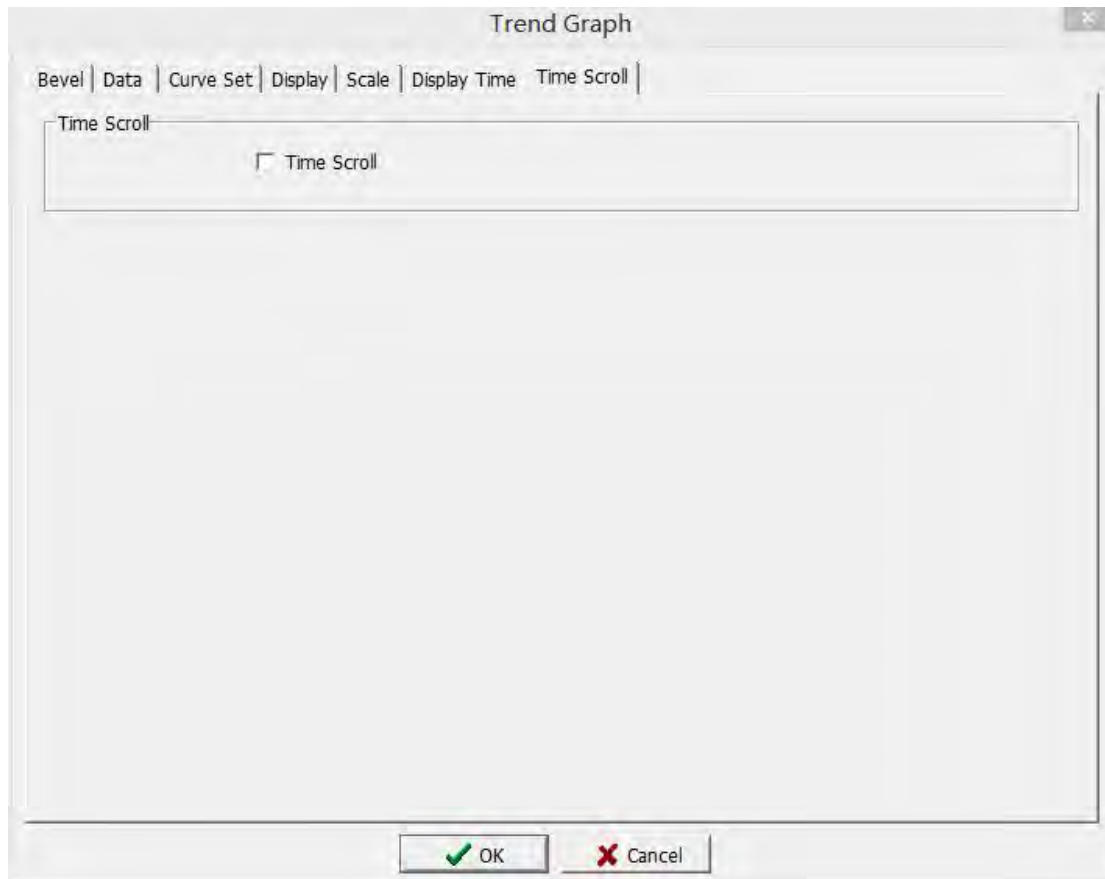

#### Time Scroll

Time Scroll: Check this option, the time scroll will display under the trend graph.

### 3.4.14 Historical Trend

The man-machine interface reads the continuous data of the corresponding address and presents it to the user intuitively and graphically in real time.

Click [Component]-> [Display]-> [Historical Trend] to display the historical trend in the editing screen. Right-click or double-click to enter the property setting page. Historical trend graph property dialog box as shown below.



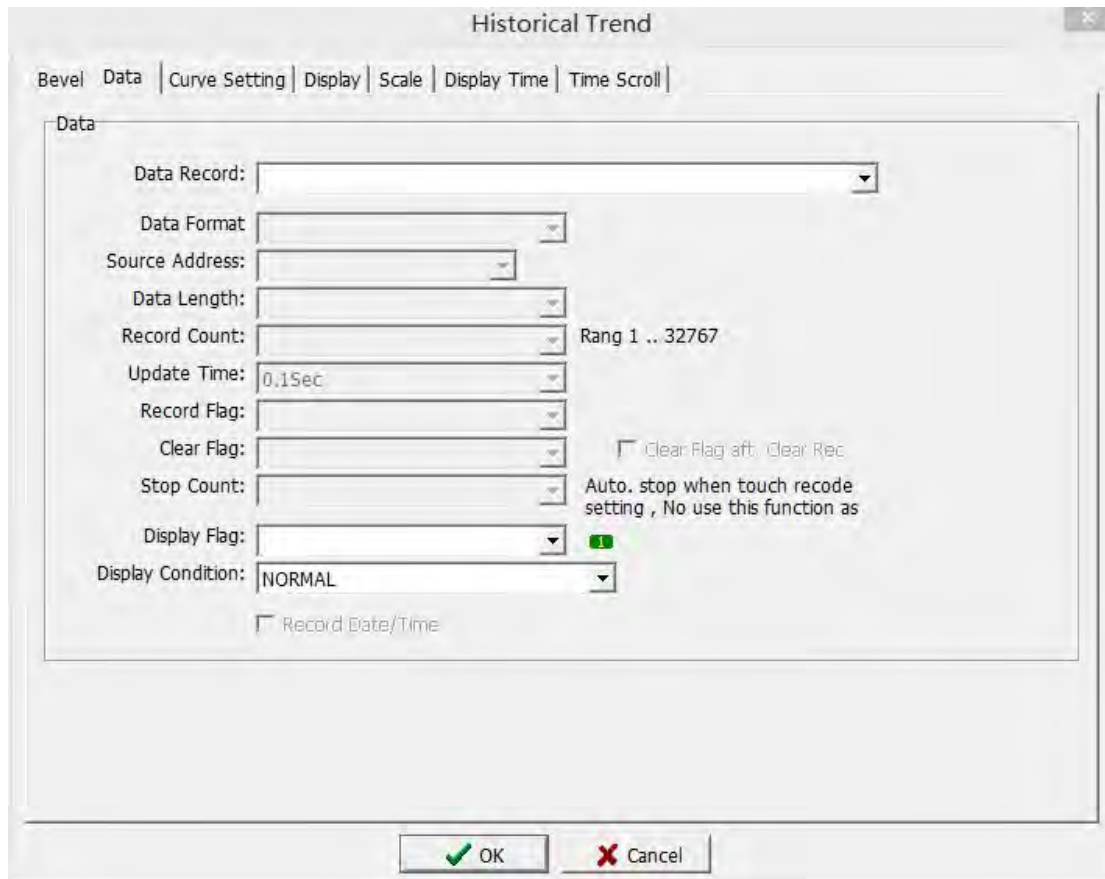

1. Bevel: Please refer to chapter 3.3.1 for detailed description.
2. Control: as shown above.

#### Data

Data Record: Select the required data record in the data record management as the display of the historical trend graph. For the detailed data setting, please refer to Section 2.4.11

3. Curve setting: For details, please refer to section 3.4.13 Curve Setting Page Setting.
4. Display: For details, please refer to section 3.4.13 Display page settings.
5. Scale: For details, please refer to section 3.4.13 Scale page settings.
6. Time display: For details, please refer to section 3.4.13 Time display page settings.
7. Time scroll bar: For details, please refer to section 3.4.13 Time scroll bar page settings.

### 3.4.15 Record Table

The man-machine interface reads the continuous data of the corresponding address in the programmable controller, and can also be presented to the user in the form of a table.

Click [Component]-> [Display]-> [Record Table] to display the record data table in the editing screen. Right-click or double-click to enter the property

setting page. The record data table property setting dialog box is shown in the figure below.

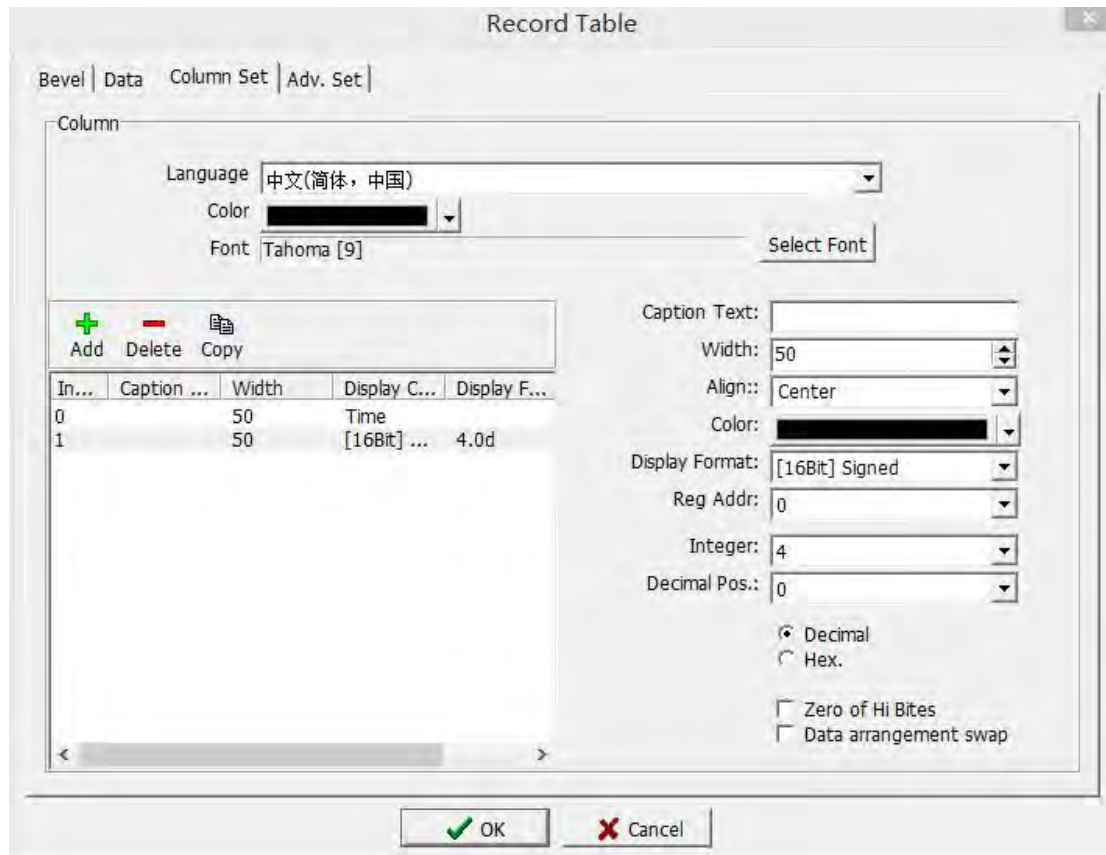

1. **Bevel:** For details, please refer to Section 3.3.1.
2. **Control:** For details, please refer to Section 3.4.13.
3. **Column Set:** as shown below.

#### Column

Language: Set the language to be used.

Color: The text color in the table.

Font: Set the font in the table.

Add: Click this button to add a column of data information to be displayed.

Delete: Click this button to delete the selected data column information to be displayed.

Caption Text: Set the title of the data to be displayed in the selected column.

Width: Set the width required for displaying the selected column data.

Align: Set the alignment of the selected column data display.

Color: Set the color when the selected column data is displayed.

Display Format: Set the data source for the selected column data display.

Integer: Set the number of integer digits when the selected column data is displayed.

Decimal Pos.: Set the number of decimal places when the selected column data is displayed.

Zero of Hi Bites: Check this option to perform zero padding automatically

when there is no data in the high position.

Decimal: Select this option, the data is displayed in decimal form.

Hex .: Select this option, the data is displayed in hexadecimal form.

Data arrangement swap: select this option, the high and low bytes will be swapped. 16 bit: high and low BYTE swap; 32 bit: high and low WORD swap.

#### 4. Adv. Set

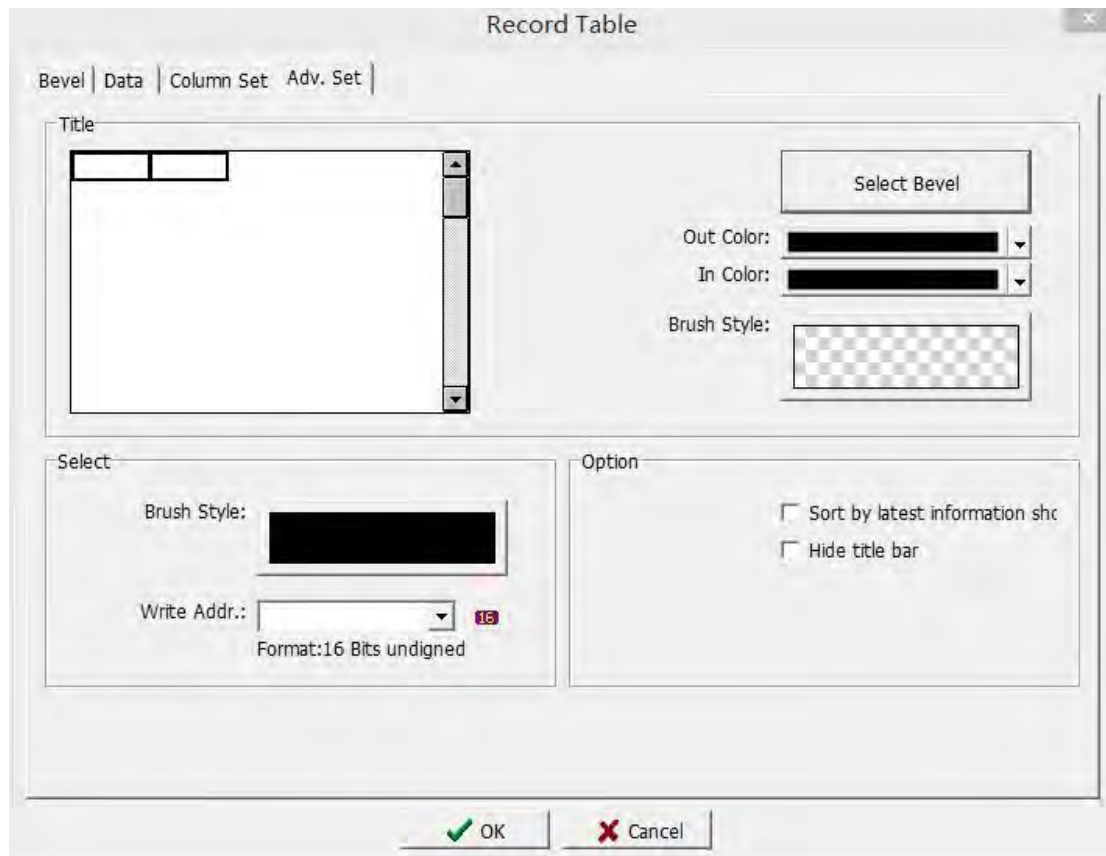

##### Title

Select Bevel: Set the display style of the title bar border. For details, please refer to Chapter 3.3.1.

Out Color: Set the color of the outer frame of the title bar.

In Color: Set the color of the inner frame of the title bar.

Brush Style: Click the brush button and select the brush style in the pop-up dialog box.

Select: When a row of data is selected, the display form of that row.

Brush Style: Set the brush style of the selected row.

Write Addr. : Set a 16-bit unsigned number, and display the selected line number in the 16-bit unsigned number.

##### Option

Sort by latest information shows: Check this option to display the latest data at the front when displaying. Otherwise, the latest data is displayed at the last.

Hide title bar: check this option. Hide the header column of the table.

### 3.4.16 Alarm Display/ Alarm Count Display/ Current Alarm Display

Click [Component]-> [Display]-> [Alarm Display]/ [Alarm Count Display]/ [Current Alarm Display] to add an alarm component to the edit screen, as shown in the figure below.

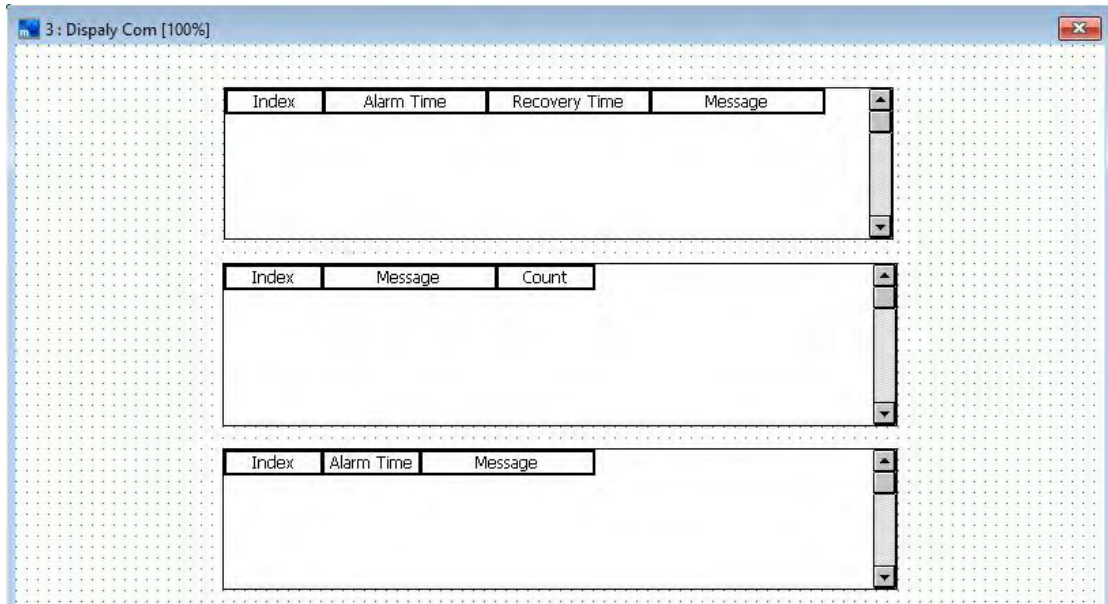

Right-click or double-click to enter the property setting page. The dialog box for setting the alarm table properties is shown below.

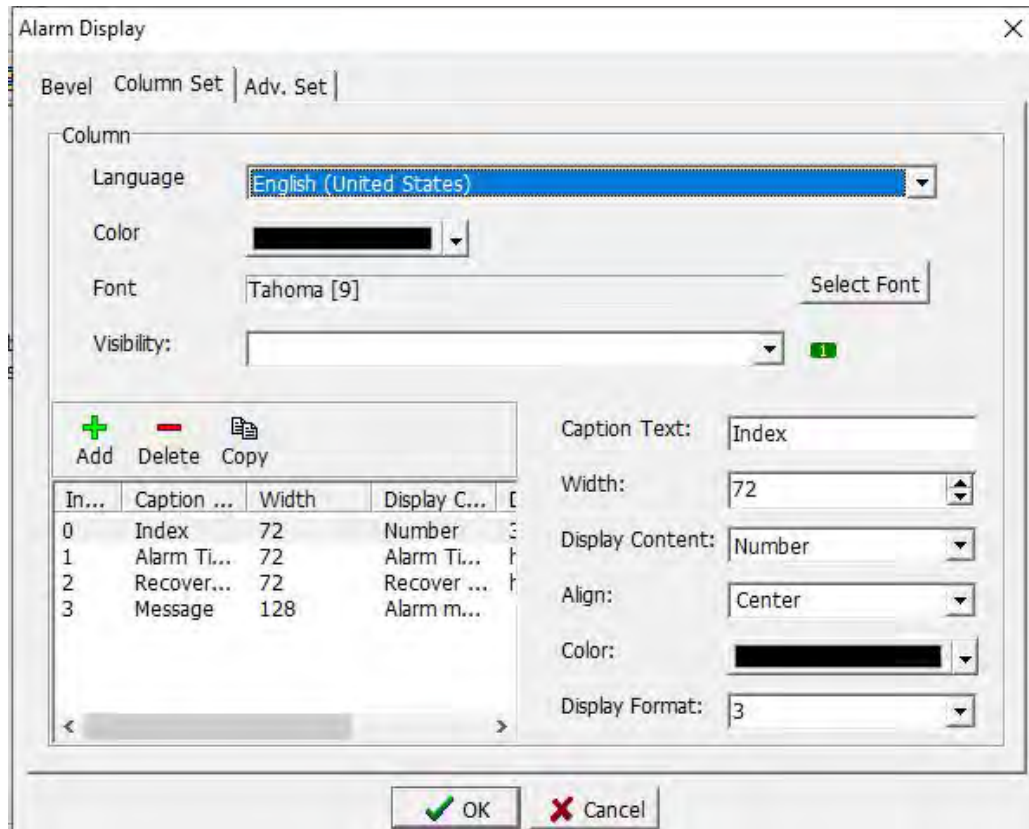

1.Bevel: refer to 3.3.1

2.Column Set: as above picture.

#### Column

Language: Select the language displayed.

Color: Select the color of the title text.

Font: Select the font to be displayed in the title text.

Display Flag: Sets the variable position where the alarm element is shown or hidden.

Caption Text: Set the text to be displayed for the selected title.

Display width: Set the width of the selected title bar.

Display content: Set the alarm content to be displayed in the selected title bar.

There are five options: alarm time, recover time, message, number, and passed time.

Alignment: Set how text or data is aligned when the column of the selected title is displayed.

Display color: Set the color of the selected display content.

Display Format: Set the format of the selected title display. Depending on the display content selection, the selection provided by the format here is also different.

**3. Advanced settings:** The page is shown below.



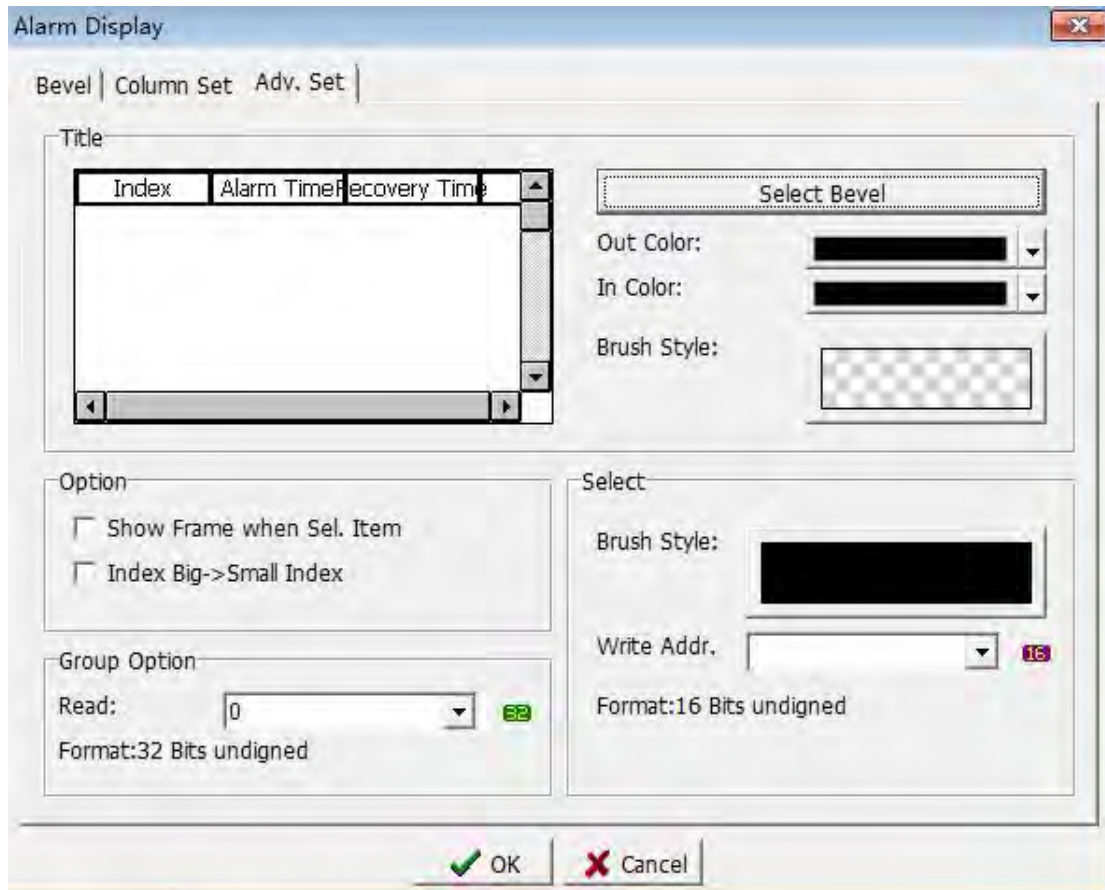

### Title

For detailed settings, refer to the parameter settings in the title bar of the advanced setting page in section 3.4.15.

### Option

“Show Frame when Sel. Item”: When this option is selected, if the alarm display is selected, the corresponding viewing screen that is set is displayed. If no selected, it is not displayed.

“Index Big->Small Index”: When this option is selected, the alarm serial numbers are displayed in descending order of index values.

### Group option

Read position: Set the read position, which can be selected as the alarm group you want to read.

### Select

For detailed settings,, refer to the parameter settings in the selection items of the advanced setting page in section 3.4.15.

## 3.4.17 Status Polygon

Click [Component]-> [Display]-> [Status Polygon]. When the mouse is moved to the edit screen, a cross cursor will appear. Press the left mouse button when moving to the desired position, then move to the relevant position of the desired path in sequence and then press the left mouse button. After

confirming the path position, press the right mouse button to end drawing. As shown below.

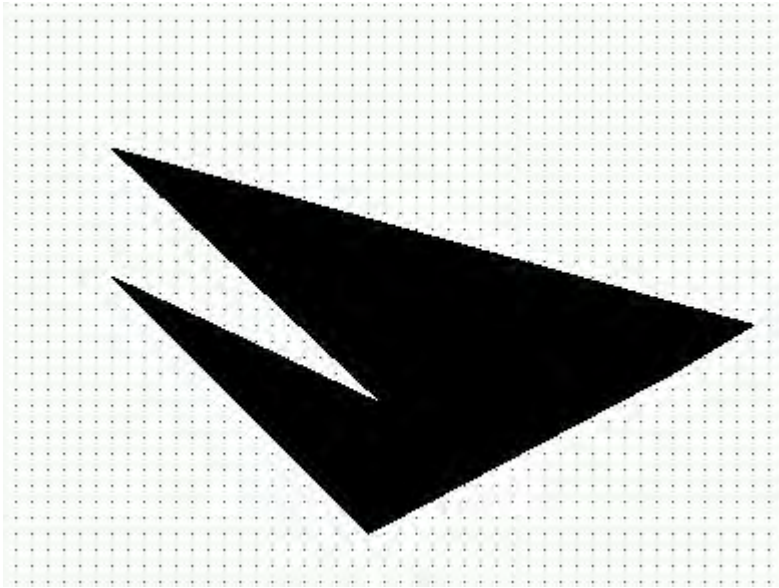

Right click or double click to enter the property setting page. The Status Polygon property setting dialog box is shown in the figure below.



- 1. Location:** Refer to section 3.2.1
- 2. Control:** Refer to section 3.4.2.
- 3. Status:** The page is shown below.



### 3.4.18 Graph

The HMI reads the continuous data of the corresponding address in the programmable controller. In addition to displaying it to the user in the form of trend graphs and tables, it can also choose to display it to the user in the form of a graph.

Click [Component]-> [Display]-> [Graph] to display the graph in the editing screen. Right click or double click to enter the property setting page. The graph property setting dialog box is shown in the figure below.

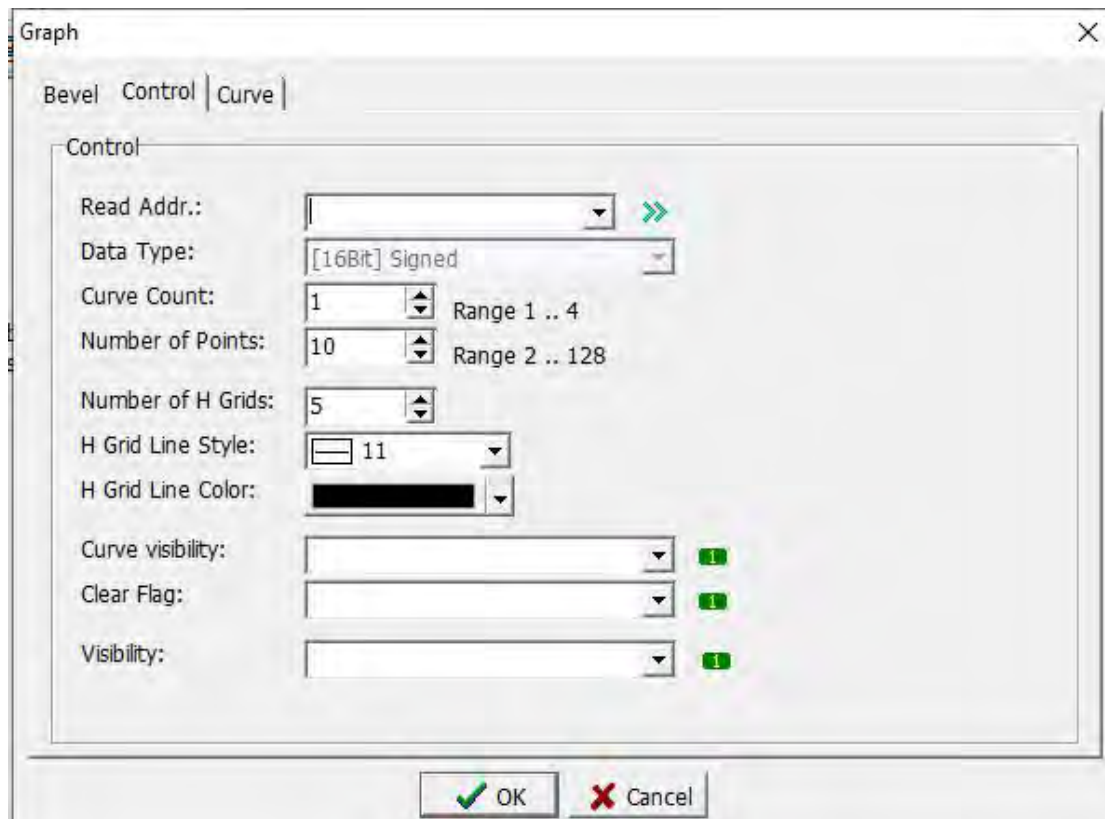

**1. Bevel:** refer to section 3.3.1.

**2. Control:** The page is as shown above.

**Read Addr.:** Set the address of the variable to be read. The first variable is the number of points, and the value is less than or equal to the display point setting value. The reading address starts from the second variable of the reading position. As shown in the figure above, D10 reads number of points,  $D10 < 10$  (display the number of points setting value), read data from D11.

**Data Type:** Only 16-bit signed numbers are available.

**Curve count:** Set the number of curves to be displayed. The setting range is 1 ~ 4.

**Number of Points:** Set the number of points to be displayed for each curve, that is, the number of registers to be used. The setting range is 2 ~ 128.

**Number of H Grids :** Set the number of horizontal grid lines in the graph.

**H grid line Style:** Set the display form of the horizontal grid line in the graph.

**H grid line color:** Set the color of horizontal grid lines in the graph.

**Curve display flag:** Set the variable position to make the curve show or hide. When the condition is reached, the curve is displayed.

**Clear flag:** Set the variable position of the clear curve. When the condition is reached, the displayed curve is cleared.

**Visibility:** Set the variable position that makes the graph component show or hide. When the condition is reached, the graph is displayed.

**Note:** As shown in the figure above, if the number of curves is set to 1, only one curve is displayed, so the number of points displayed on the curve is a line chart composed of a total of 10 points D10-D19.

As shown in the figure above, if the number of curves is set to 2, two curves need to be displayed. At this time, the 10 points of the first curve are D10 / D12 /...../ D28 and the 10 points of the second curve are D11 / D13 /.../ D27.

If The number of curves is set to other, the number of points displayed on the curve can be like this sample, and so on.

**3.Curve :** The page is as shown in the figure below.

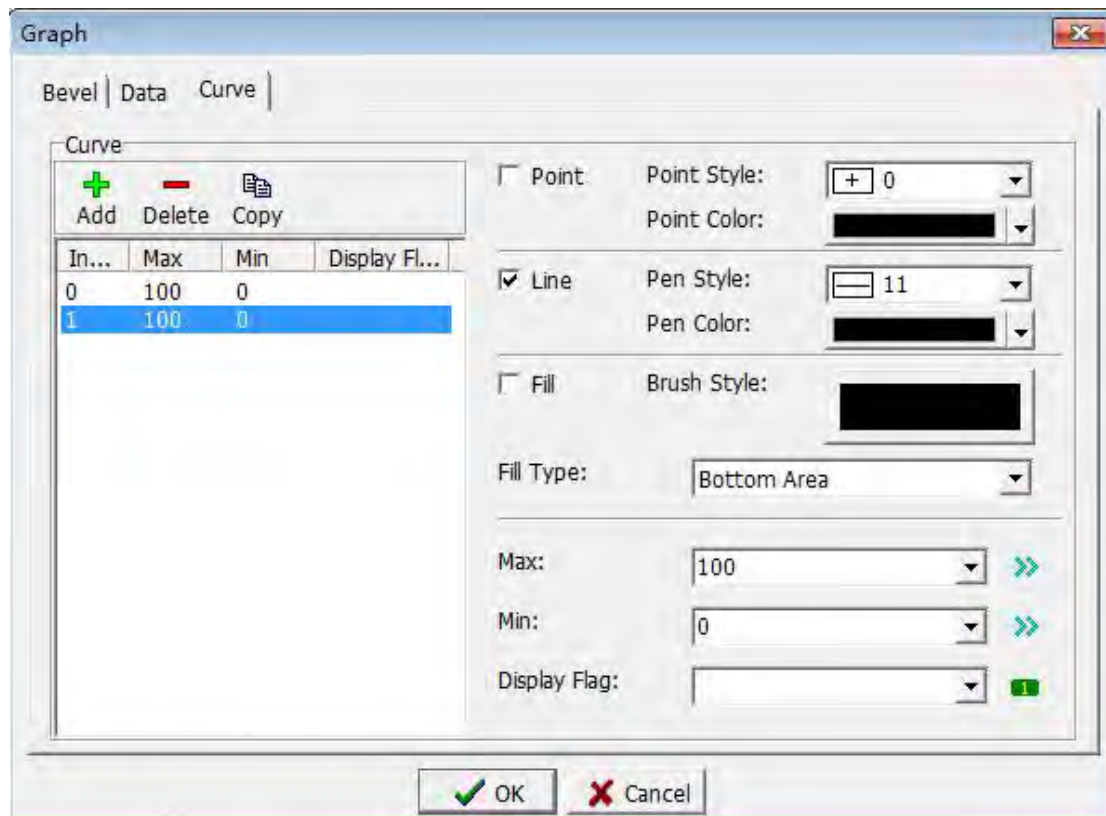

**Add:** Click this button to add a new state. When in multiple states, different states are displayed according to the read variable data.

For detailed parameter settings, refer to section 3.4.13.

**Pen Style:** Set the pen form.

**Brush color:** Set the color of the brush.

**Brush form:** Set the form and color of the brush.

**Fill Type:** Set "which direction area to fill" when selecting the fill area.

**Delete:** Click this button to delete the selected state.

**Copy:** Click this button to copy the selected state.

### 3.4.19 XY Graph

The HMI reads the continuous data of the corresponding address in the programmable controller. In addition to displaying it to the user in the form of a trend chart and a table, it can also choose to display it to the user in the form of



an XY curve.

Click [Component]-> [Display]-> [XY Graph] to display the XY graph in the editing screen. Right click or double click to enter the property setting page. The graph property setting dialog box is shown in the figure below.

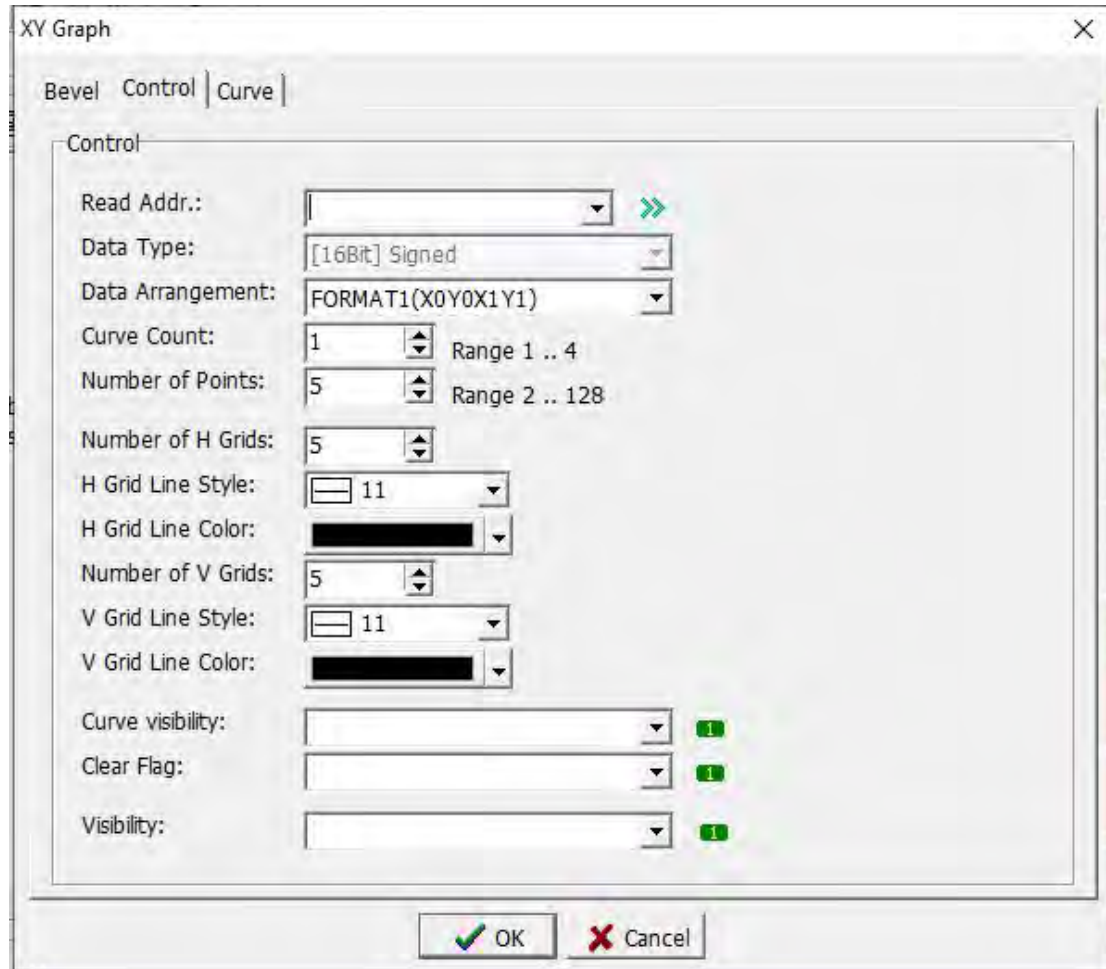

**1. Bevel:** refer to section 3.3.1.

**2. Control:** as shown above.

(Refer to 3.4.18 for specific settings. Only the differences are described here.)

Number of H Grids: Set the number of vertical grid lines in the XY graph.

V grid line Style: Set the vertical grid line display format in the XY graph.

V grid line Color: Set the color of vertical grid lines in the XY graph.

For example

Set as above, the number of graph is 2, and the number of displayed points is 5, that is, two graphs are displayed, and each graph consists of 5 points. The read position is D10 and the format is X0X1Y0Y1.

When displaying a graph, the value of D10 indicates the number of graph points. This value can be set, and must set be less than or equal to the number of displayed points. When the set value is greater than the number of displayed points, the system treats as the set value equal to the number of

displayed points.

Data arrangement X0X1Y0Y1:

Reads a total of 20 register data of D11-D30, where D11-D20 is the value of the first graph, and the coordinates of the 5 points are (D11, D16) (D12, D17) (D13, D18) (D14, D19) (D15, D20). Then D21-D30 are the values of the second graph, and the coordinates of the five points are (D21, D26) (D22, D27) (D23, D28) (D24, D29) (D25, D30).

If the secondary material arrangement is selected as X0Y0X1Y1

It means read a total of 20 register data of D11-D30, where D11-D20 is the value of the first graph, and the coordinates of 5 points are (D11, D12) (D13, D14) (D15, D16) (D17, D18) (D19, D20). Then D21-D30 are the values of the second graph, and the coordinates of the five points are (D21, D22) (D23, D24) (D25, D26) (D27, D28) (D29, D30).

### 3. Curve: refer to section 3.4.13

#### 3.4.20 QR code

Can store some simple ASCII characters, that is, all uppercase and lowercase letters, numbers 0 to 9, punctuation marks, etc.;

In the touch screen, it can be used with the [text editing] control, and the user can scan the corresponding QR code to get the corresponding information.

The image shows a software dialog box titled "QR Code". It has two tabs: "Bevel" and "Data". The "Data" tab is selected. Inside the "Data" section, there are five rows of controls: "Data Format" with a dropdown menu showing "AB"; "String Length" with a dropdown menu showing "4 Char"; "Read Addr." with a dropdown menu and a green double arrow icon; "Display Flag" with a dropdown menu and a green square icon; and "Display Condition" with a dropdown menu showing "NORMAL". Below this is the "QRCode" section, which includes: "Error Correction rate" with a dropdown menu showing "H(30%)"; "Foreground color" with a color selection dropdown showing black; "Background Color" with a color selection dropdown showing white; "Prefix Text" with an empty text input field; and "Suffix Text" with an empty text input field. At the bottom of the dialog are two buttons: "OK" with a green checkmark icon and "Cancel" with a red X icon.

1. Bevel: Please refer to section 3.2.1 for detailed page description.
2. Control: The page is shown in the figure above.

## Control

Data Format: select the format of the text string corresponding to the writing position

0, AB: The first word is written into the high bit of the variable, and the second word is written into the low bit of the variable.

1. BA: The second word is written into the high bit of the variable, and the first word is written into the low bit of the variable.

2. \_A: Each variable only stores one text in the low position.

3. A\_: Each variable only stores one text in the high position.

4~7. Same as 0~3, except that no text is displayed, only "\*" is displayed.

String length: Set the number of characters to be displayed, 1~64 characters can be displayed.

Reading Addr.: Set the variable position of QR code display.

Display Flag: Set the variable position to show or hide the QR code.

Display Condition: Use with visibility, and display when the selectable variable is 1 or 0.

If the visibility is set to [M0] and the display condition mode is [When the variable is 1, display], when M0=1, the QR code display is visible.

## QR code

Error correction rate: It means that the QR code can be scanned normally after being blocked, and the maximum area that can be blocked is the error correction rate;

The higher the error correction rate, the larger the part of the two-dimensional code picture that can be blocked. (Note: The three positioning boxes on the side of the QR code and the small positioning block in the middle cannot be blocked, otherwise the error correction rate cannot be scanned even if it is high.)

The error correction rate of the two-dimensional code is indicated by letters, and the error correction ability level is divided into four levels: L, M, Q, and H:

L	7%
M	15%
Q	25%
H	30%

Foreground color: set the color of the QR code pattern.

Background color: Set the background color of the QR code.

Prefix text: Set the front text displayed after scanning the QR code, for example, you can set the company logo, address, etc.

Suffix text: Set the text displayed after scanning the QR code, such as company phone, etc.

### 3.4.21 Pipe Line

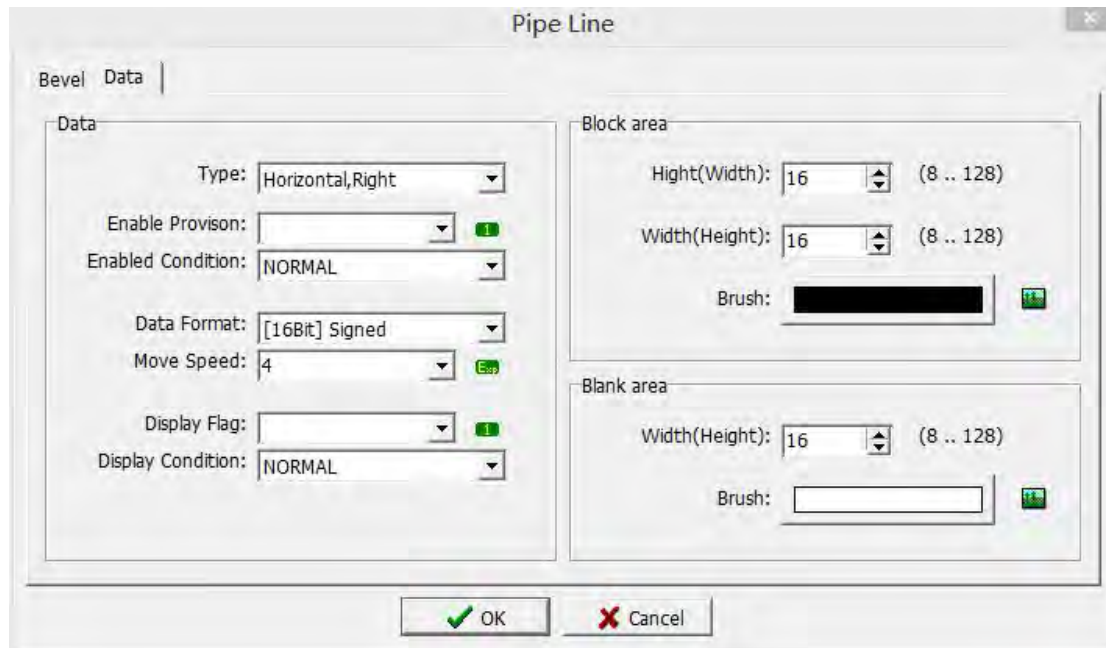

1. Bevel: Please refer to chapter 3.2.1 for detailed page description.
2. Control: The page is shown in the figure above.

#### Control

**Type:** Set the flow direction of the pipe line. Options: Horizontal to the left; Horizontal to the right; Vertically downwards; Vertically upwards.

**Enable Provision:** Set the condition variable. When the set variable is 1 or 0, the pipe line can execute the corresponding action, otherwise the pipe line will not act.

**Enable Condition:** Used in conjunction with controlled condition, when the variable can be set to 1 or 0, it is controlled. If the controlled condition is set to [M1] and the controlled condition mode is [when the variable is 1, controlled]; when M1=1, the pipe line can execute the corresponding action, otherwise the pipe line does not act.

**Data Format:** Select the format of the data to be written.

**Move Speed:** Set the movement speed of the pipe line, the larger the value, the faster the movement speed.

**Display Flag:** Set the variable position to show or hide the pipe line.

**Display Condition:** Use with visibility, and display when the selectable variable is 1 or 0.

If the visibility is set to [M0] and the display condition mode is [When the variable is 1, display], when M0=1, the pipe line display is visible.

#### Block/blank area

**Height (width):** Set the height and width of the flowing block/blank block.

**Brush:** Please refer to section 3.1.1 for page details.

### 3.5 Edit

After the HMI is connected to the programmable controller, some data in the programmable controller can be modified by the editing component. At this time, the editing component is used to complete the modification operation.

Click [Component]-> [Edit]-> to find different edit option as figure 3.5-1, or directly click the option from the tool shortcut bar, as figure 3.5-2

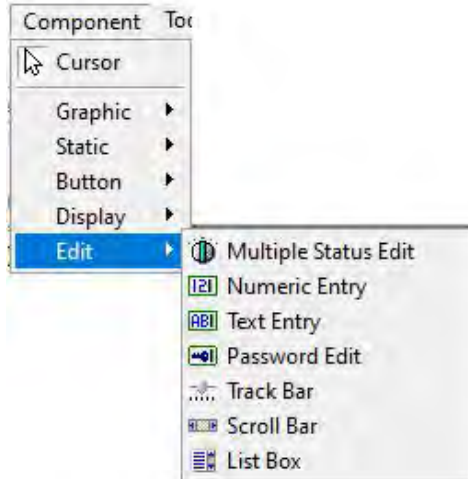

3.5-1



3.5-2

### 3.5.1 Multiple Status Edit

Click [Component]-> [Edit]-> [Multiple Status Edit] to display the mutil Status Edit element in the edit screen. Right click or double click to enter the property setting page. The mutil Status Edit property setting dialog box is shown in the figure below.



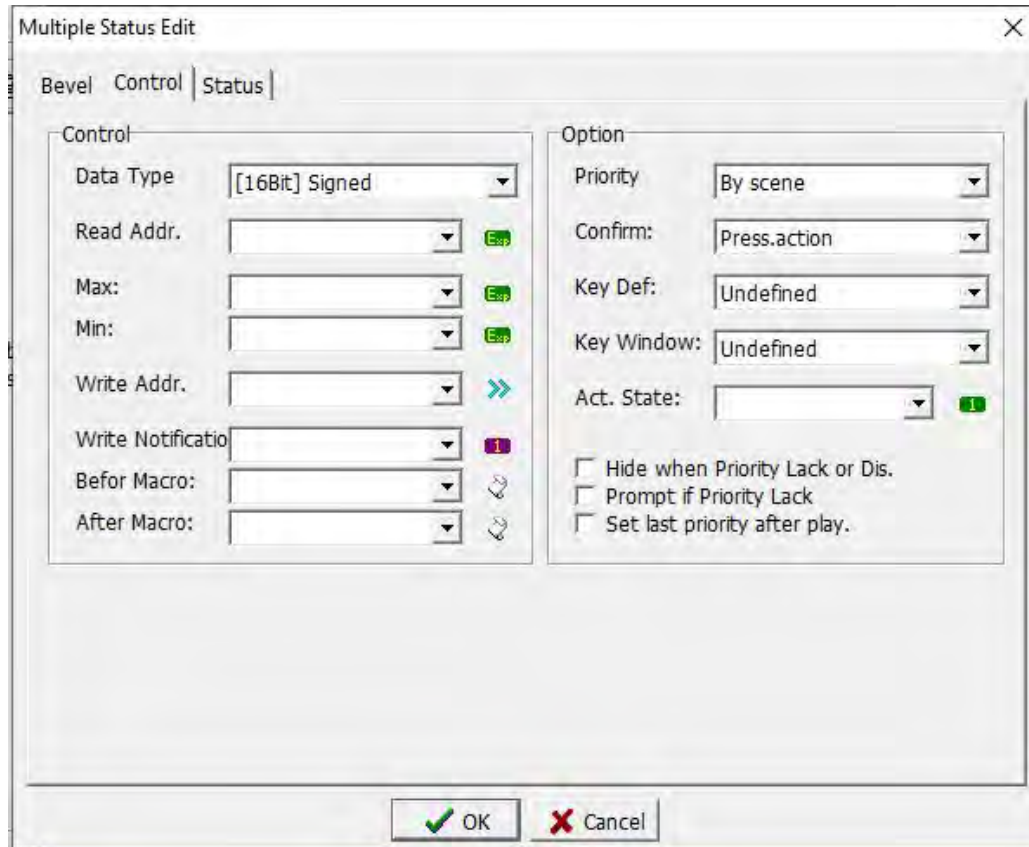

1. **Bevel:** refer to section 3.3.1
2. **Control:** as shown above, please refer to section 3.3.2. (Difference below)  
 Read position: Set the position of the variable to be read, and then read the value of that position.
3. **Status:** as shown above, please refer to section 3.3.2. (Difference below)

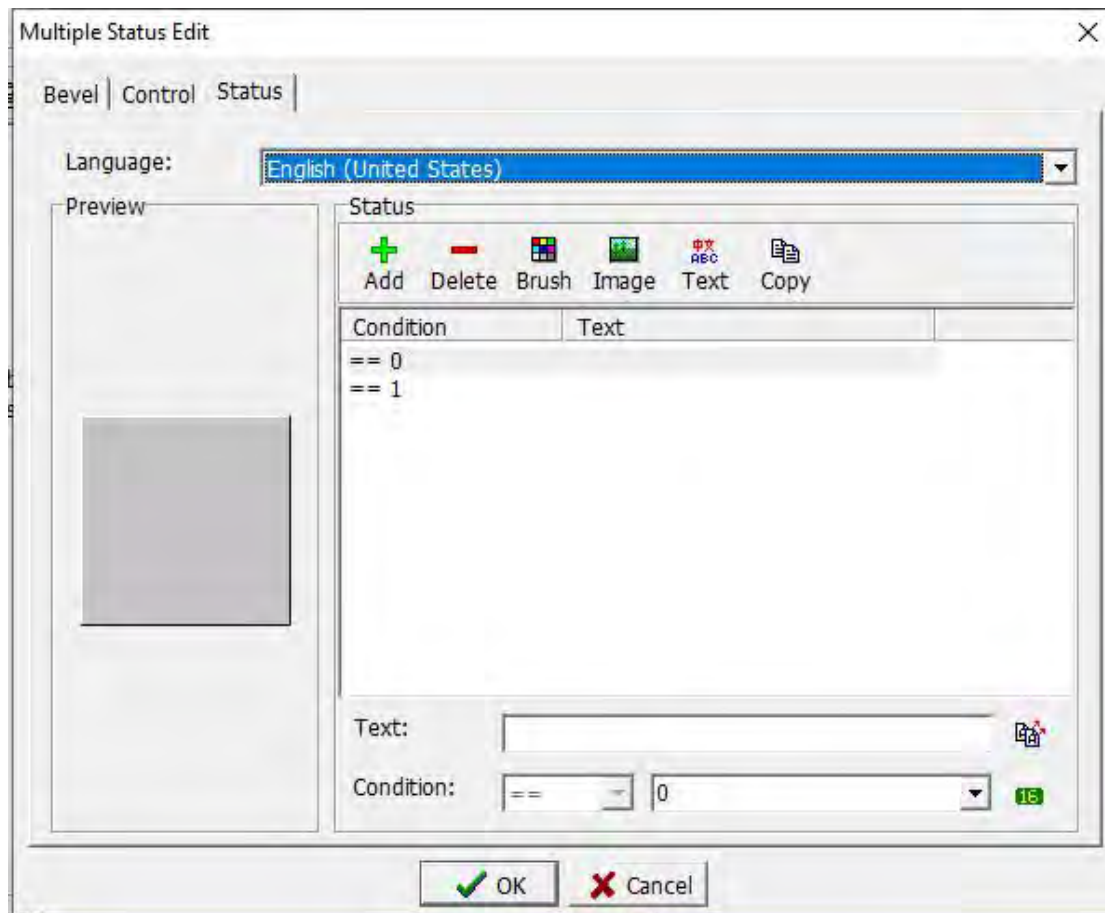

Conditional expression: Set the value of the conditional expression, that is, you can set different values to make the component display different states.

### 3.5.2 Numeric Entry

Click [Component]-> [Edit]-> [Numeric Entry] to display the value editing element on the editing screen. Right click or double click to enter the property setting page. The Numerical property setting dialog box is shown in the figure below.

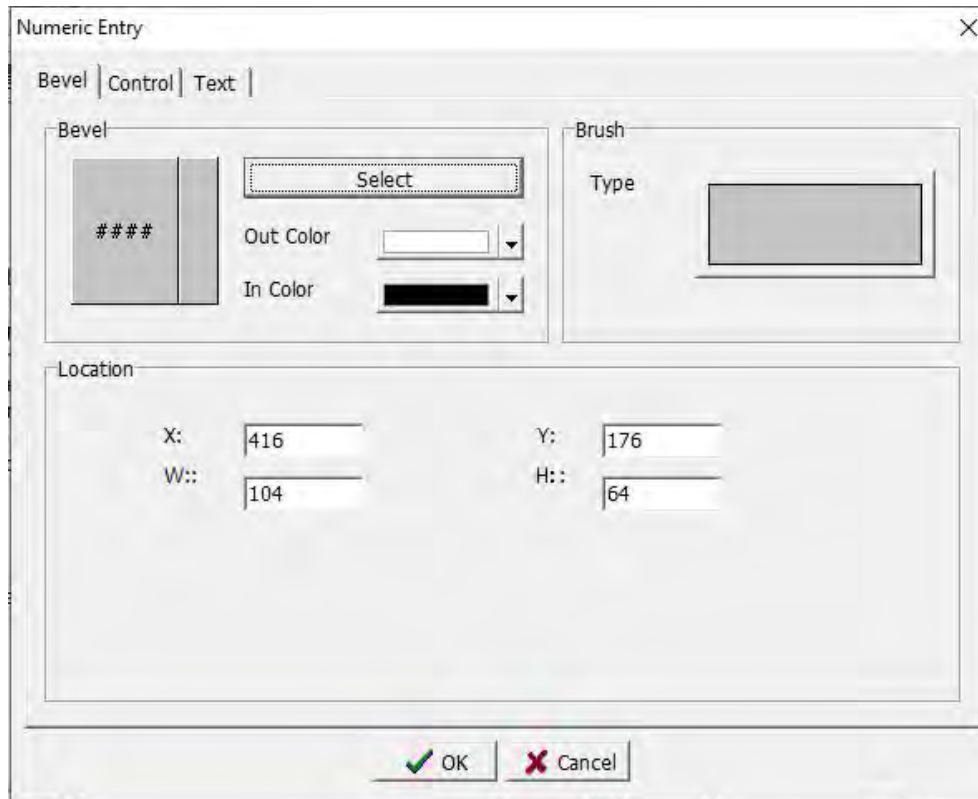

- 1. Bevel:** As shown above, refer to section 3.3.1.(Difference below)  
Select button: Click the select button to pop up the dialog box as below.

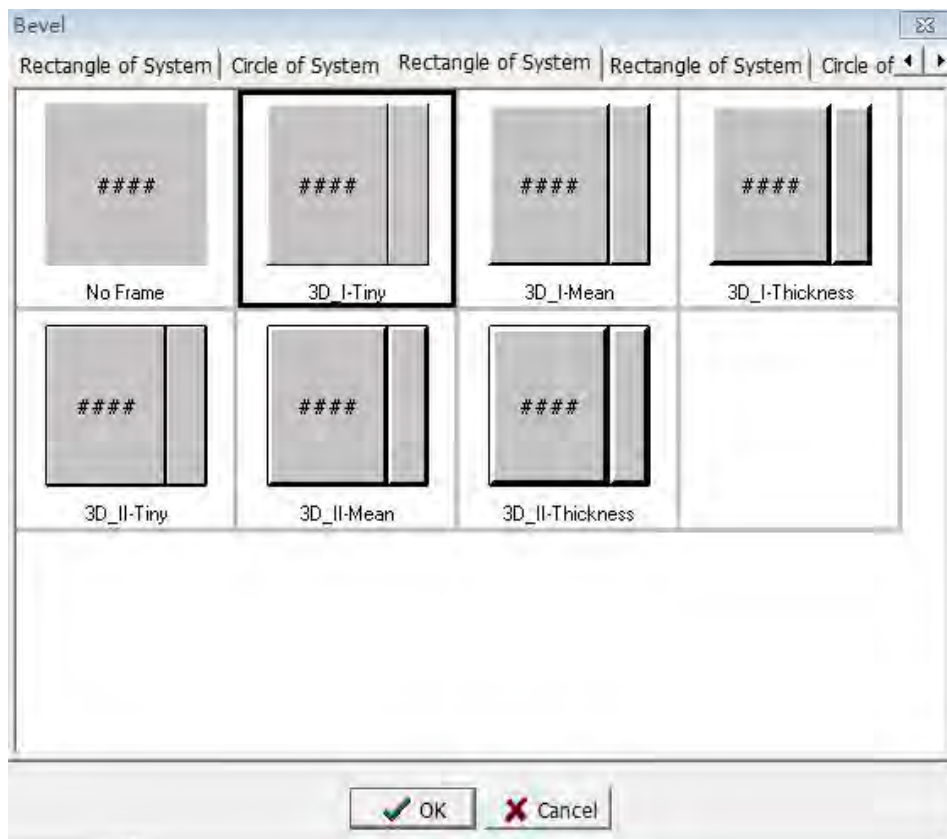

You can choose the shape of the editing component. There are 5pages

about 36 to choose .

## 2. Control: Page as below.

Refer to section 3.3.2. (Difference as below)

Read address: Set the position of the variable to be read, and then read the value of that position.

### Engineer Transfer

Offset: Set the offset value after entering numeric data.

Gain: Set the magnification value after inputting numerical data.

Auxiliary calculation: When the offset value and magnification value are not calculated, click this button to pop up the auxiliary calculation dialog box as shown in the figure below.

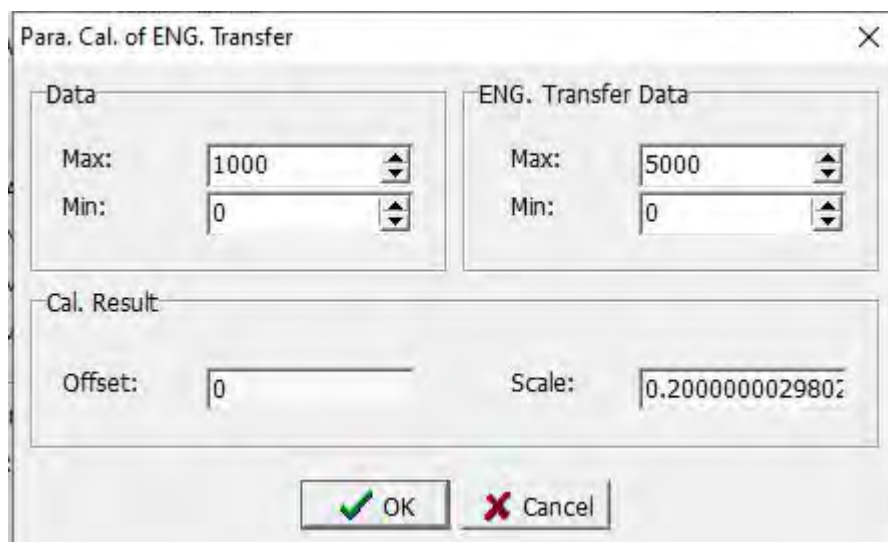

Parameter calculation of Eng. Transfer: Set the maximum and minimum values to read.

Eng. Transfer Data: Set the maximum and minimum values after reading position transfer data.

Cal. Result: The system automatically calculates the offset value and the magnification value according to the input variable value and the project converted value.

OK: Click this button to exit this setting dialog and display the calculation result at the corresponding position on the previous page.

Cancel: Click this button to exit this setting dialog without making any changes.

For example:

When the HMI communicates with the PLC, the analog value in the PLC needs to be read, but the digital value in the PLC is 0 ~ 4000, but the HMI needs the operator to see the temperature value of 0 ~ 50 °C. In this case, you can set the offset and magnification values in the engineering conversion data. Thus reducing the amount of calculation in the PLC.

Parameter calculation of Eng. Transfer set in the example above:



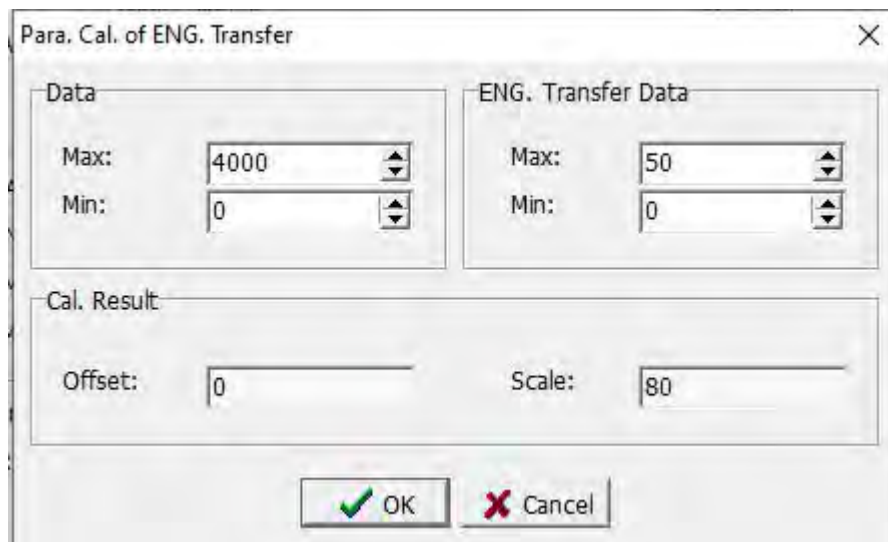

After clicking [OK], the properties of the numeric entry component are shown below:

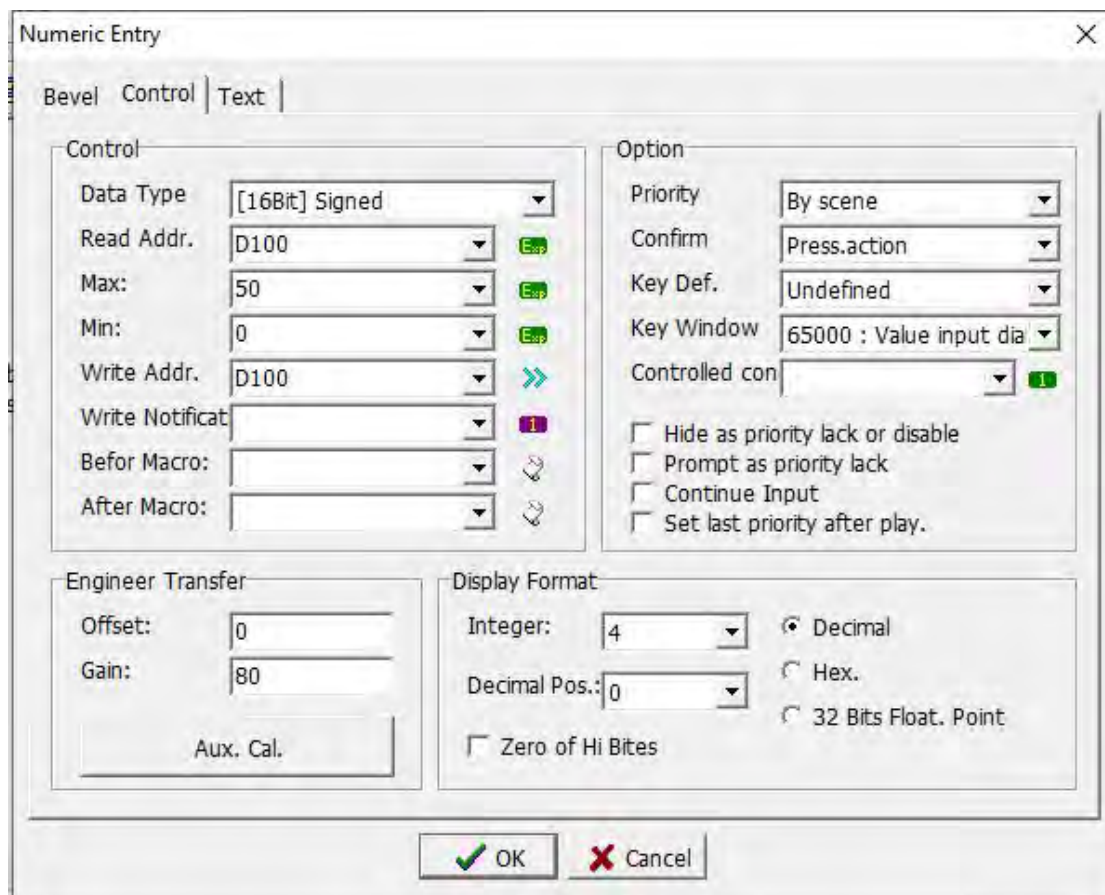

After setting, when the corresponding digital value is read in the PLC, the converted value is displayed in the HMI, as shown in the figure below

**First Screenshot:** Device D100 displays 25 °C. The configuration window shows a value of 2000. The bit table for D100 is:

Device	F	E	D	C	B	A	9	8	7	6	5	4	3	2	1	0
D100	0	0	0	0	0	1	1	1	1	0	1	0	0	0	0	0
D101	0	0	0	0	0	0	0	0	0	0	0	0	0	0	0	0

**Second Screenshot:** Device D100 displays 38 °C. The configuration window shows a value of 3000. The bit table for D100 is:

Device	F	E	D	C	B	A	9	8	7	6	5	4	3	2	1	0
D100	0	0	0	0	1	0	1	1	1	0	1	1	0	0	0	0
D101	0	0	0	0	0	0	0	0	0	0	0	0	0	0	0	0

Numeric Entry

**Control Section:**

- Data Type: [16Bit] Signed
- Read Addr.: D1
- Max: [Empty]
- Min: [Empty]
- Write Addr.: D1
- Write Notificat: [Empty]
- Befor Macro: [Empty]
- After Macro: [Empty]

**Option Section:**

- Priority: By scene
- Confirm: Press.action
- Key Def.: Undefined
- Key Window: 65000 : 数值输入对话框
- Controlled con: [Empty]
- Hide as priority lack or disable
- Prompt as priority lack
- Continue Input
- Set last priority after play.

**Engineer Transfer Section:**

- Offset: 5
- Gain: 1.0
- Aux. Cal.: [Empty]

**Display Format Section:**

- Integer: 4
- Decimal Pos.: 0
- Decimal
- Hex.
- 32 Bits Float. Point
- Zero of Hi Bites

If the value of D1 in the PLC is 20, the screen will display 15.

OK Cancel

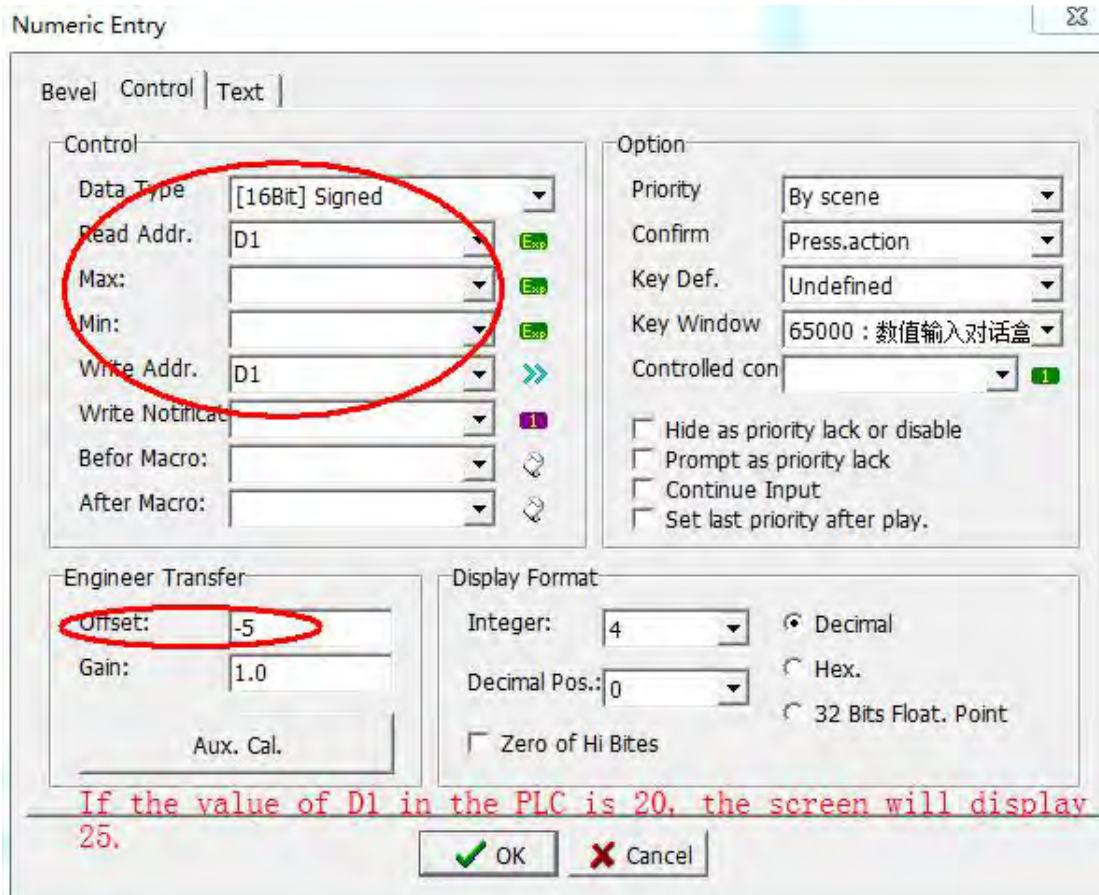

### 3.5.3 Text Entry

Click [Component]-> [Edit]-> [Text Entry] to display the value editing element on the editing screen. Right click or double click to enter the property setting page. The text entry property setting dialog box is shown in the figure below.

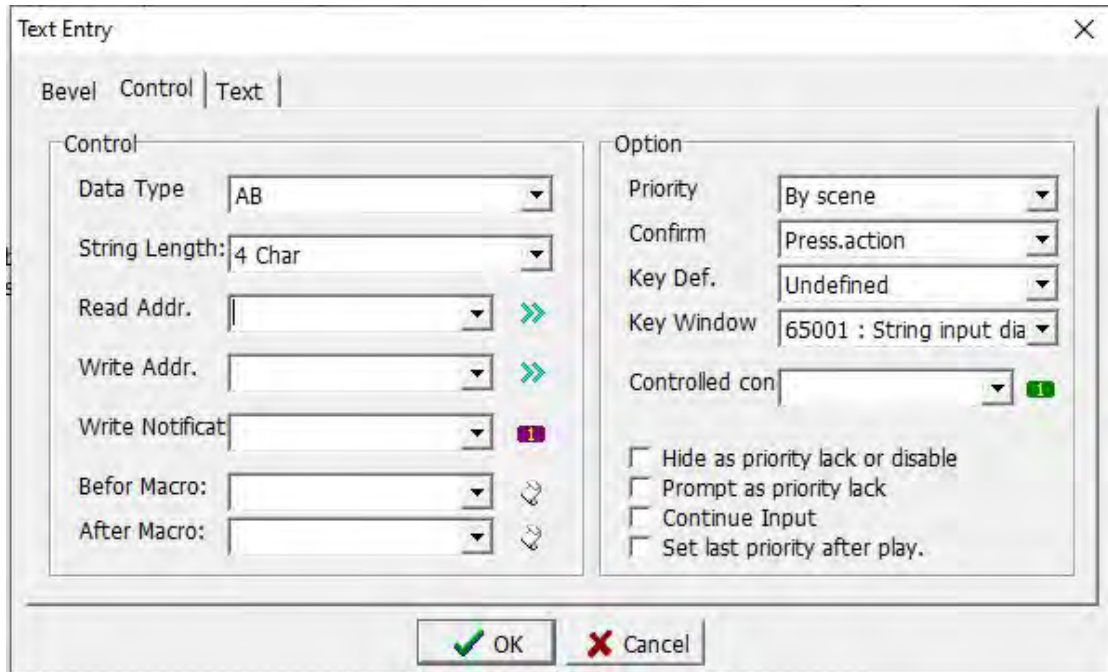

**1. Bevel:** refer to Chapter 3.3.1 and Chapter 3.5.2.

**2. Control:** The page is as shown above, please refer to section 3.3.2.(Differences as below)

Data Type: Select the format of the text string corresponding to the writing position

0. AB: the first word is written to the high-order bits of the variable, and the second word is written to the low-order bits of the variable.

1. BA: The second word is written to the high-order bits of the variable, and the first word is written to the low-order bits of the variable.

2. \_A: Each variable only stores one text in the low position.

3. A\_: Each variable only stores one text in the high position.

4 ~ 7, same as 0 ~ 3, But no text is displayed, only "\*" is displayed.

String Length: Set how many characters to display. It can display 1 ~ 32 characters.

**3. Text:** refer to section 3.4.2 .

### 3.5.4 Password Edit

Click [Component]-> [Edit]-> [Password Edit] to display the password editing element in the editing screen. Right click or double click to enter the property setting page. The password edit property setting dialog box is shown in the figure below.



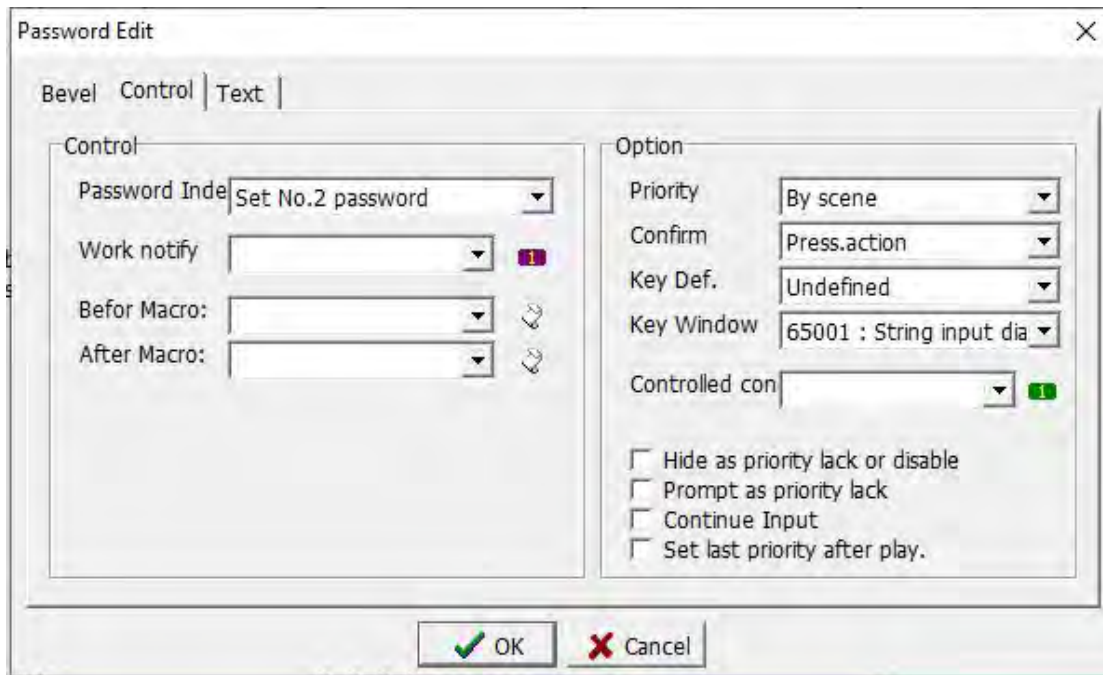

**1. Bevel:** refer to Chapter 3.3.1 and Chapter 3.5.2.

**2. Data:** The page is as shown above. (refer to section 3.3.2, Difference as below)

Password index: Set the second to eighth passwords. At this time, the keyboard window in the option section on the right needs to set the input screen as the password input dialog box, otherwise it cannot be entered.

**3. Text:** refer to section 3.4.2.

After setting the parameters, click this component during execution, and the previously edited input screen will appear. After the input is completed, the password setting operation is completed.

### 3.5.5 Track Bar

Using the slider element, you can use the adjustment knob to quickly set the value of the element.

Click [Component]-> [Edit]-> [Track Bar] to display the slider component in the edit screen. Right click or double click to enter the property setting page. The slider property setting dialog box is shown below.



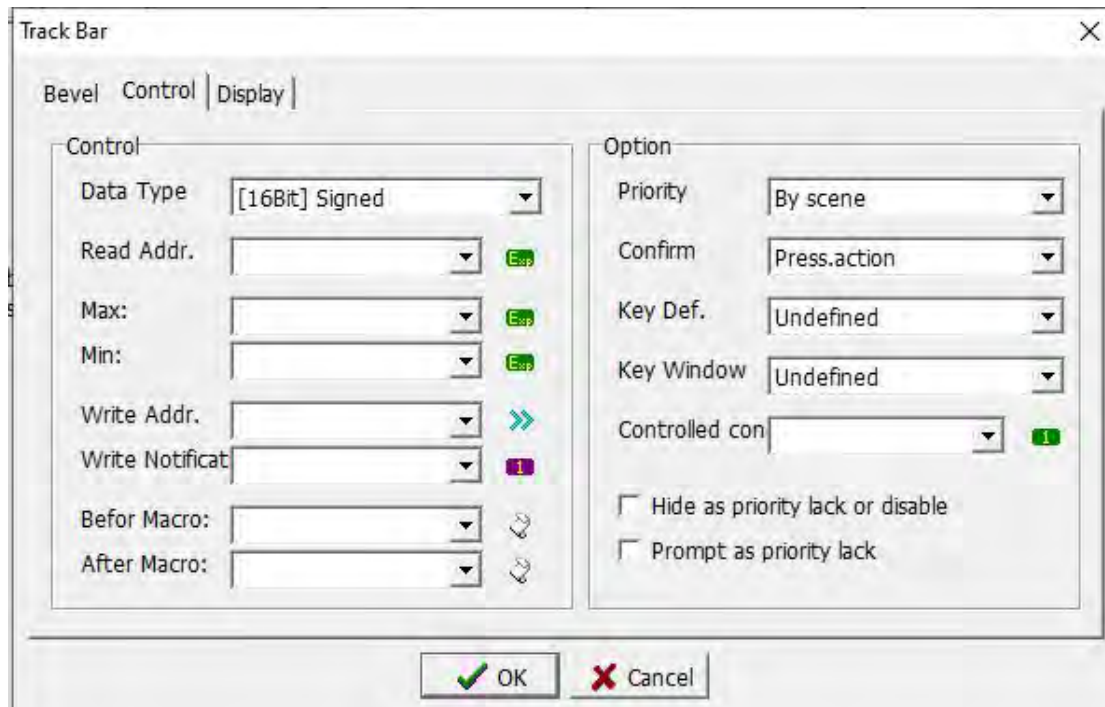

1. **Bevel:** refer to section 3.3.1.
2. **Control:** refer to Section 3.3.2.
3. **Display:** The page is as shown above.

Display form: Set the position display mode of the component display scale.

Scale form: Set the display form of the scale.

Scale color: Set the display color of the scale.

Select Bevel: Set the form of selecting the internal border display.

Adj. Key Sel.: Set the display mode of the selection adjustment button.

Scale Numbers: Set the number of scales to be displayed. The setting range is 1 ~ 100.

Scale Length: Set the length of the scale line, the setting range is 3 ~ 12.

Outer frame color: Set the outer frame color of the inner frame and the adjustment button separately.

Inner frame color: Set the inner frame color of the inner frame and the adjustment button respectively.

Brush Style: Set the brush form of the inner border and the adjustment button separately.

### 3.5.6 Scroll bar

Quickly set the value of the component. In addition to using the slider component, you can also use the scroll bar.

Click [Component]-> [Edit]-> [Scroll Bar] to display the scroll bar component in the edit screen. Right click or double click to enter the property setting page. The scroll bar property setting dialog box is shown below.

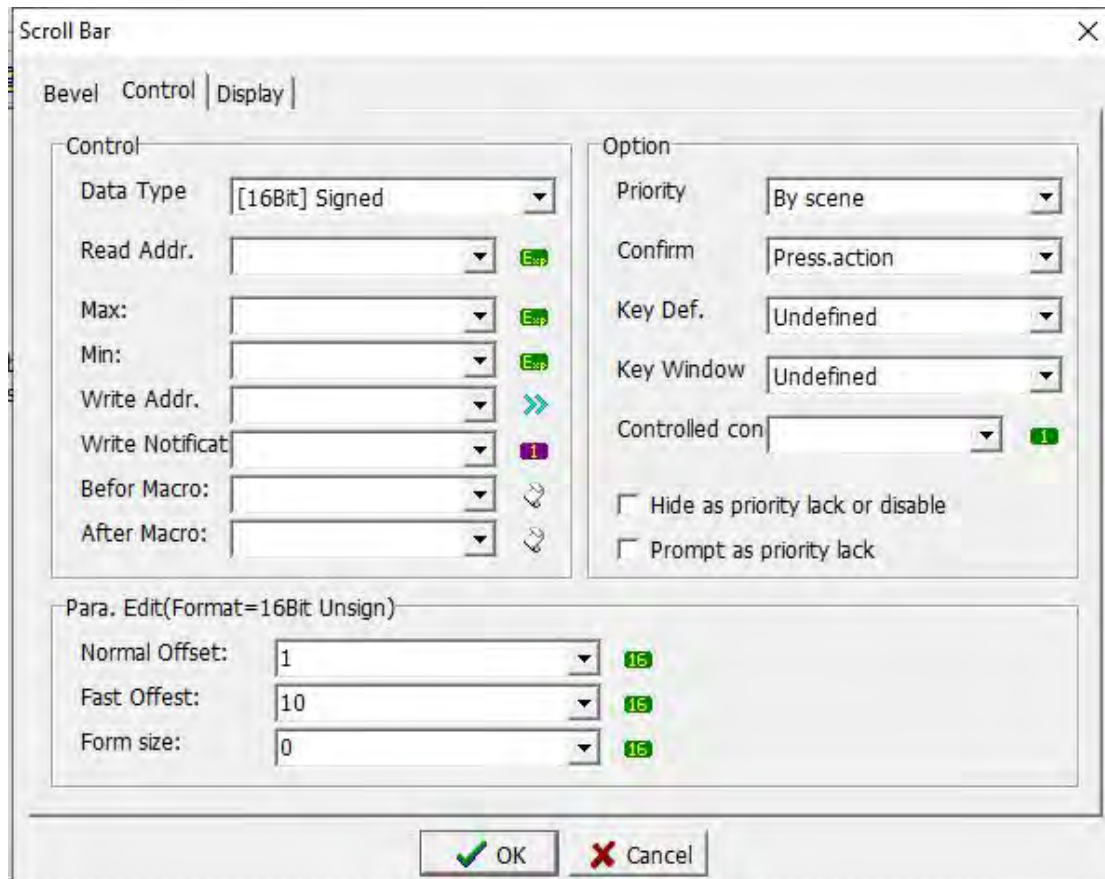

**1. Bevel:** refer to section 3.3.1.

**2. Control:** The page is as shown above.(refer to section 3.3.2,differences below)

Para. Edit(Format=16Bit Unsign)

Normal offset: Set the general offset value, that is, the data that moves every time you click the left and right arrows of the scroll bar.

Fast offset: Set the value of fast movement, that is, the data that moves every time the scroll bar is clicked once.

Form size: Set the width of the slider.

**Note:** The setting in the parameter editing column is only effective when the data format is set to 16-bit signed / unsigned number.

**3. Display:** refer to section 3.5.5.

### 3.5.7 List box

In addition to the scroll bars and sliders described in the previous sections, you can also use list boxes to quickly change the data of register elements.

Click [Component]-> [Edit]-> [List Box] to display the list box component in the edit screen. Right click or double click to enter the property setting page. The list box properties setting dialog box is shown in the figure below.

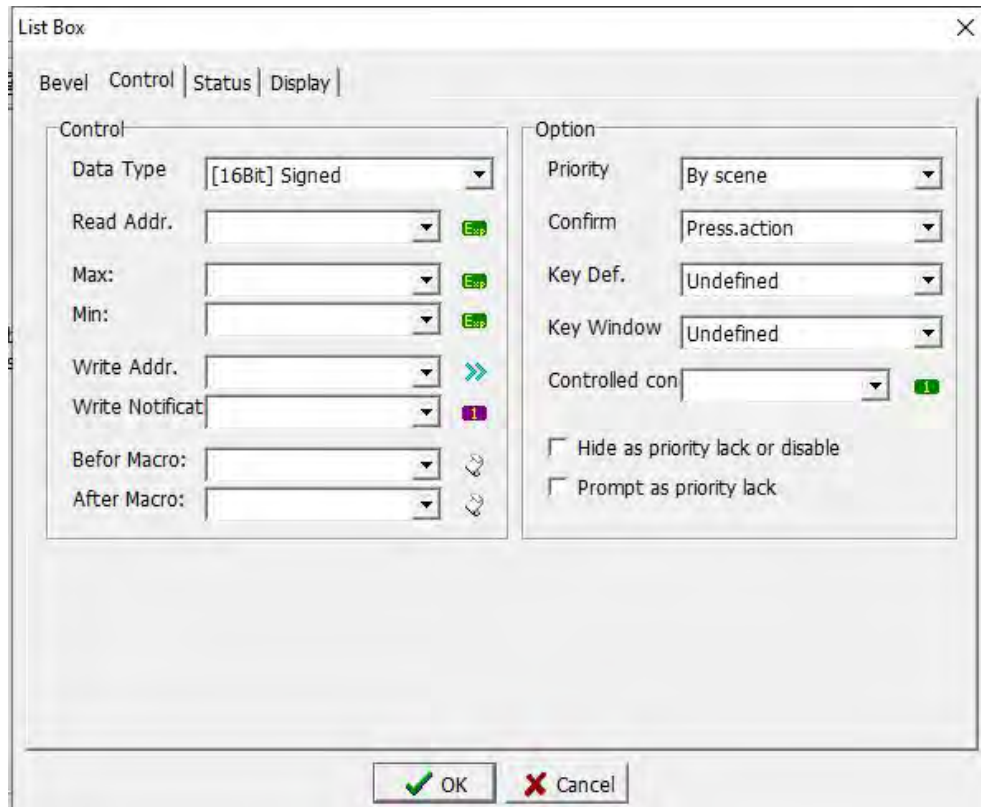

1. Bevel: refer to section 3.3.1.
2. Data: refer to Section 3.3.2.
3. Status: refer to Section 3.3.2.
4. Display: refer to section 3.5.5.

## Chapter 4 Project management

### 4.1 Screen management

The [Screen] allows us to quickly understand all the current pictures. Add, edit, delete, preview all pictures. For details of this chapter, please refer to 2.4.1 Scene. After we create a new file, we can see the screen section shown in the figure below, which is divided into two parts: screen and preview.

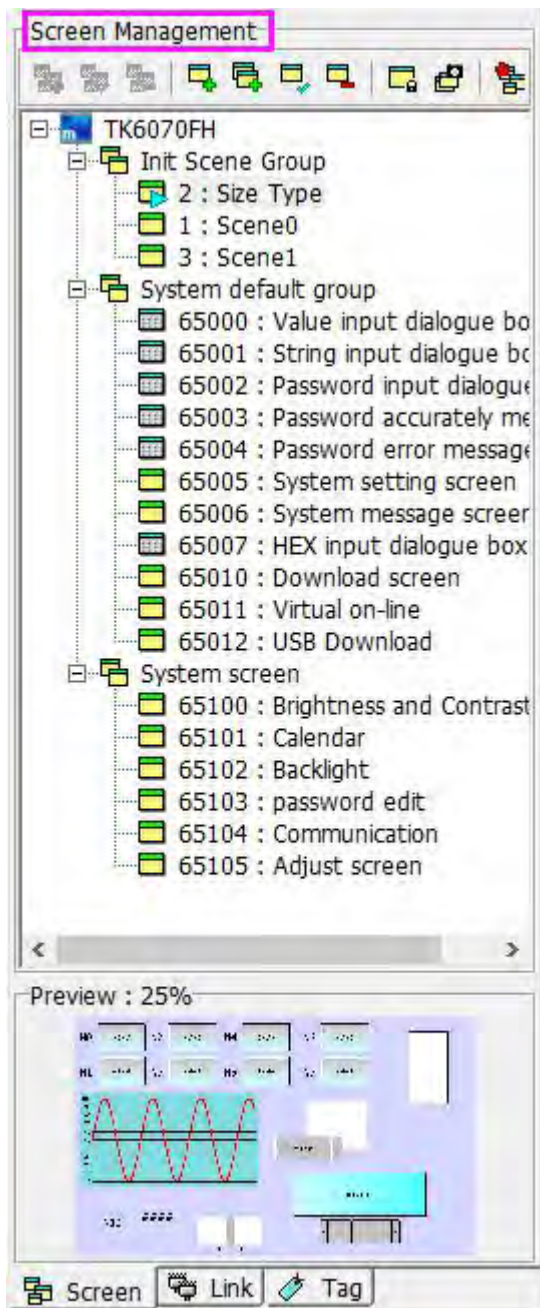

#### Screen management

Use a tree structure to represent the relationship between each group. Example: Only the scenes belonging to this group will be displayed under the

initial screen group.

[TK6070FH]: indicates the HMI model set when creating a new file.

[Init Screen Group]: The system's preset starting screen group is convenient for us to edit the screen and can be clearly classified. When the screen is edited to a considerable degree, the group function becomes more important. You can also create a group according to your needs. Right-click the TK6070FH or start screen group, and select [New Screen Group] in the pop-up scene. Set the group name and permissions for this group. For example, the system in the figure above Preset group.

[Start Screen]: Under each group, you can create a screen belonging to the group, which is convenient for us to edit and browse, and can quickly know the current relationship between all the scenes and groups.

### **Preview**

When a certain picture is selected, the screen preview will display the preview graphic of the selected picture, and the size of the preview picture size can also be adjusted. Therefore, when there are many scenes, you can directly click the screen in the screen management, and you can see the preview graphic of the selected screen in the screen preview.

#### **4.1.1 Dialog box screen**

The purpose of the dialog box is that when we press a certain function button, such as when confirming or canceling, in order to avoid human negligence, pressing the button first causes loss of important data, so the dialog box window is set to prompt when the button is pressed to ask whether OK to avoid the loss caused by accidentally pressing the button.

The dialog box made in the case is only a basic form. Of course, users can make dialog boxes of different styles according to their own ideas or needs. After reading this chapter, Hope it can give you useful information.

### **Add, edit, delete dialog boxes**

Click [Project]-> [Screen]-> [Add Screen],



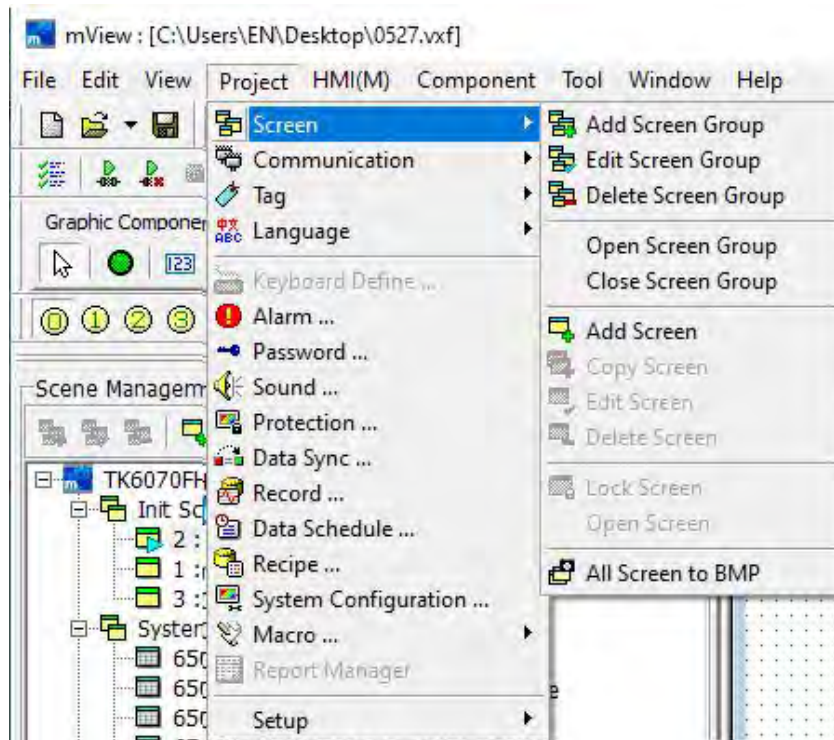

or right-click [Init Screen Group] in the Windows management, as shown in the figure below.

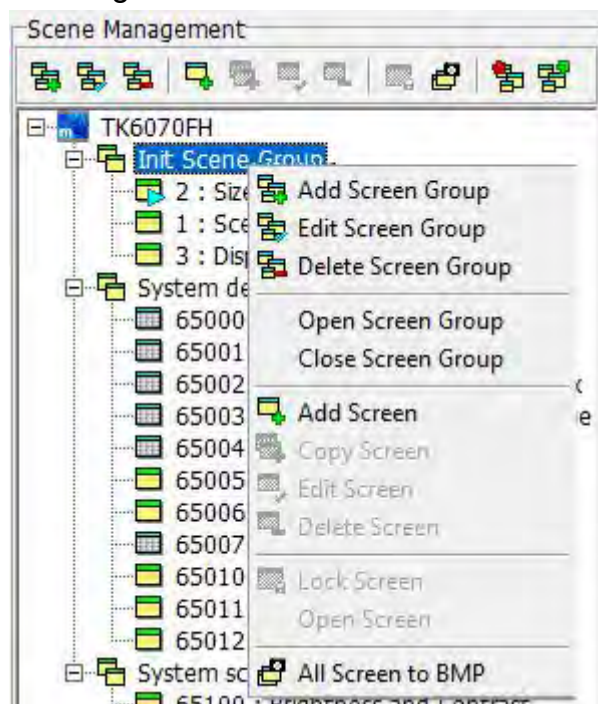

After selecting [Add Screen], a window for adding a screen will pop up as shown in the figure below. Select the dialog box in the [Screen Type] . For other settings, refer to section 2.4.1. Click the [OK] button to add a dialog box window.

The screenshot shows the 'Add Screen' dialog box with the following settings:

- Tab: Normal
- Screen Data:
  - Name: Screen2
  - Num.: 4
  - Type: Normal Screen
  - Security: By scene group
  - Inherit: Undefined
  - BG Color: (empty)
  - Description: (empty)
  - Position: Center
- Auto Switch:
  - Delay Time: 0 Sec
  - Jump to: Undefined
  - Note: Stop function of Auto. switch screen as Delay Time set zero, The Delay Time rang is 0 .. 32767.
- Macro:
  - Screen OPEN Macro
  - Screen CLOSE Macro
  - Screen CYCLE Macro
  - CYCLE Macro Interval: 0.5Sec

When editing or deleting a screen, you can select the screen to be edited or deleted, and then click [Project]-> [Screen], or right-click on the selected screen to select the edit or delete screen. The settings for the edit screen are the same as those for adding new screen.

#### 4.1.2 Case of dialogue box

After adding the dialog box window, you can start editing the dialog box screen you need, as shown below. The examples given here are examples of extending multiple languages and components. Please refer to Chapter 5 "Language Management".

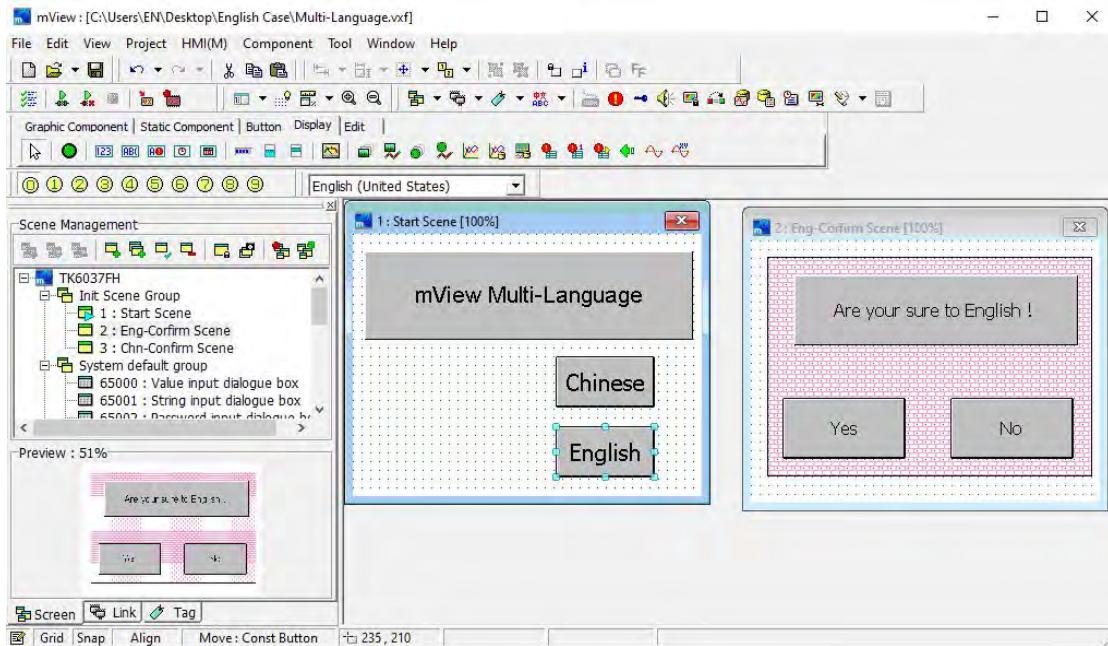

Step 1. Add new screen and set the screen property as dialogue box. As shown in picture 2 above , the name is set to [Confirmation dialogue box].

Step 2. Place two key buttons on the screen, and set them to [Confirm] and [Cancel].

Step 3. Set the properties of the [Confirm] button, refer to section 3.3.5. The settings of the data page are shown in the figure below.

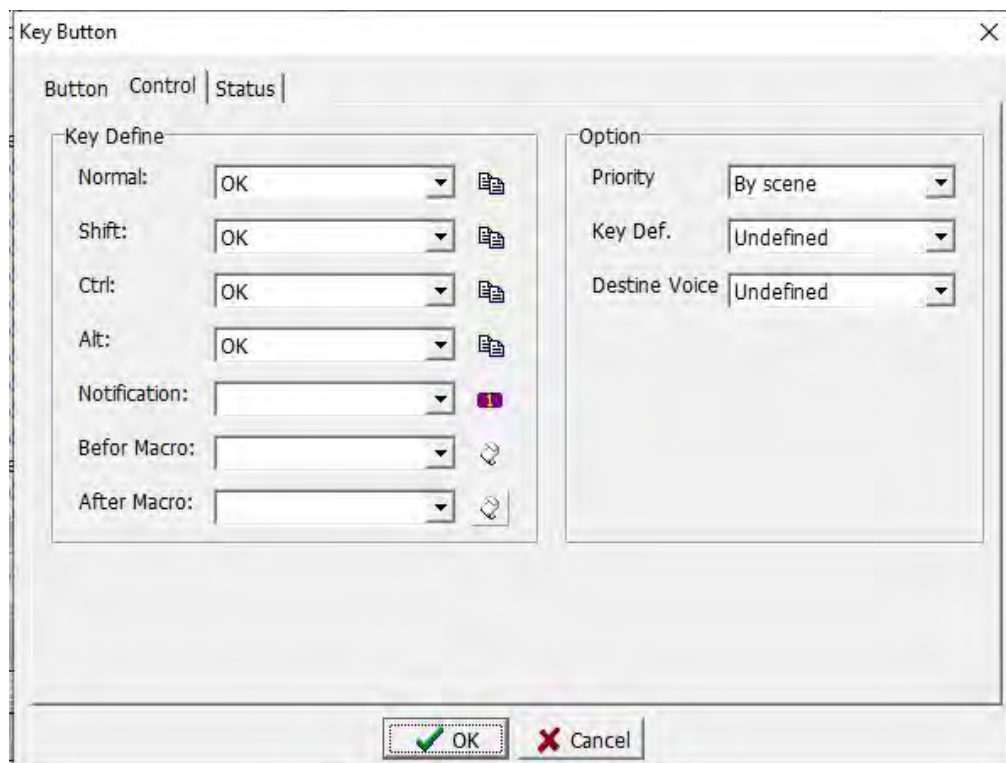

Normal: The action to be performed when this button is pressed.

Shift: The action to be performed when the [Shift] key and the button are all pressed.

Ctrl : The action to be performed when the [Ctrl] key and the button are all pressed.

Alt: The action to be performed when the [Alt] key and the button are all pressed.

In the definition of the keys in the figure above, there are too many functions to choose from. In this Case, we take two examples to explain. The OK button is used as the OK key, so select [OK] in all four fields columns.

Step 4. Select the [Status] page to set the parameters of this page. Because the main function of this button is to use it as the OK key, all the text in the 0 ~ 3 index value is entered Confirm. As shown below.

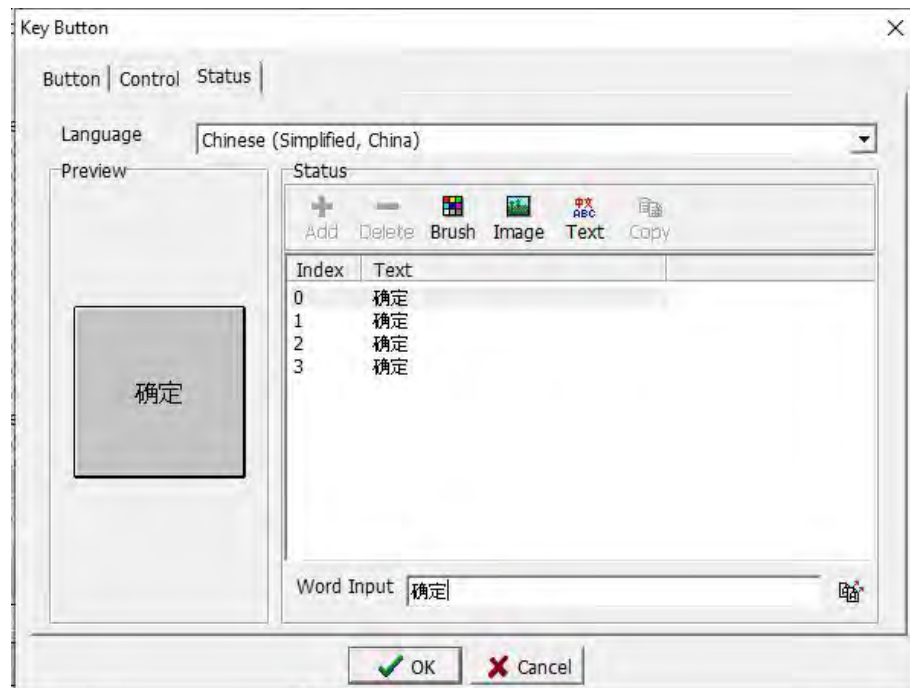

Step 5. Set the Other language text. Otherwise, the language text cannot be displayed normally. As shown below.



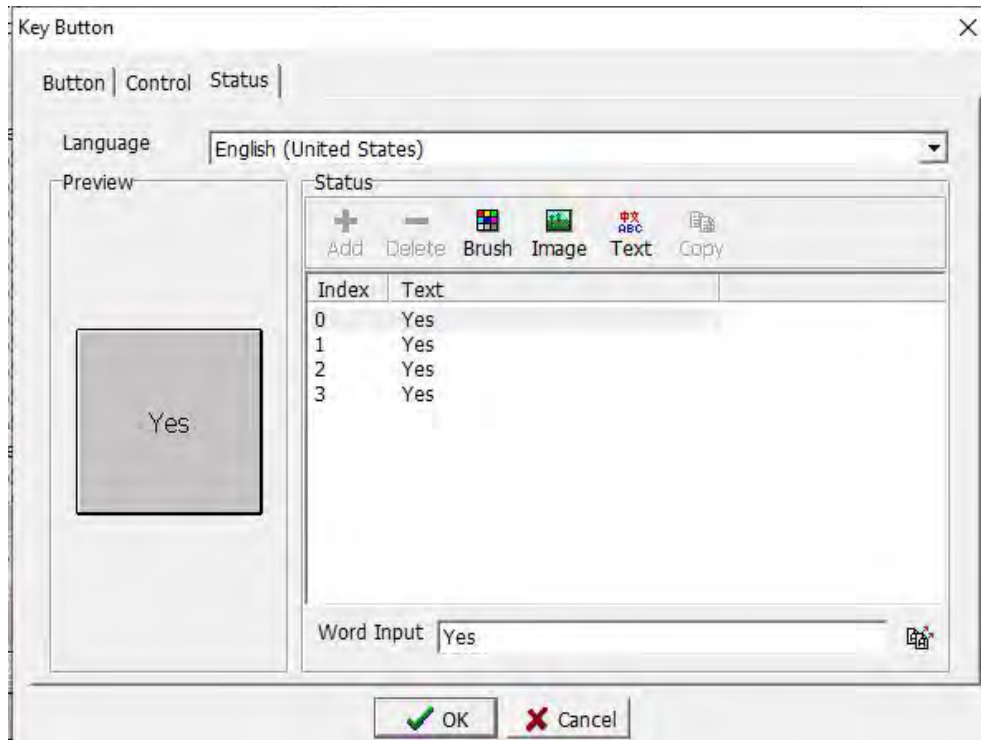

Step 6. Set another key button as the cancel key. For the method, refer to Step 3, Step 4, and Step 5.

Step 7. After setting the properties of the two buttons, the Chinese confirmation dialog box is completed.

As shown below.

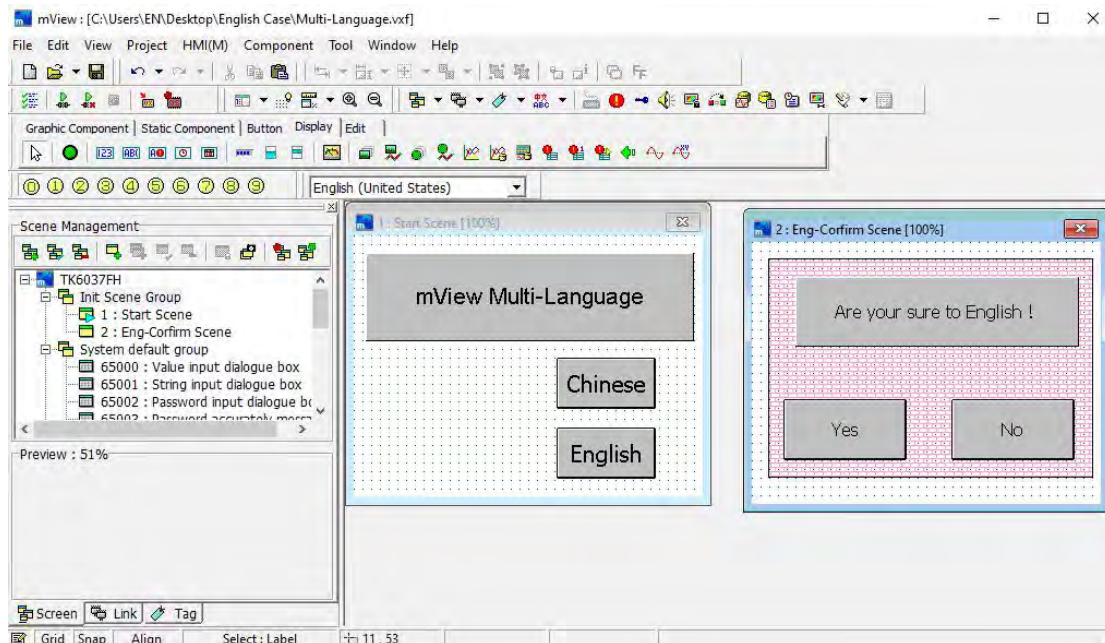

Step 8. When we press the two buttons [Chinese] and [English] in the start screen, the dialog box screen must appear for confirmation, so two dialog boxes must be created. Here you can right-click [Confirm Dialog Box] in the screen management and click [Copy Screen] in the pop-up shortcut menu. Modify the screen properties, as shown below



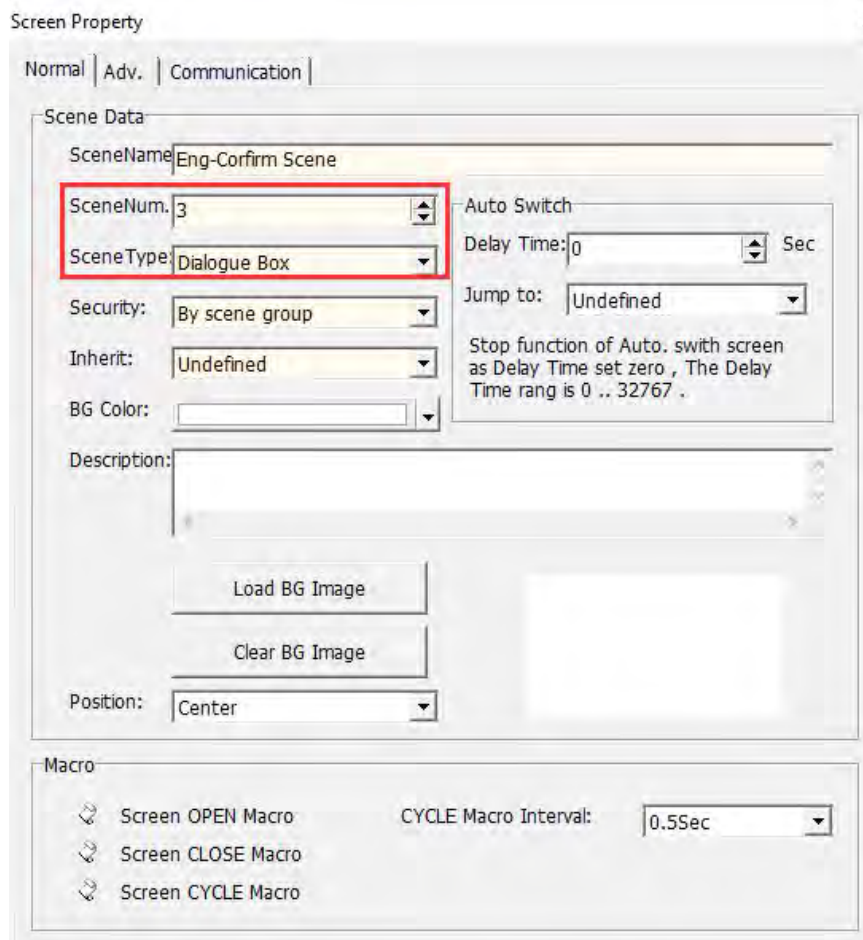
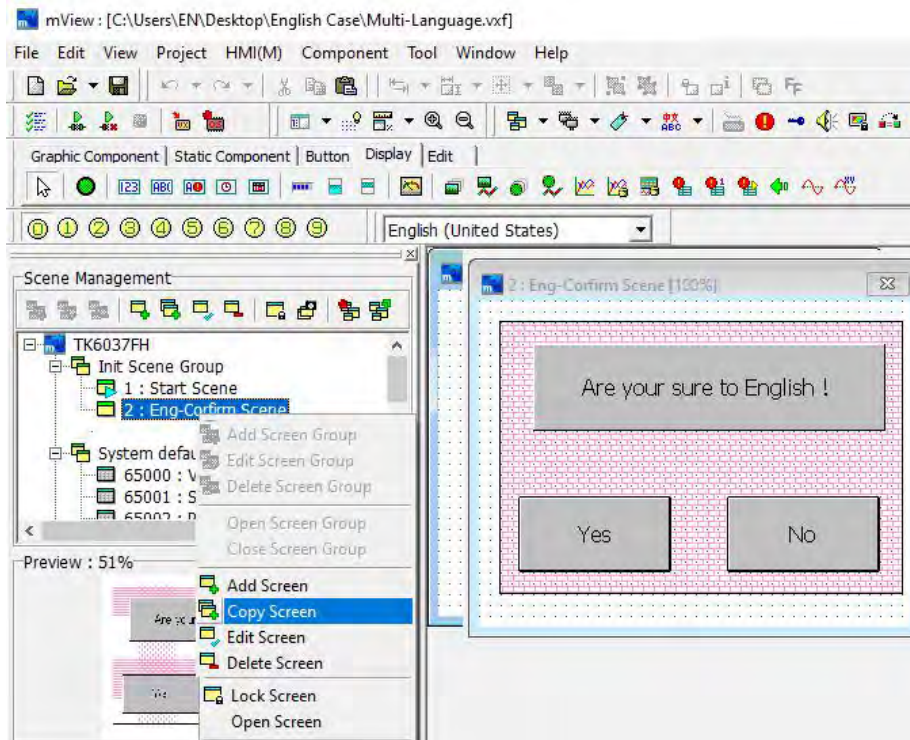

Step 9. Click the [Confirm] button in the screen properties to successfully add a new dialog box screen. After modifying the attributes of the components in the

new screen, the project is shown in the figure below.

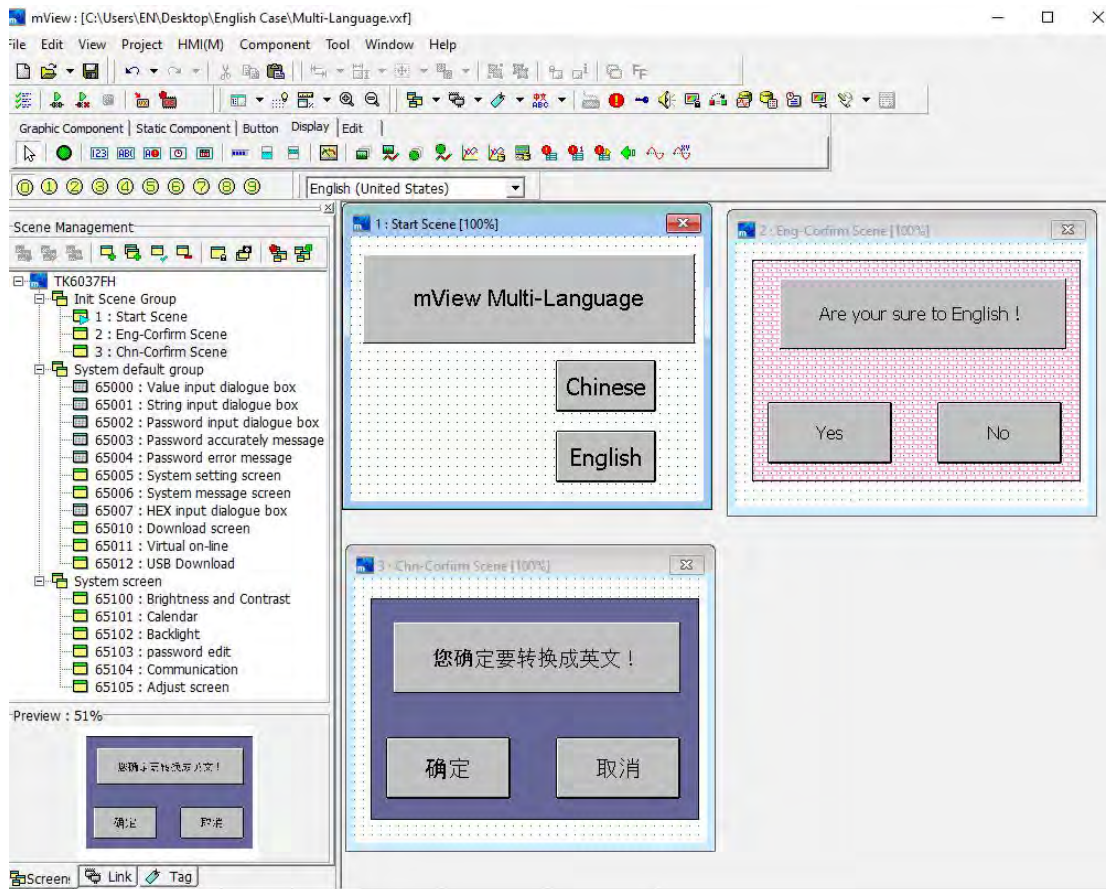

Step 10. In the initial screen, modify the properties of the [Chinese] button component as shown in the figure below. After completing the modification, click the [Confirm] button to save the settings.

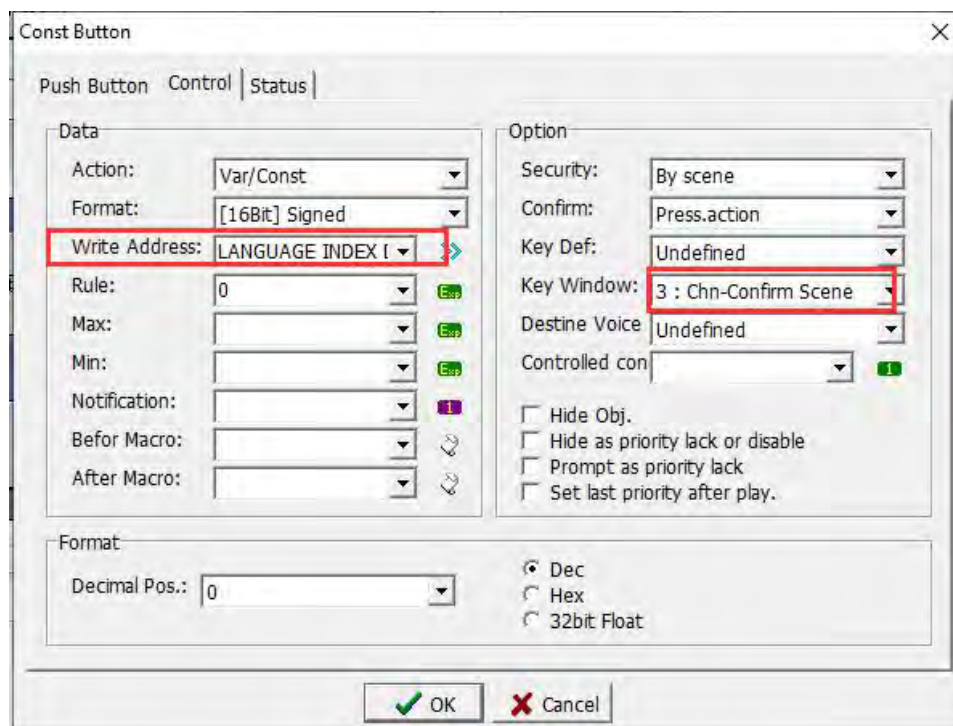

Step 11. In the initial screen, modify the properties of the [English] button component as shown in the figure below. After completing the modification, click the [Confirm] button to save the settings.

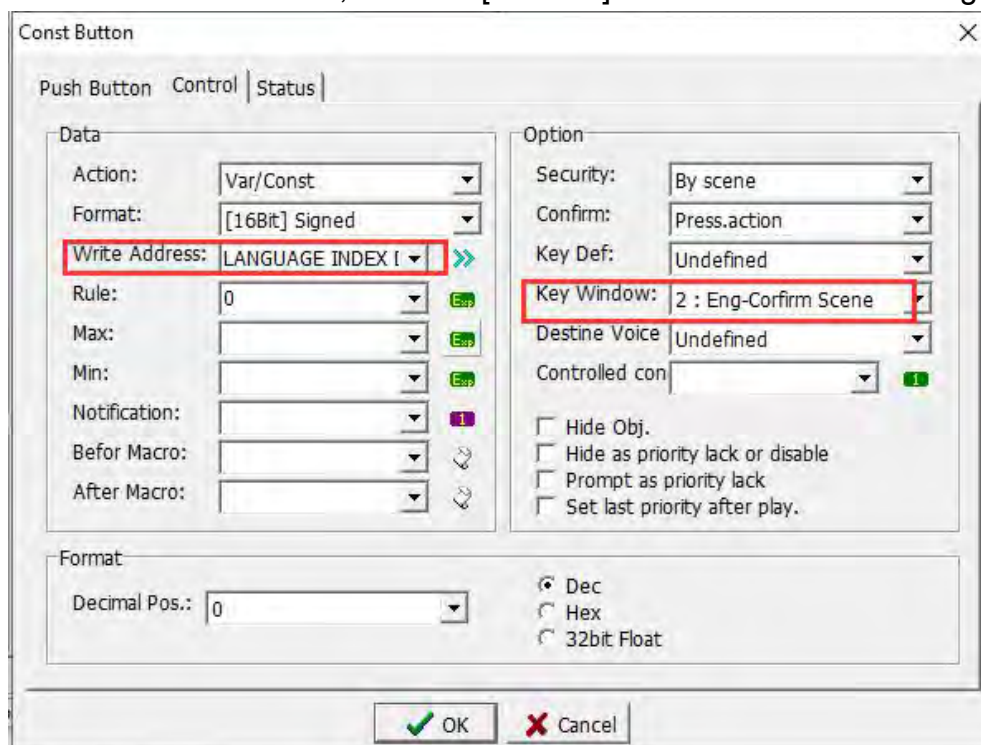

Step 12. Complete all design operations as above. The execution test screen is shown below.

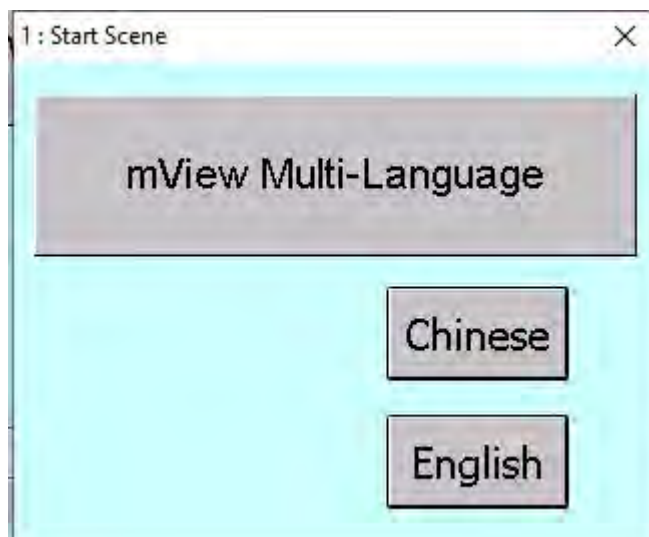

When the [Chinese] button is pressed, a confirmation dialog box appears as shown below.



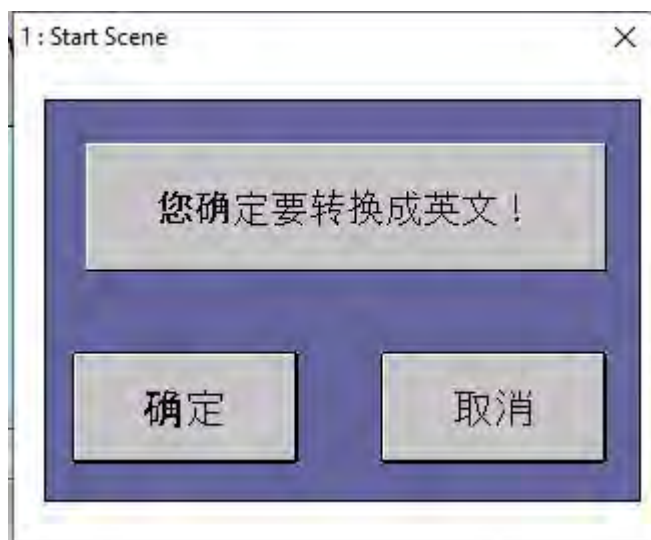

When the [English] button is pressed, a confirmation dialog box appears as shown below.

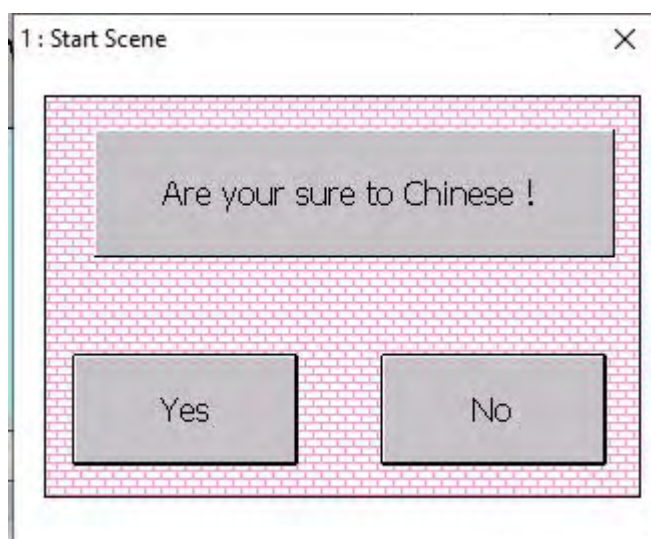

In this way, we can apply this case to other same functions, so as to avoid the situation where the button is accidentally pressed.

## 4.2 Link management

When you select Link management, you can see a tree structure diagram as shown in the figure below. You can quickly know which communication protocol and how many controllers are currently set in COM1 and COM2. You can select the communication protocol or controller by using the mouse. After pressing the right mouse button, you can quickly create, edit, and delete communication protocols or controllers to improve the timeliness of Link management operations. It is also easy to create, edit, and delete communication protocols or controllers.

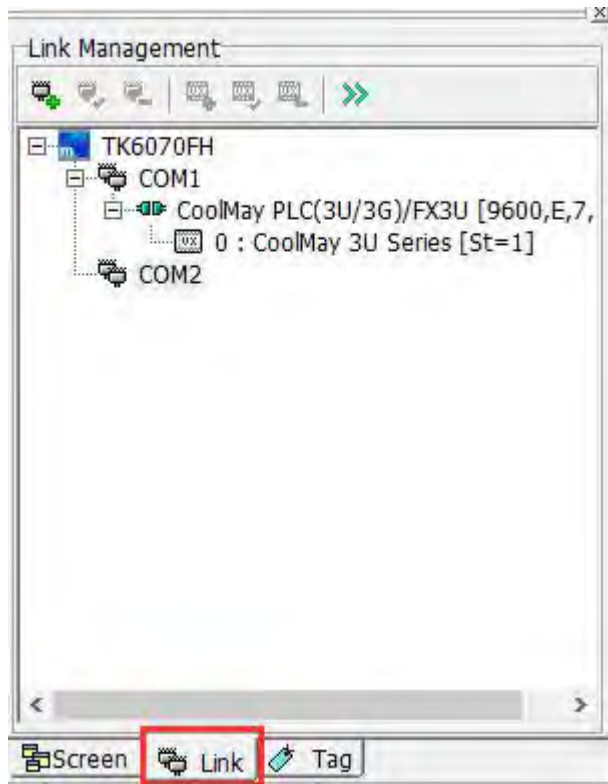

【TK6070FH】 : Indicates the HMI model set when creating a new file.

【COM1】 : Set the communication protocol that COM1 on the computer belongs to. After clicking, you can quickly create, edit, and delete communication protocols, but only one communication protocol can be set for a serial port.

【COM2】 : Set the communication protocol that COM2 on the computer belongs to. After clicking, you can quickly create, edit, and delete communication protocols, but only one communication protocol can be set for a serial port.

【Controller】 : Set the controller to which the communication protocol belongs in this serial port. You can set multiple controllers, but the station number and ID must be unique (for details, refer to section 4.2.1).

Right-click on any serial port and select [Add Protocol] to pop up the New Communication Protocol window. As shown in the figure below, select the communication protocol you want to use.



Protocol: CoolMay PLC(3U/3G)/FX3U

Controller:

Company	Model	Des...
CoolMay	CoolMay 3U Series	PLC

Port: Auto Detect(RS232/RS422/RS485)

Baud Rate: 9600      Data Bit: 7Bits

Parity: Even      Stop Bit: 1Bit

Delay: 0ms      TimeOut: 1sec

Multi-Station Smart Link      Retry Count: Timeout, Repeat

OK Cancel

Protocol: Use the drop-down options to select the protocol to be used.

Controller: Displays the manufacturer and model selected by the communication protocol.

Electrical: Four options for selection, automatic identification, RS232, RS422, RS485.

Baud Rate: from 150 to 115200 speeds, which can be selected.

Parity: [None], [Odd parity], [Even parity], [Mark], [Space].

Data bit: [5], [6], [7], [8].

Stop bit: [1 bit], [2 bit].

Delay: no delay, 10ms delay to 5000ms delay, optional.

Timeout: [0.1], [0.2], [0.5], [1], [1.5], [2], [3], [5], [10] a total of 9 options.

Retry Count: Set the numbers of re-transmissions when the communication is unsuccessful.

Multi-Station Smart Link: Select this function flag

Click the [OK] button to complete the setting of the communication protocol. The [Add Controller] pops up as shown in the figure below. You need to select the controller model you want to operate.

Add Controller X

Controller

ID:

Station:

Controller:

Company	Model	Description
CoolMay	CoolMay 3U Series	PLC

Description:

ID: The ID number of the controller.

Station : the station number of the controller, that is, the ID number of the PLC,

Controller: Display the selected manufacturer, model, description, etc.

Description: Enter a description or help for this controller.

#### 4.2.1 ID and station number

The station number (HMI station number) in the HMI unit setting is the ID (PLC ID) corresponding to the connected controller, and the ID (HMI ID) set by the human machine is the corresponding controller in the software setting. For the setting of the station number, COM1 and COM2 of the HMI are independent. Therefore, COM1 and COM2 can be set to connect the controller with the same station number, but for the setting of ID, each HMI cannot be repeated. Because the ID describes that this controller is which controller connected to HMI unit, as shown below.

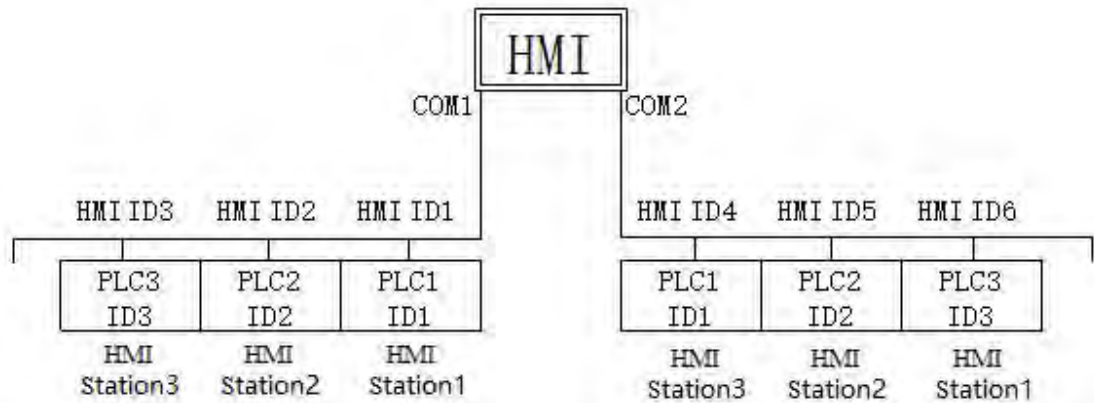

### 4.3 Tag management

Because there are many types of controller models, and the numbers of contacts and registers of communication protocols defined by different manufacturers are not the same, in order to facilitate the memorization of the contact or register numbers, the software design uses label management to increase readability.

For example, when creating a new label, we replaced the X1 contact with the name [test]. After the new construction is completed, as long as the component needs to use X1, type [test] in the write position or read position or click the drop-down menu to select [test], then the system will treat [test] as it is X1. In this way, each contact and register can be set with a convenient and easier name instead of the name of the contact and register on the original communication protocol.

#### 4.3.1 Tag management case

Step 1. Click [Project]-> [Tag]-> [Add Tag Group], as shown in the figure below. Using label classification can make labels more detailed, and it can be more convenient and quicker to use.

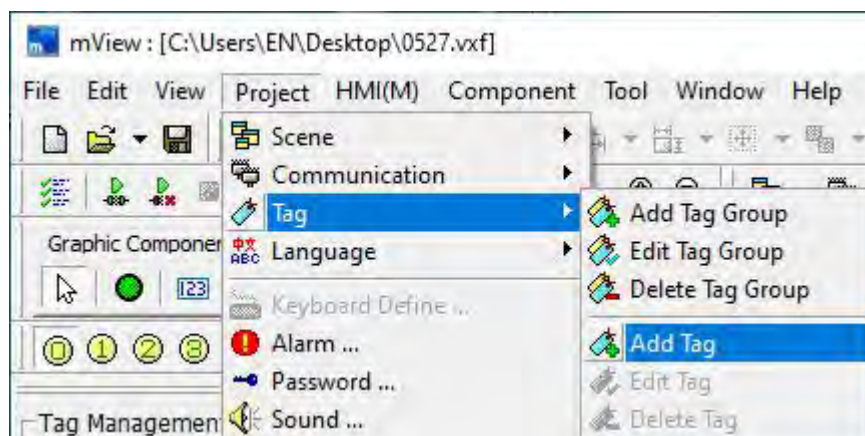

Step 2. In the pop-up “Add Tag Group” dialog box, set the name of the newly added tag classification, as shown in the following figure.

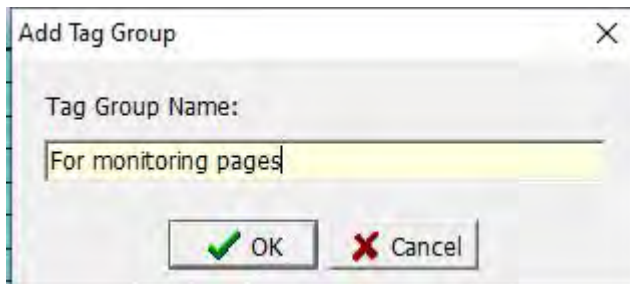

Step 3. Click the [OK] button to add a new tag group. At this time, you need to click [Project]-> [Tag ]-> [Add Tag] to pop up the dialog box for adding labels, as shown in the figure below.

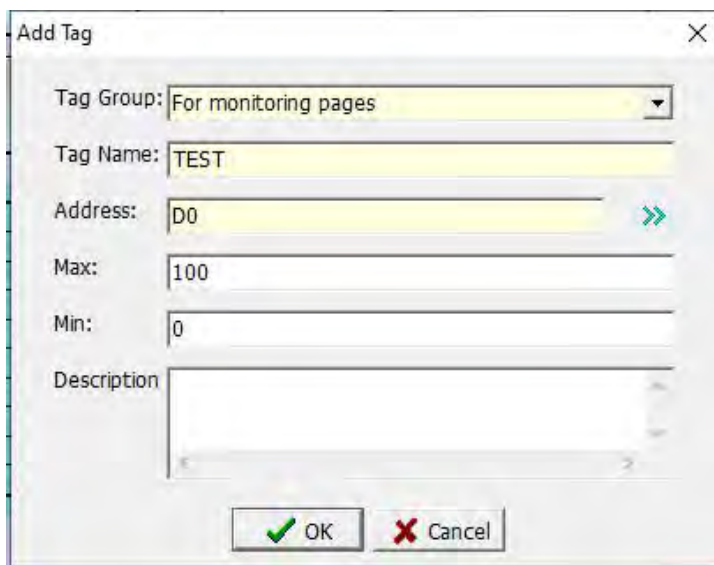

Set the content of each parameter, refer to section 2.4.3.

Note: If you do not need to subdivide the label classification, you can omit step 1 and step 2. When you add a new label, start directly from step 3.

Step 4. After clicking [OK] in step 3, the "For monitoring pages" tag will be added with a "TEST" tab, as shown below:

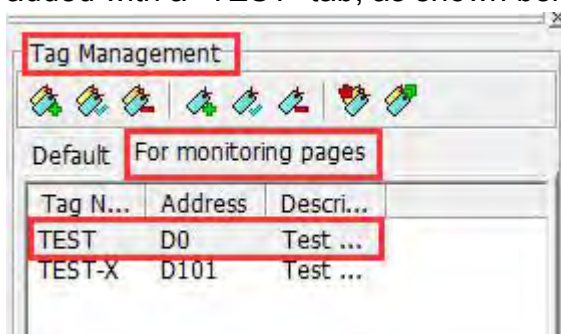

Step 5. Add "numeric entry" elements to the start screen, as shown in the figure below.

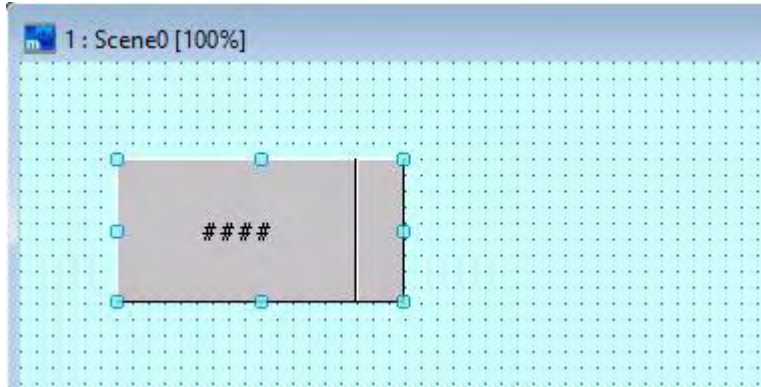

Step 6. Open the property page of the component, as shown in the figure below. After setting the label, you can directly use the pull-down option to select [Test] at the reading position instead of typing. Therefore, the use of tags can greatly improve the visibility of contacts and memories during operation, and reduce human error.

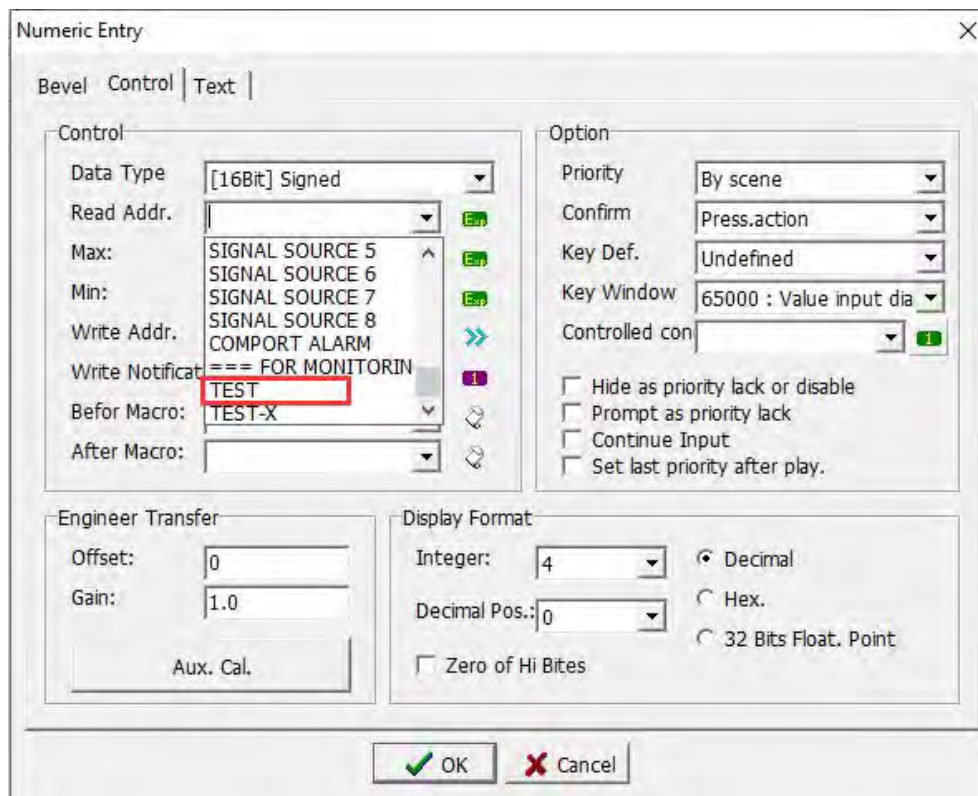



## Chapter 5 Language management

This software supports multiple languages. The purpose is to allow anyone to use the language and symbols they are familiar with to edit the required projects on this software platform. As a result, hmi can be used quickly, the readability can be improved visually, and the work efficiency can be increased.

Multi-languages can only be used in components that can display numbers or text. When we create a new project, the system will use the language preset by the operating system (here Simplified Chinese is taken as an example), so the text or numbers entered on the component are classified Under Simplified Chinese language. If we create a new English language, as shown below. At this time, you can choose Chinese or English here. If we previously set the component and set the component to text or number, we can find that when Chinese is selected, the component displays the text or number we entered, but when English is selected, the text and the numbers on the component disappeared because we did not enter text or numbers in the English language, so they did not appear.

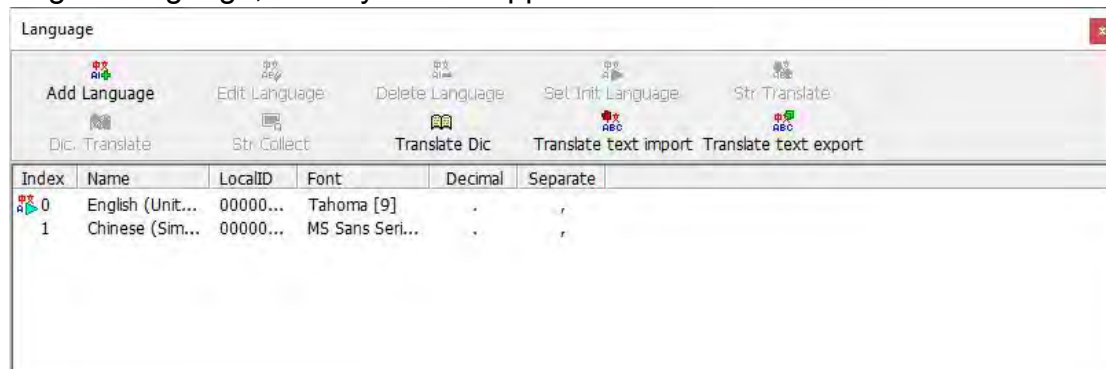

Therefore, to display several new languages, you must enter various new languages and characters on the component. We can create multiple languages in the language management. The object properties window of the component can select the language under [Status], [Text ] can input the text of the language we selected, so that no matter which language is selected, the text we entered for this language on the component will appear.

### 5.1 Add, edit, delete languages

After selecting [Project]-> [Language], there will be six options, as shown in the figure below.

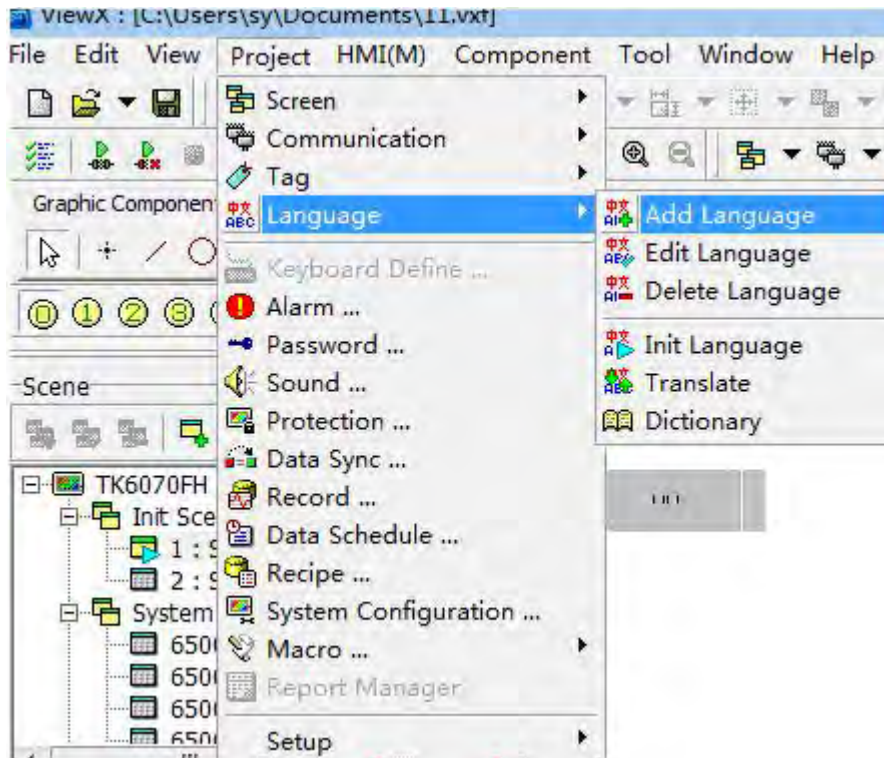

Directly click the language management icon in the toolbar , the language management dialog box shown as below.

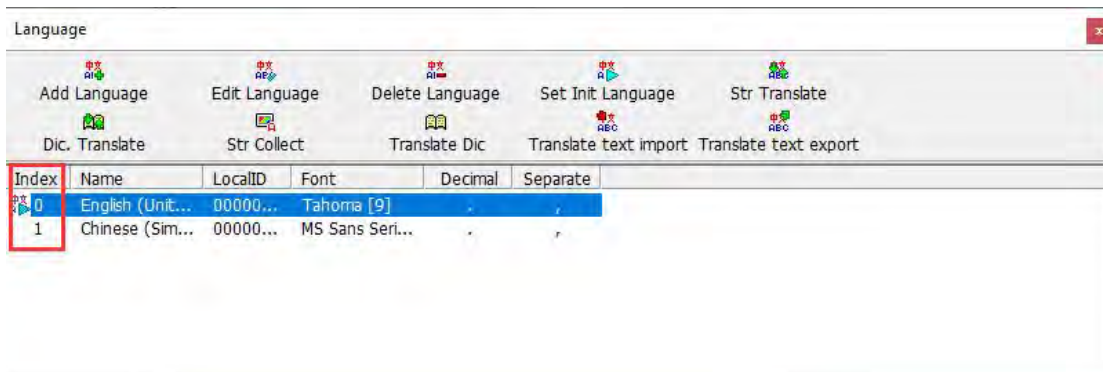

**Index:** The index field is the index value of each language and it is unique. Each index value corresponds to the system preset parameter N65342 [current screen language index]. Therefore, when the value of the system parameter is changed, the corresponding language will be switched according to the index value filled in the write position.

**Add language:** When you click this option, will pop up “setting dialog box”.

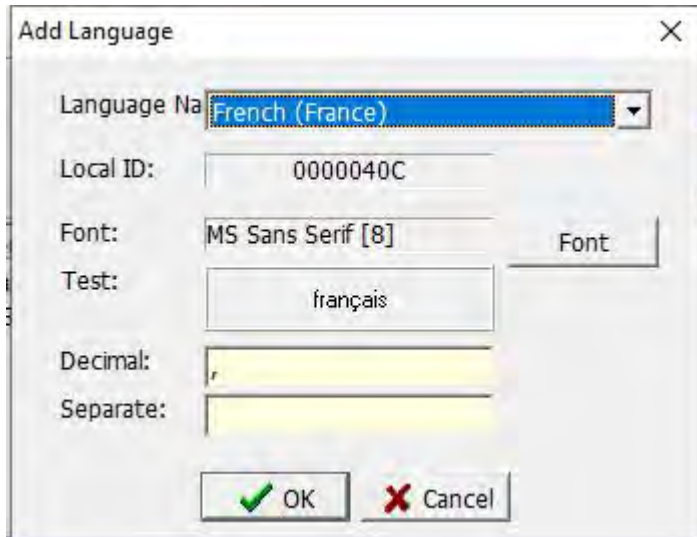

**Name:** Click the drop-down list to select the language to be added.

**Local ID:** The area code of the selected language area. This item is added by default.

**Font:** Displays the preset default font you selected.

**Select font:** Click this button to pop up the font selection dialog, as shown in the figure below. You can set the default font, glyph, size, effect, underline, and color of the new language.

**Test :** Display the template of the selected font.

**Decimal:** Set which symbol is displayed when the decimal point symbol is displayed.

**Separate:** Set which symbol to use when displaying the separator.

After clicking the [OK] button, a new language is added to the language management screen, as shown in the figure below.

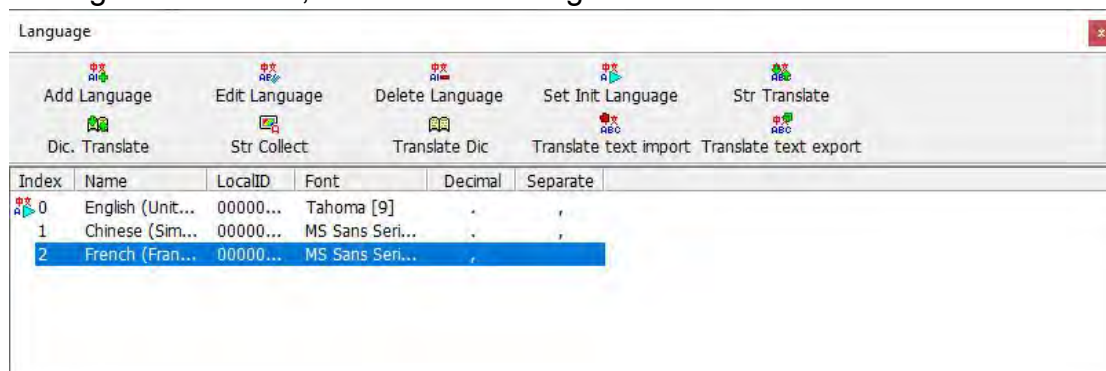

**Edit language:** Click this option to set the font, glyph, size, effect, underline, and color of the existing language. The editing screen is the same as that displayed in adding new language.

**Delete language:** Click this option to delete the existing language.

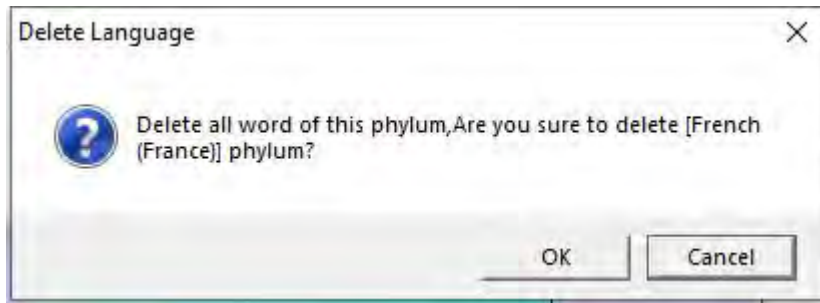

Set initial language: Click this option under multiple languages to set the initial language.

String translation: Click this option to convert the language on the screen to the selected language, as shown in the figure below.



Among them, the software program sets Chinese and English as preset translation functions. In addition, you can use the function of the translation dictionary to set the corresponding language text, as shown in the figure below.



**Dic. Translate:** Set the corresponding language translation by yourself.

**Translation text export:** When multiple languages are selected in the program, such as Chinese (Simplified) and English (UK), the text can be exported in batches, and the export format is a txt file, as shown in the figure below:

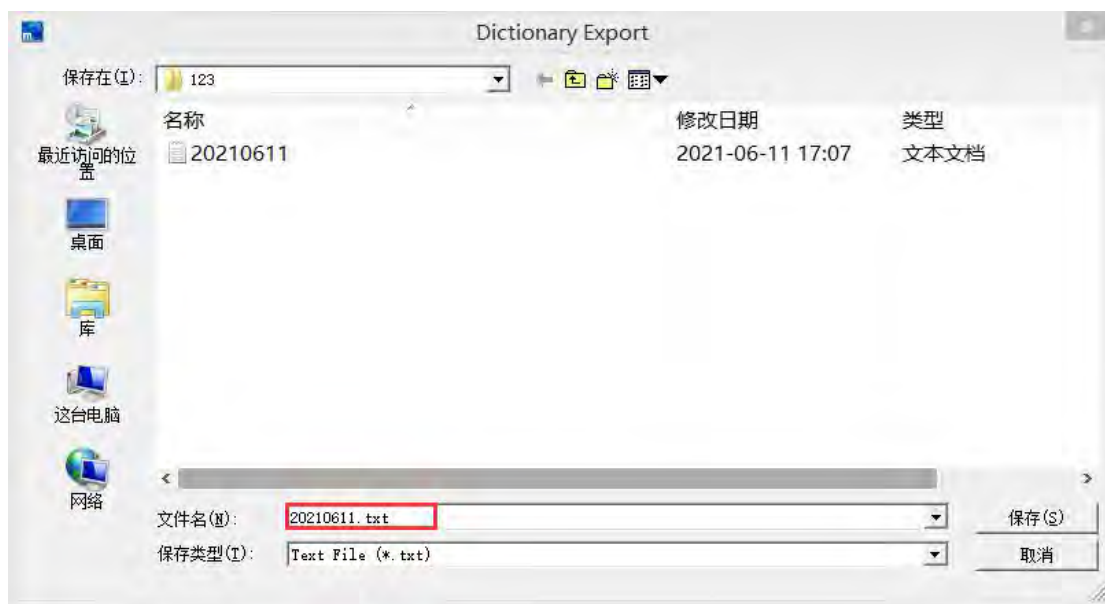





Open the document and manually translate each language: For example, 深圳市顾美科技有限公司 translates to Shenzhen Coolmay Technology Co., Ltd. (note that the format of the document should not be changed when translating, that is, the text should not be shifted and line-wrapped)



After the translation is completed, import the translated text through the [Translate text import] option.

**Translate text import:** Export from the above translated text and import it into the project for use after the translation is completed.

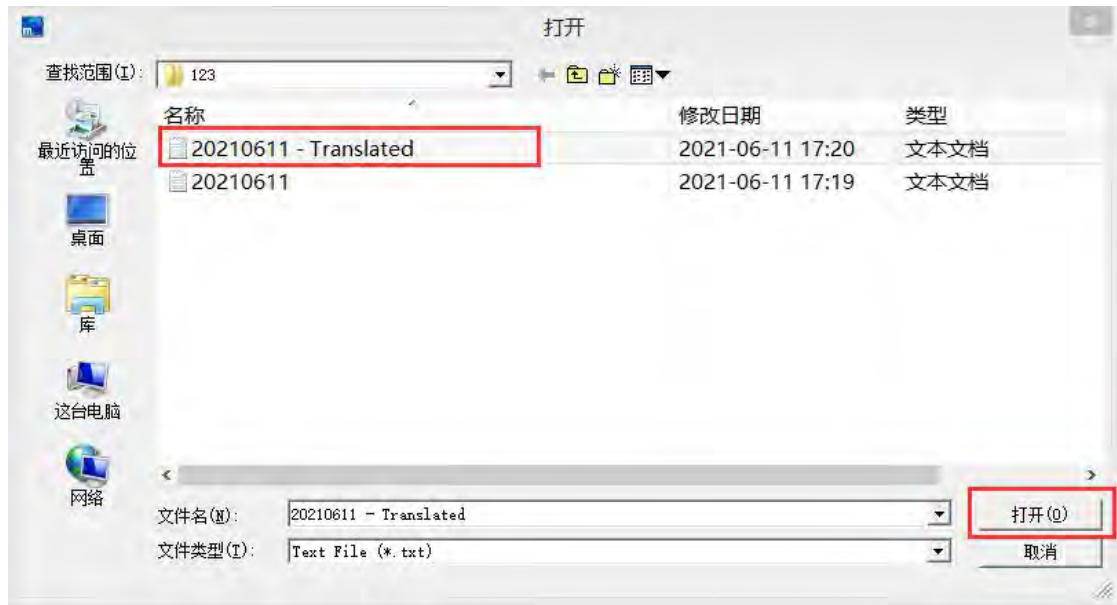

The effect is as follows:

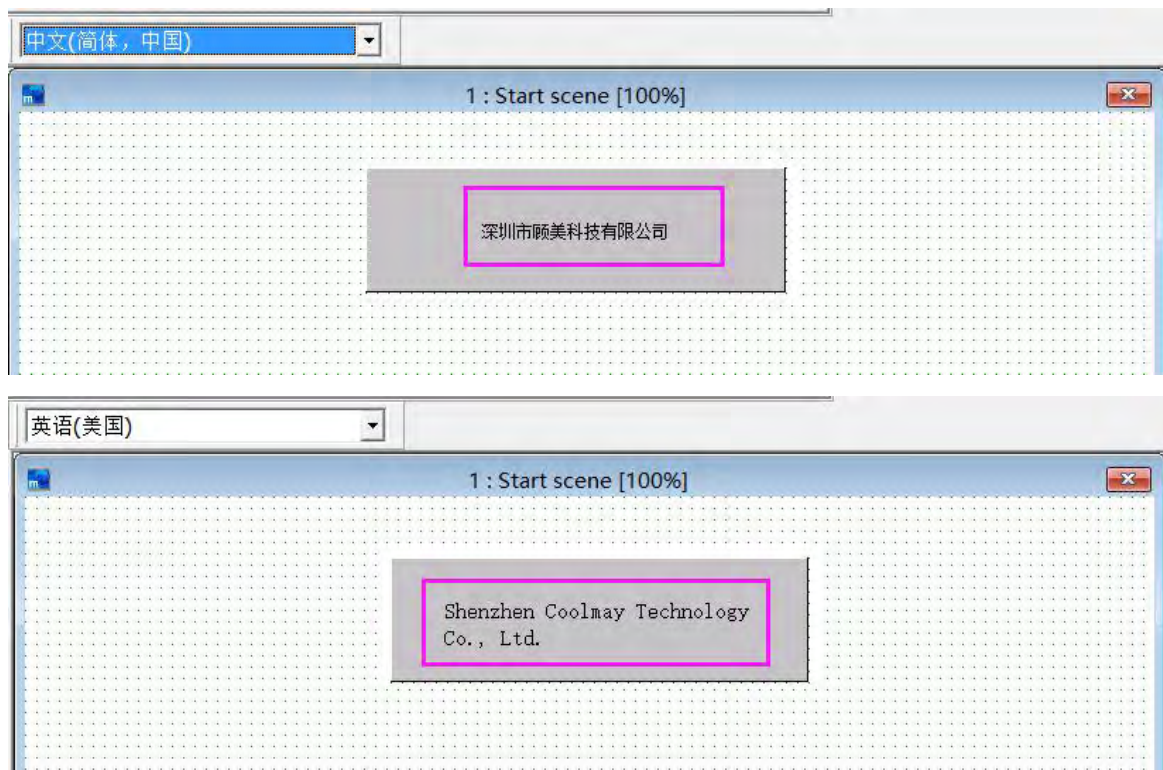

## 5.2 Multi-language and component cases

Step 1. Create a new project file.

Step 2. Add English language.

Step 3. Select the component. Here, take [Static Text] in [Static] as an example.

As shown below.

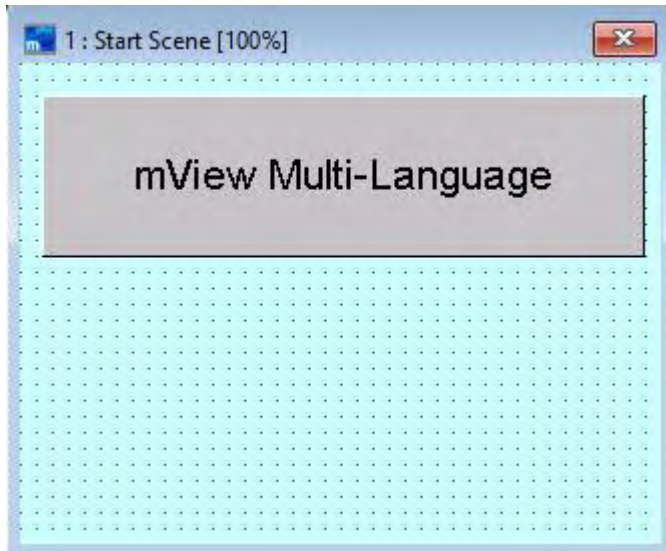

Step 4. Open the Static Text Properties dialog box. First set the English language as shown below.

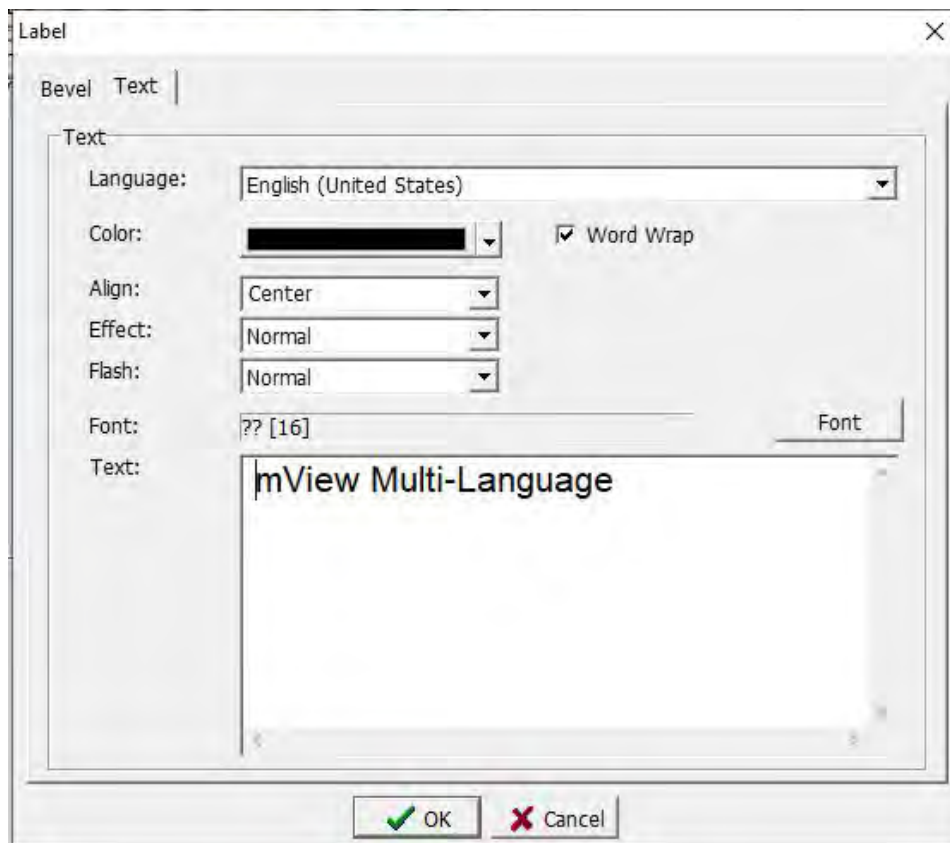

Step 5. Set the Chinese language again as shown below.

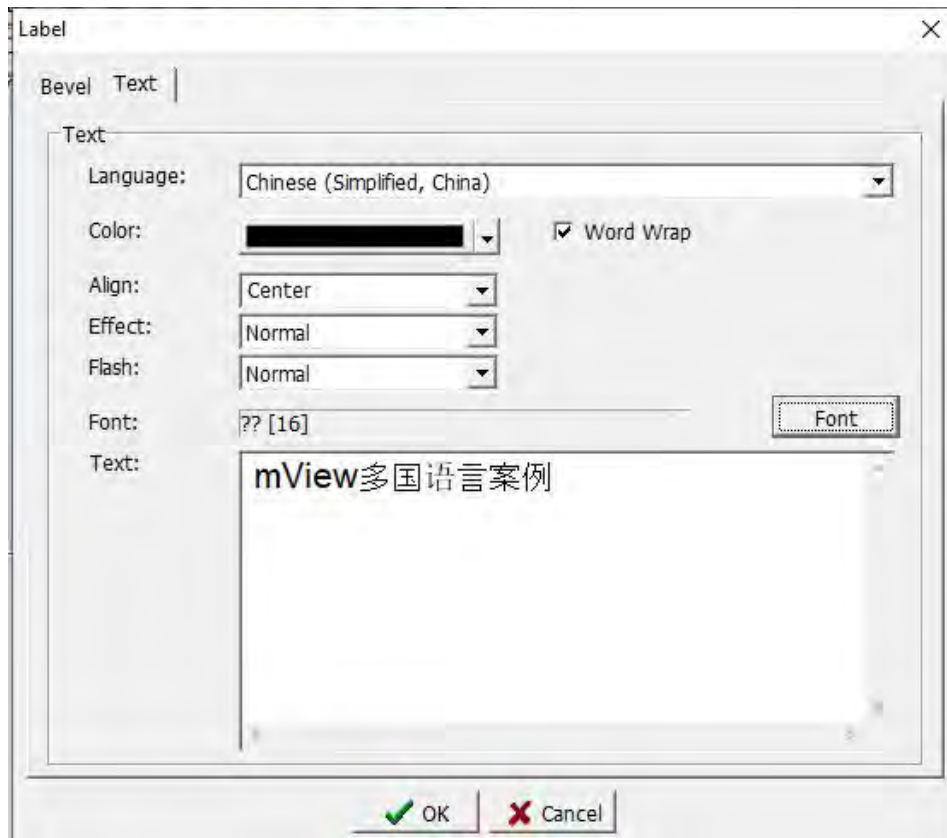

Step 6. When both languages are set, click the [OK] button. The static text will now display the font of the selected language. As described in the previous chapter, when Chinese or English is selected, different fonts are displayed.

Step 7. Add [value button] to the initial screen, open the object property window, select [variable or constant] in [action], and select [language index of present screen] in [write ADDRESS]. [Rules] Please enter [0], which refers to the index value mentioned in section 5.1, which indicates that the language family is Chinese, and 1 indicates English, as shown in the figure below.

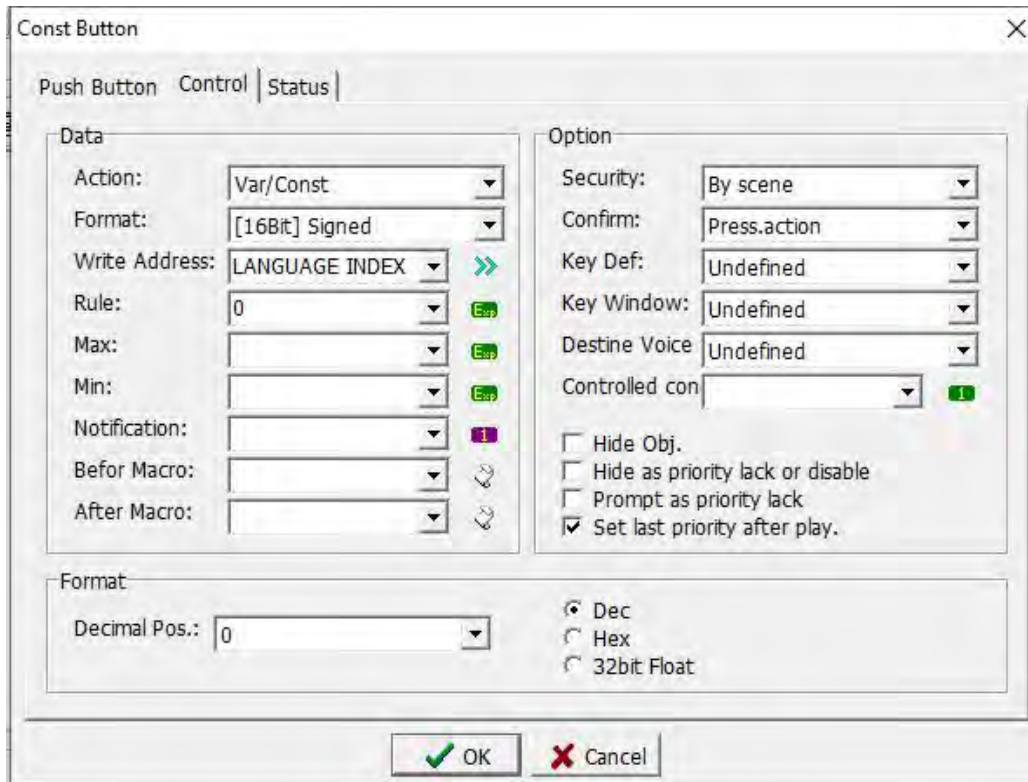

[Status] page, set the language of Chinese status and the language of English status, as below.

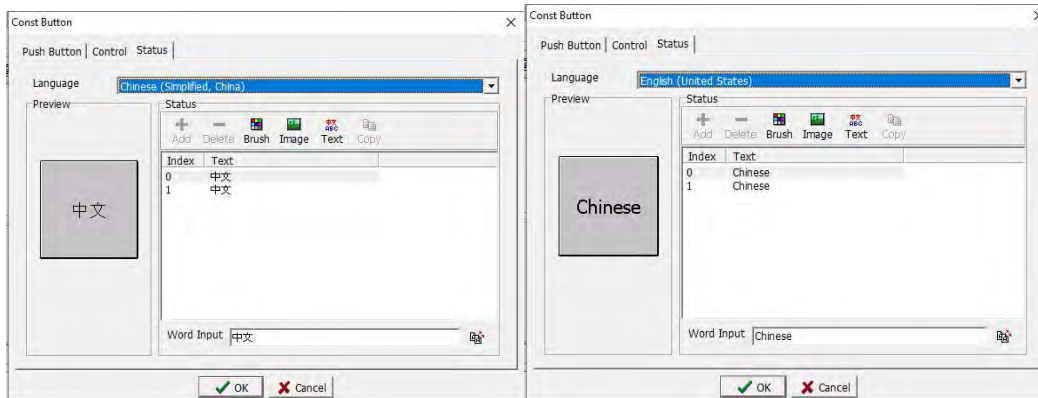

Step 8. Add a second [Value button], set the setting button properties as shown below



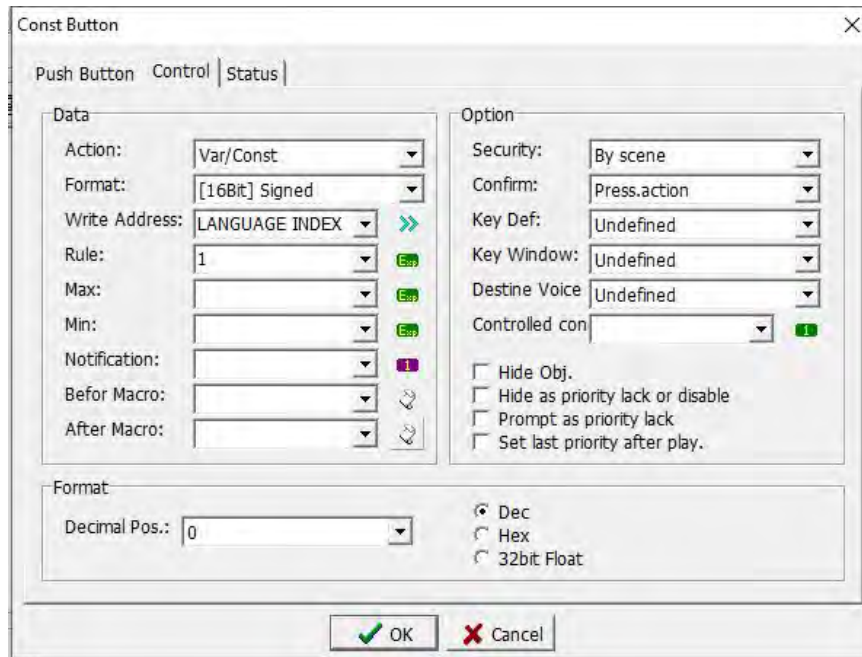

Set its status page to Chinese and English text as shown below.

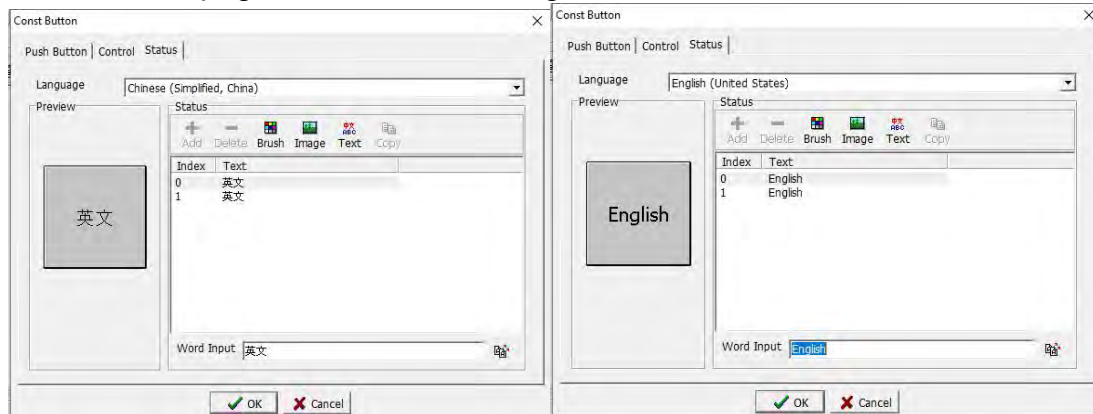

Step 9. The setting is completed, and the project can be downloaded to the HMI. Or select [HMI (M)]-> [Offline Execution] or use the hot key Shift + F9 to check the effect.

When you click the [English] button, the effect is as shown in the figure below.

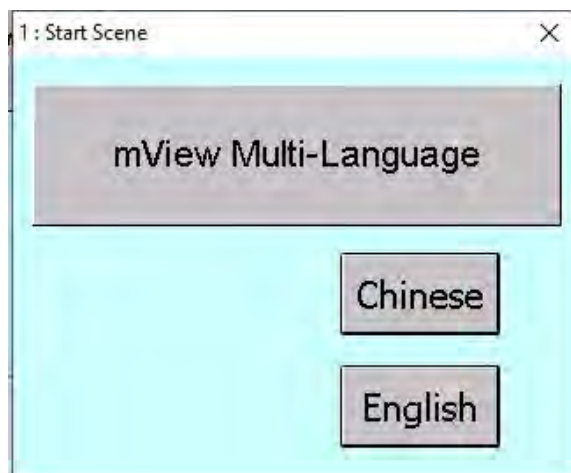

When you click the [Chinese] button, the effect is as shown below.



## Chapter 6 Alarm management

Click [Project]-> [Alarm] in the menu bar or directly select the [Alarm ] icon  in the toolbar to open the window, as shown in the figure below.

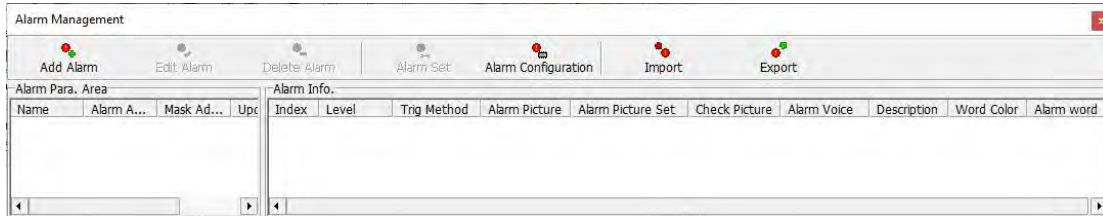

Click the New Alarm Area button to open the New Alarm Area window, as shown in the figure below.

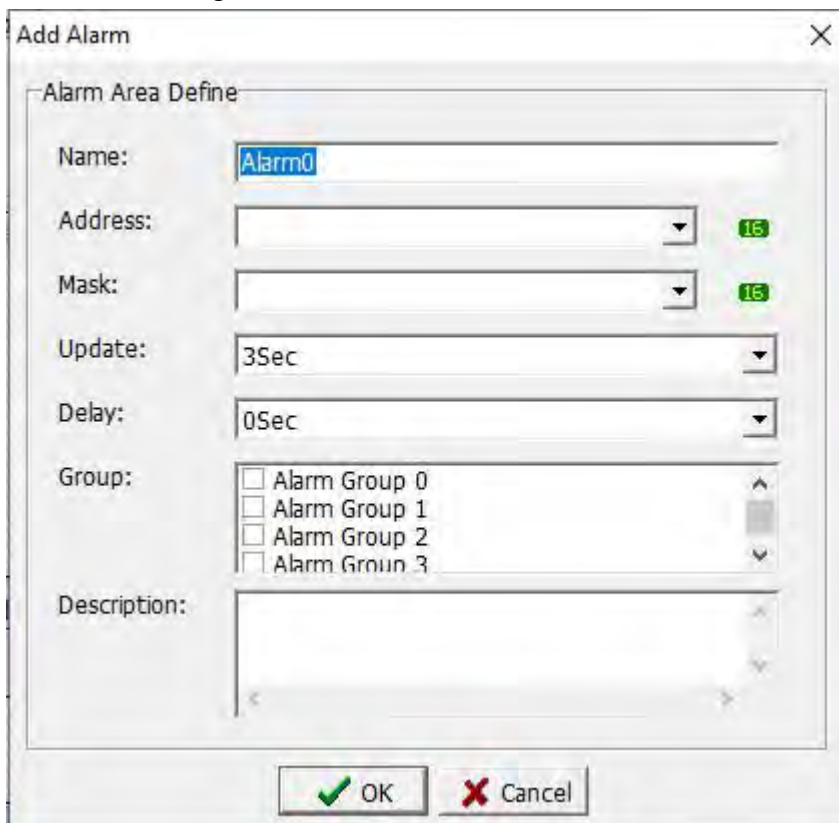

Name: Enter the set name for the newly added alarm zone.

Address: Enter the position of the variable, you can select it through the drop-down arrow symbol or directly enter the position of the variable. As shown in the figure above, the icon button  behind the input box indicates that the position must be WORD. Click the button to pop up the variable window as below to check which variable is in WORD type. At the same time, you can also enter or select the required variable in the number edit box as below.

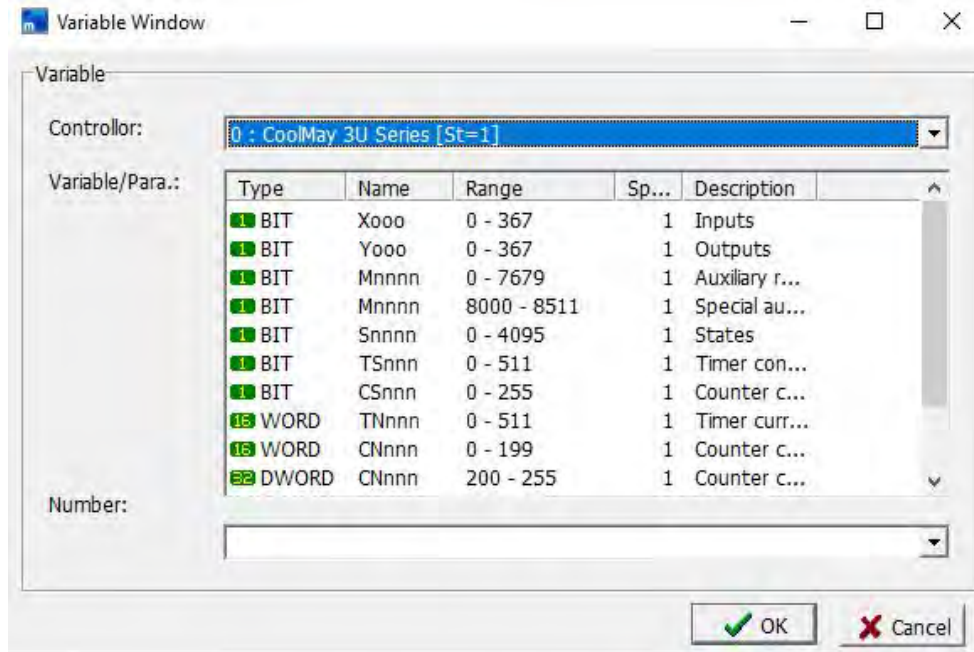

**Alarm shielded address:** When the alarm is triggered, this function can be used to shield the alarm, that is, the alarm message and sound are not displayed. The selection method of the shielded address is same as that of the alarm area address.

**Update cycle:** You can choose how often you want to update. If you select 3 seconds, it means that the alarm will be checked every 3 seconds.

**Classification group:** You can check which group this alarm will be classified into. Double click the left mouse button in the group to edit the group name.

**Start-up delay:** Select whether to wait for the controller to start the alarm time after the completion of data creation.

**Help:** Type a help statement for this alarm.

When the alarm area is added, the [Alarm] is shown in the figure below. At this time, there are two setting buttons added in the toolbar of the window, which are [Edit Alarm] and [Delete Alarm], [Edit Alarm] means to edit the data of the current alarm area again. [Delete alarm] is to delete the data of the selected alarm event area.

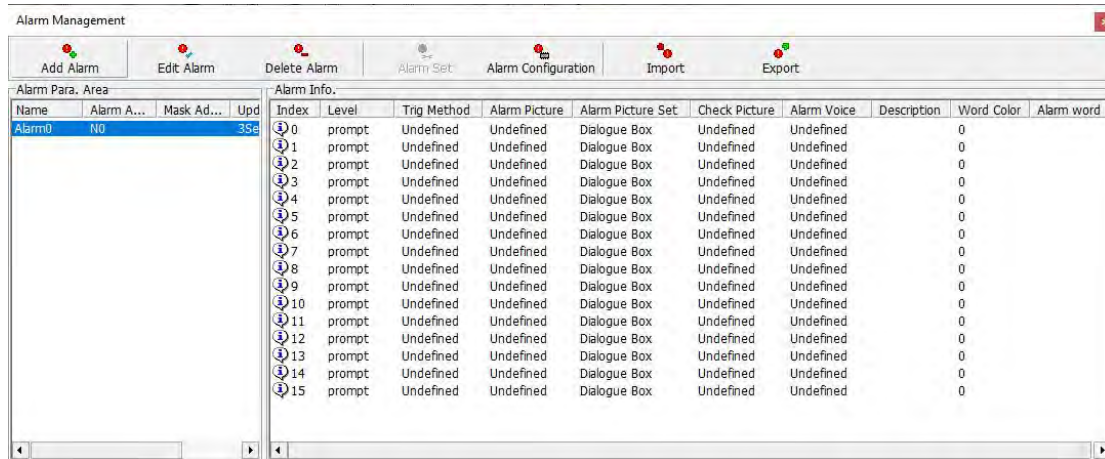

As below figure, at the selected message to be set, and then press [Alarm Setting] or double-click directly on the selected message, will pop up the alarm setting window as below .

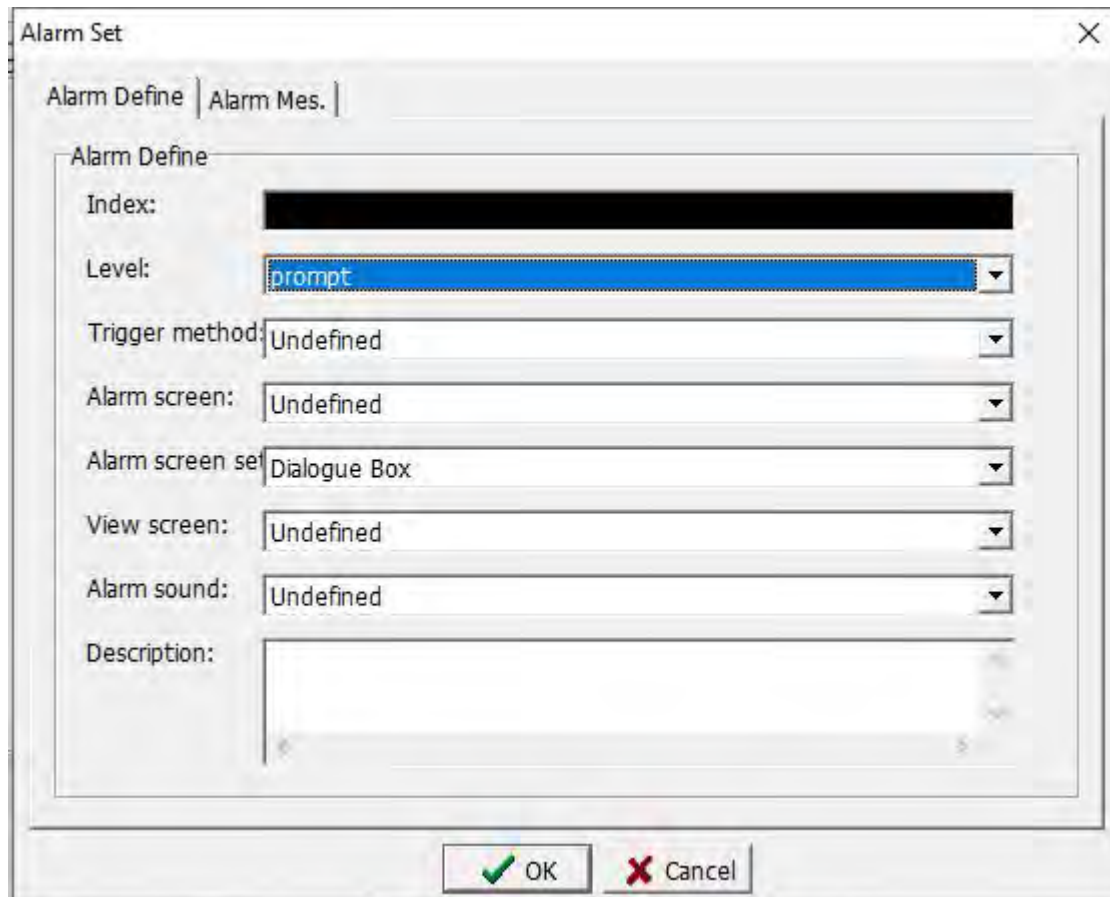

## Alarm define

### Alarm definition

Index value: Because the alarm location is stored in WORD, the size of WORD is 2bytes. When WORD is 1, it will be converted to binary [0000 0000 0000 0001]. Please refer to the table below.



2power	15	14	13	12	11	10	9	8	7	6	5	4	3	2	1	0
2Carry	0	0	0	0	0	0	0	0	0	0	0	0	0	0	0	1
index	5	4	3	2	1	0										

Level: After setting the level, it is convenient for users to edit which level this alarm is.

Trigger method:

Positive edge: When the data changes from 0 to 1, trigger the alarm.

Negative edge: When the data changes from 1 to 0, trigger the alarm.

Positive and negative edge: When the data changes from 0 to 1 or from 1 to 0, trigger the alarm.

High level: When the data is 1, trigger the alarm.

Low level: When the data is 0, trigger the alarm.

Positive edge and high level mixing: When the positive edge and high level conditions are met, trigger the alarm.

Negative edge and low level mixed: When the negative edge and low level conditions are met, trigger the alarm.

Alarm screen: Select the screen that appears during the alarm. You must add a new dialog box before editing the screen to be used during the alarm.

Alarm screen settings:

Dialog box: 1. When selecting a dialog box, please note that the set screen must have the function of leaving the dialog box; otherwise, when the alarm occurs, the set dialog box will cause the problem of being unable to leave.

2. When operating the screen (screen type is dialog box), if the alarm occurs at this time, the screen that has not been completely operated before will disappear.

Screen change: Select the display screen to jump to when the alarm occurs, such as the current alarm display table screen.

Message: When selecting message, you can choose seconds for the message to appear, will not affect the function of the current operation.

View screen: You can add a dialog box to edit the screen. When an alarm occurs, you want to see what kind of alarm occurred before, this screen will appear. We set the screen expressed by this alarm, and can do convenient alarm point to search screen.

Alarm sound: Select the sound when the alarm occurs, you must first set the sound in the sound management.

Description: A description of this setting.

## Alarm message

Alarm message

Language: Set the language when the alarm message is displayed.

Color: Set the color of the text when the alarm message is displayed.

Text: Set the text displayed in the alarm message.

Click the [Alarm Configuration] button. The alarm configuration dialog box is displayed as below:

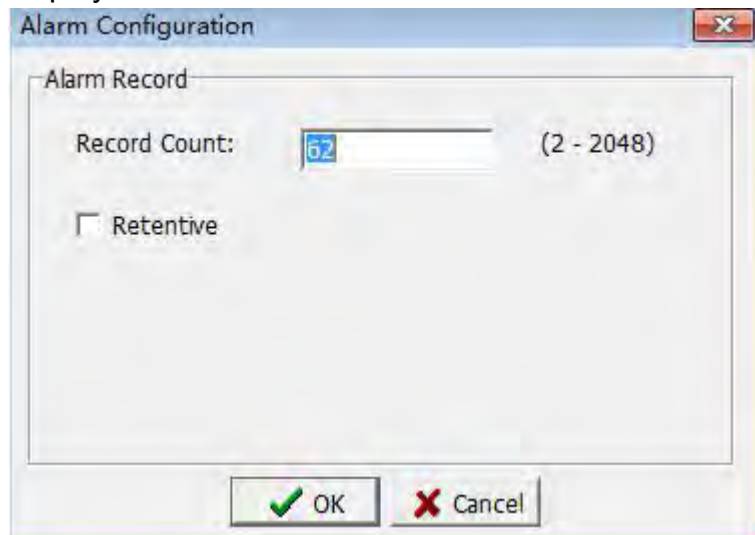

#### Alarm record

Record Numbers: Set the number of recorded alarms, ranging from 2 to 2048. When the number of alarms exceeds the set number, the first recorded data will be deleted one by one to increase the latest alarm record.

Use power-off retention: Select this option to save the data in the alarm log when the HMI is powered off and then Restart on.

## 6.1 Alarm case

This chapter uses a simple case to explain how to set the alarm (trigger, shield), and uses the alarm record table to display the occurred alarm information.

Step 1. Before setting the alarm information, you need to edit the alarm screen, as shown in the following figure .

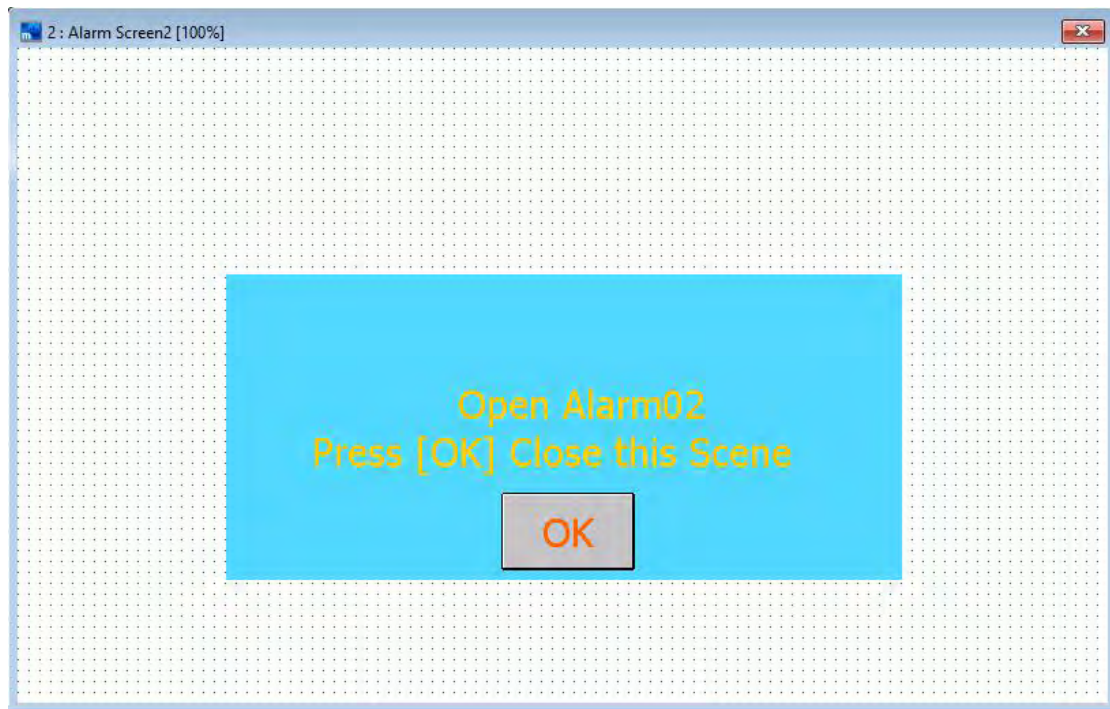

Step 2. Click [Project]-> [Alarm] in the menu bar or directly select the [Alarm] icon  in the toolbar to open the it, As shown in the following figure.

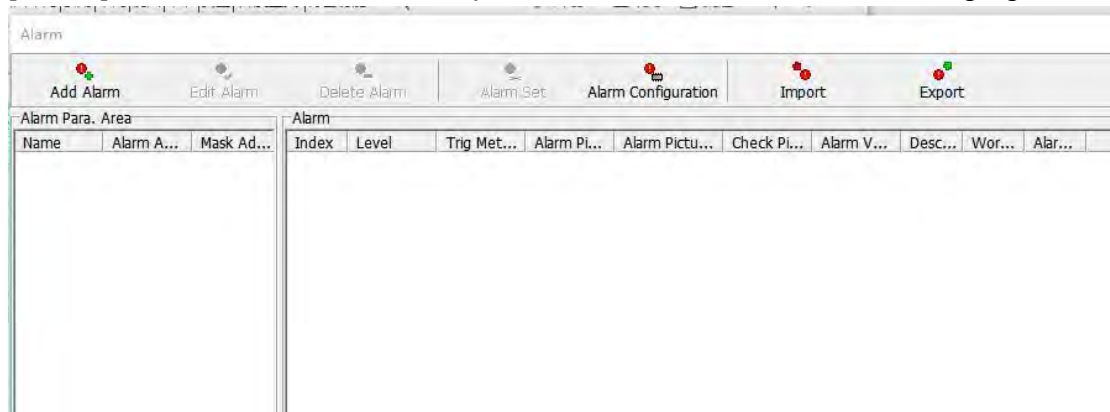

Step 3. Click the [Add Alarm] button to open the new alarm area window and set the parameters as shown in the following figure.

After the settings are completed, click the [OK] button to save the settings. Show as shown in the following figure.

Name	Alarm A...	Mask Ad...	Upd	Index	Level	Trng Method	Alarm Picture	Alarm Picture Set	Check Picture	Alarm Voice	Description	Word Color	Alarm word
Alarm-Urg...	N0	N1	35e	0	prompt	Undefined	Undefined	Dialogue Box	Undefined	Undefined		0	
				1	prompt	Undefined	Undefined	Dialogue Box	Undefined	Undefined		0	
				2	prompt	Undefined	Undefined	Dialogue Box	Undefined	Undefined		0	
				3	prompt	Undefined	Undefined	Dialogue Box	Undefined	Undefined		0	
				4	prompt	Undefined	Undefined	Dialogue Box	Undefined	Undefined		0	
				5	prompt	Undefined	Undefined	Dialogue Box	Undefined	Undefined		0	
				6	prompt	Undefined	Undefined	Dialogue Box	Undefined	Undefined		0	
				7	prompt	Undefined	Undefined	Dialogue Box	Undefined	Undefined		0	
				8	prompt	Undefined	Undefined	Dialogue Box	Undefined	Undefined		0	
				9	prompt	Undefined	Undefined	Dialogue Box	Undefined	Undefined		0	
				10	prompt	Undefined	Undefined	Dialogue Box	Undefined	Undefined		0	
				11	prompt	Undefined	Undefined	Dialogue Box	Undefined	Undefined		0	
				12	prompt	Undefined	Undefined	Dialogue Box	Undefined	Undefined		0	
				13	prompt	Undefined	Undefined	Dialogue Box	Undefined	Undefined		0	
				14	prompt	Undefined	Undefined	Dialogue Box	Undefined	Undefined		0	
				15	prompt	Undefined	Undefined	Dialogue Box	Undefined	Undefined		0	

Step 4. Select the information bar with an index value of 2 and click the [Alarm Setting] button, or double-click in the information to open the alarm information setting dialog box. The setting contents are shown in the following figure.

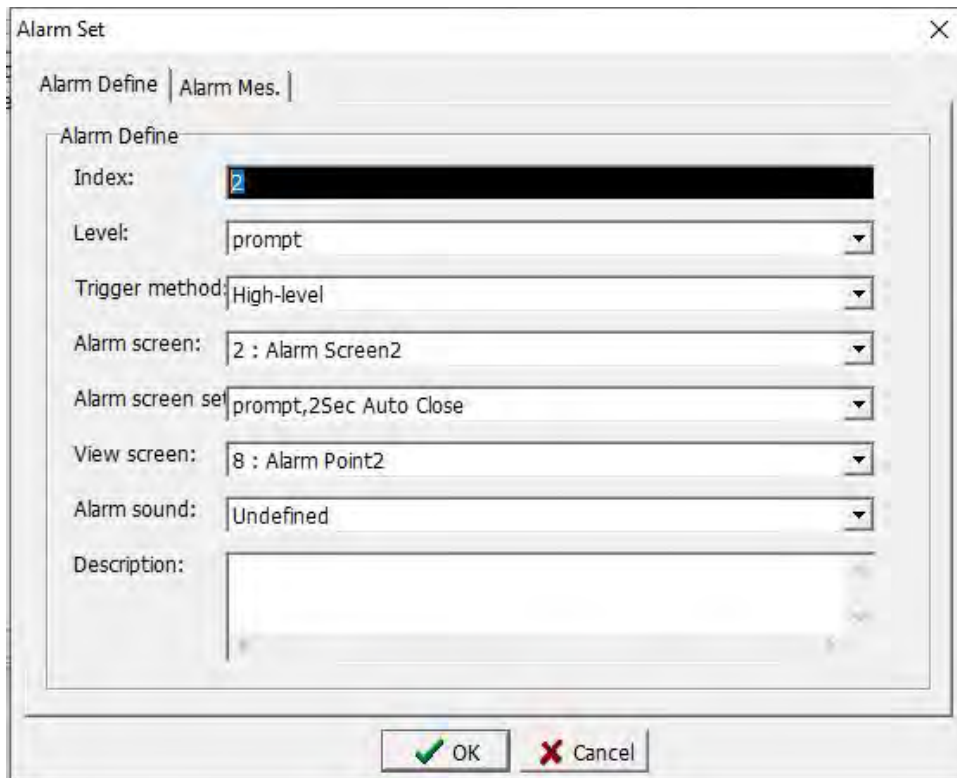

After the settings are completed, click the [OK] button to save the settings. Show As shown in the following figure.

Alarm Para. Area				Alarm Info.									
Name	Alarm A...	Mask Ad...	Upd	Index	Level	Trig Method	Alarm Picture	Alarm Picture Set	Check Picture	Alarm Voice	Description	Word Color	Alarm word
Alarm-Urg...	N0	N1	35e	0	prompt	Undefined	Undefined	Dialogue Box	Undefined	Undefined	0	0	0
				1	prompt	High-level	2 : Alarm S...	prompt,0.5Sec ...	7 : Alarm P...	Undefined	0	0	0
				2	prompt	High-level	2 : Alarm S...	prompt,2Sec Au...	8 : Alarm P...	Undefined	0	0	0
				3	prompt	High-level	2 : Alarm S...	prompt,1Sec Au...	9 : Alarm P...	Undefined	0	0	0
				4	prompt	Undefined	Undefined	Dialogue Box	Undefined	Undefined	0	0	0
				5	prompt	Undefined	Undefined	Dialogue Box	Undefined	Undefined	0	0	0
				6	prompt	Undefined	Undefined	Dialogue Box	Undefined	Undefined	0	0	0
				7	prompt	Undefined	Undefined	Dialogue Box	Undefined	Undefined	0	0	0
				8	prompt	Undefined	Undefined	Dialogue Box	Undefined	Undefined	0	0	0
				9	prompt	Undefined	Undefined	Dialogue Box	Undefined	Undefined	0	0	0
				10	prompt	Undefined	Undefined	Dialogue Box	Undefined	Undefined	0	0	0
				11	prompt	Undefined	Undefined	Dialogue Box	Undefined	Undefined	0	0	0
				12	prompt	Undefined	Undefined	Dialogue Box	Undefined	Undefined	0	0	0
				13	prompt	Undefined	Undefined	Dialogue Box	Undefined	Undefined	0	0	0
				14	prompt	Undefined	Undefined	Dialogue Box	Undefined	Undefined	0	0	0
				15	prompt	Undefined	Undefined	Dialogue Box	Undefined	Undefined	0	0	0

Step 5: Return to the starting screen, design the starting screen, set the value of N0 by using the increment and decrement buttons, and use the display lamp to display N0 bit situation. As shown in the following figure.



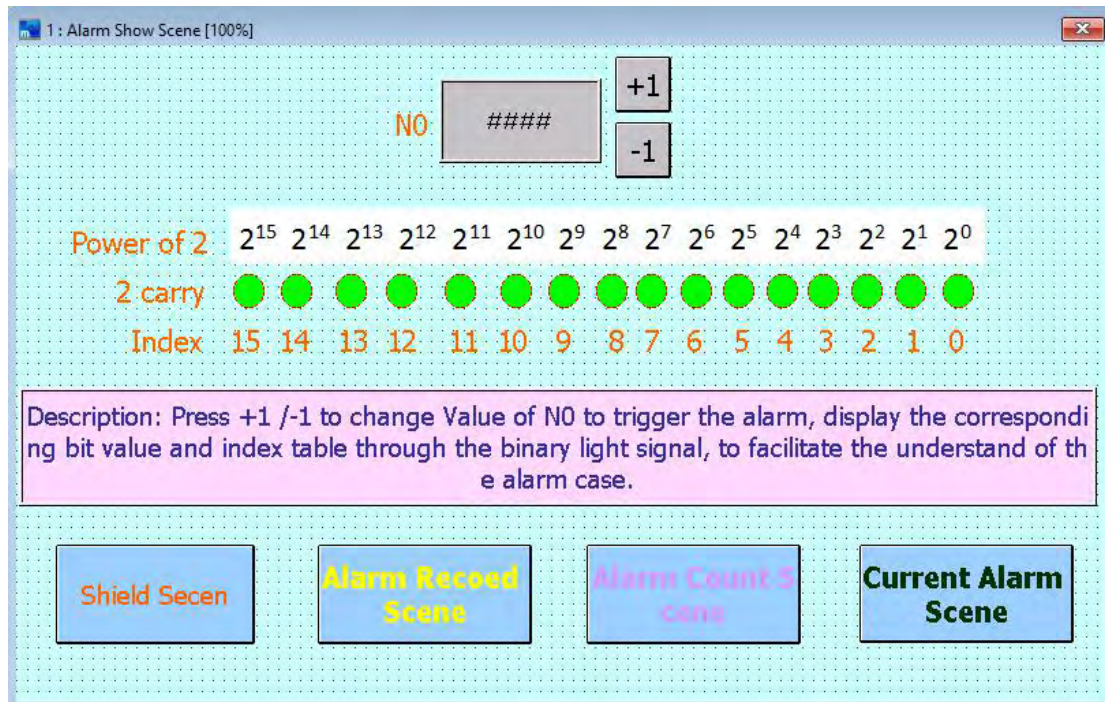

The new added screen is set as a shielding screen, design the shielding screen, set the value of NO by using the increment and decrement buttons, and use the display lamp to display NO bit situation. As shown in the following figure.

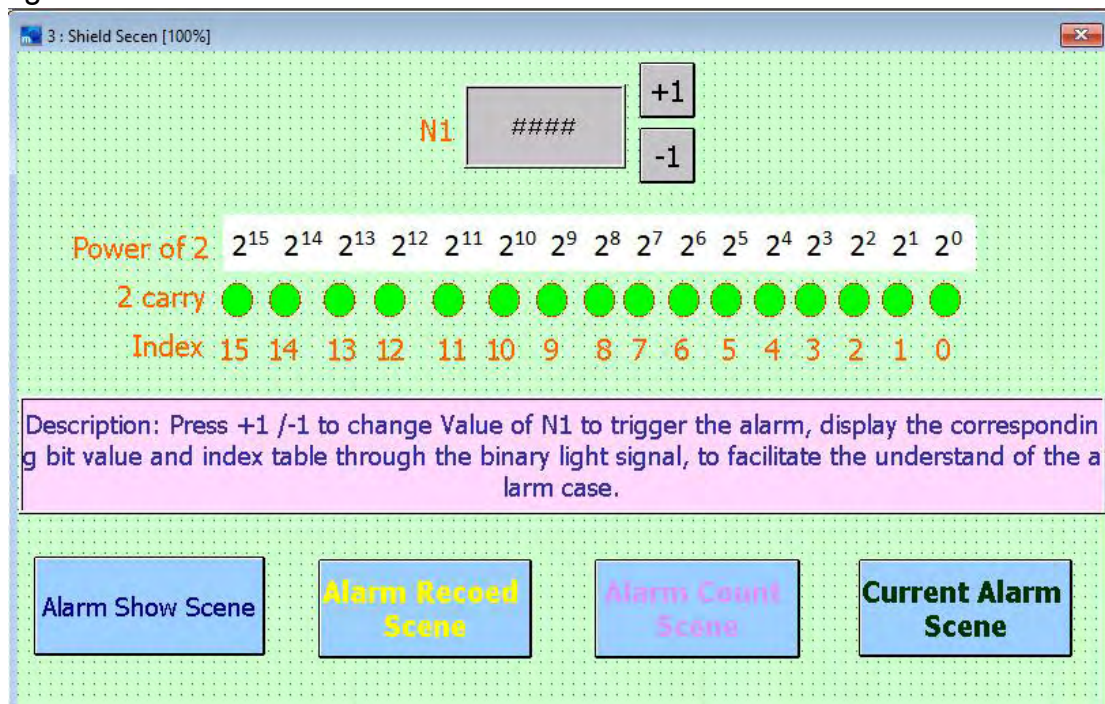

Use [Alarm Display Table], [Alarm Count Table] and [Current Alarm Table] respectively to design one screen to record the alarm, as shown in the following three figures. Please refer to section 3.4.16 for specific instructions on the alarm record table.

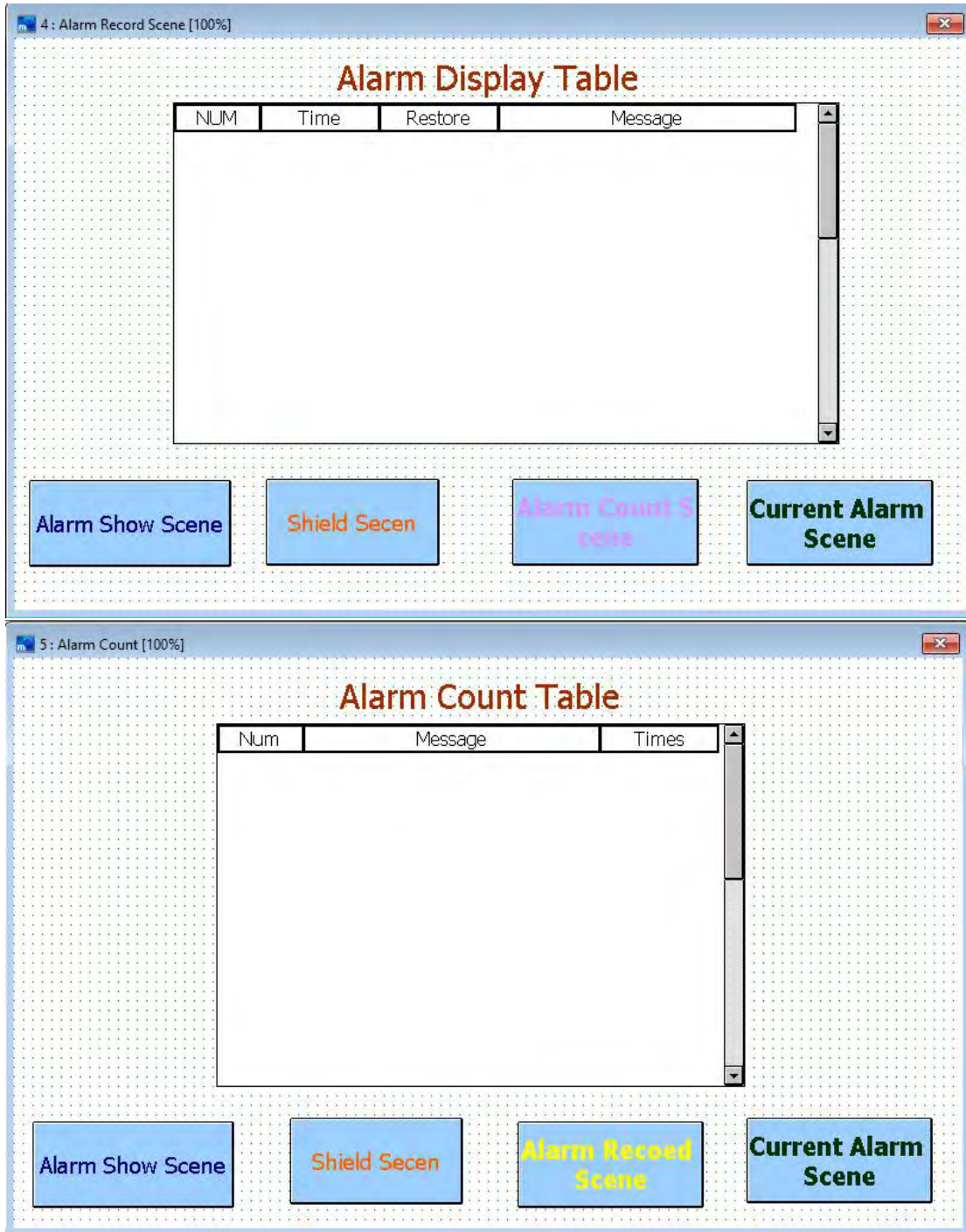



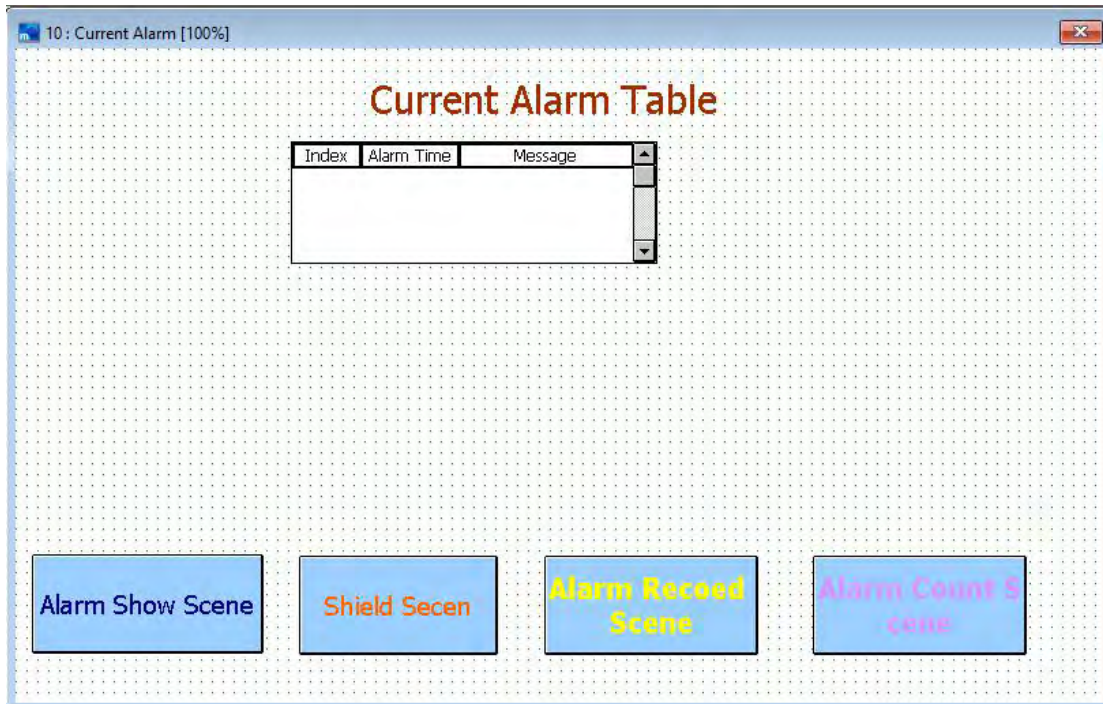

Step 6. After all screen settings are completed, you can start executing actions. Click [Offline Execution] or press [Shift]+[F9], and the execution screen is shown in the following figure.



At this time, we can find that when clicking the [+] button, the value of NO changes from [0] to [1], but the alarm is not triggered until [4]. Setting the high level trigger, why does it being triggered when value is 4? the alarm location is stored in WORD. In step 4, we select index 2 in [Alarm] to set, that is, when the second bit of NO is 1, the value of NO must be 4 to trigger. Because the WORD data size is 2bytes and is [0000 0000 0000 0000] (refer to the table in

this chapter) in binary terms, when in the high level triggers, the binary value corresponding to index 2 is 1, that is, [0000 0000 0000 0100], and the corresponding binary screen is  $2^2$  power,  $1 * 2^2$  power = 4, so the setting of index 2 will only be triggered when NO value is 4.

Step 7. If the user does not turn off the alarm or shield the alarm after the alarm occurs, the alarm screen will be reproduced every other update cycle according to the update cycle which is set in [Alarm (Event) Management] (3 seconds in this case) until the alarm is turned off or shielded.

When an alarm occurs, the display information of [Alarm Display Table], [Alarm Count Table] and [Current Alarm Table] are shown as below.

[Alarm Display Table] will be compiled into a record table according to the alarms that have occurred.

4: Alarm Record Scene ×

### Alarm Display Table

NUM	Time	Restore	Message
000	15:17:28		Alarm Happen02
001	15:17:31		The front door is opened

Alarm Show Scene

Shield Secen

Alarm Count 3  
same

Current Alarm  
Scene

[Alarm Count Table] All the number of alarms that have occurred so far will be counted and compiled into a count table.

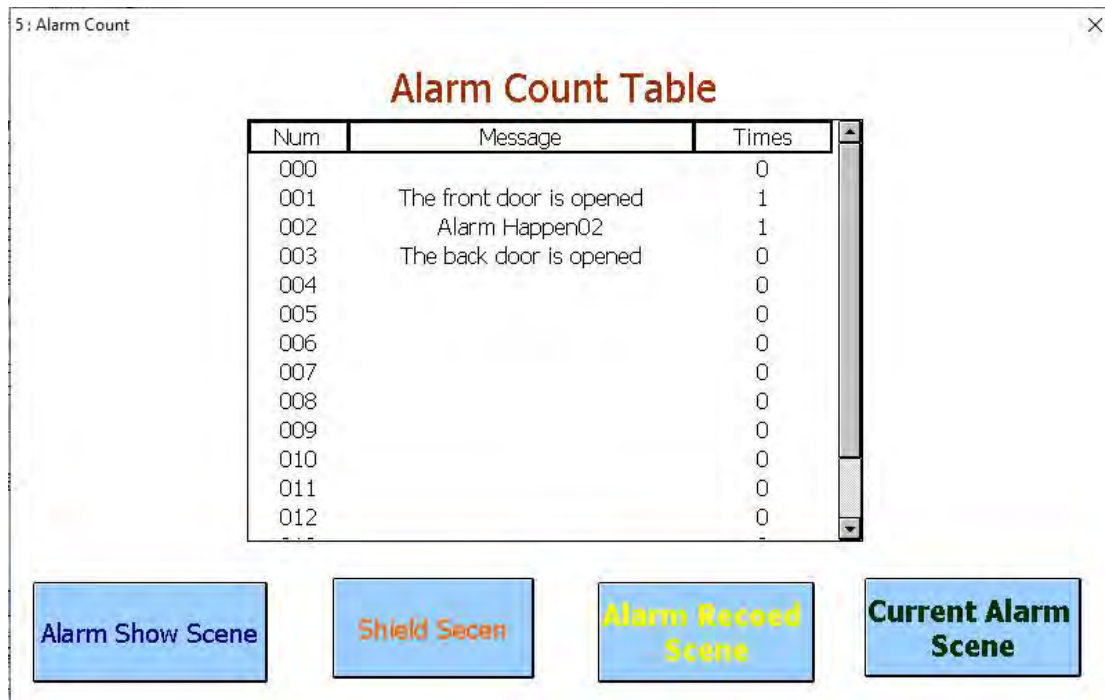

[Current Alarm Table] Displays the alarm information that is currently happening and has not been cleared into the record table.

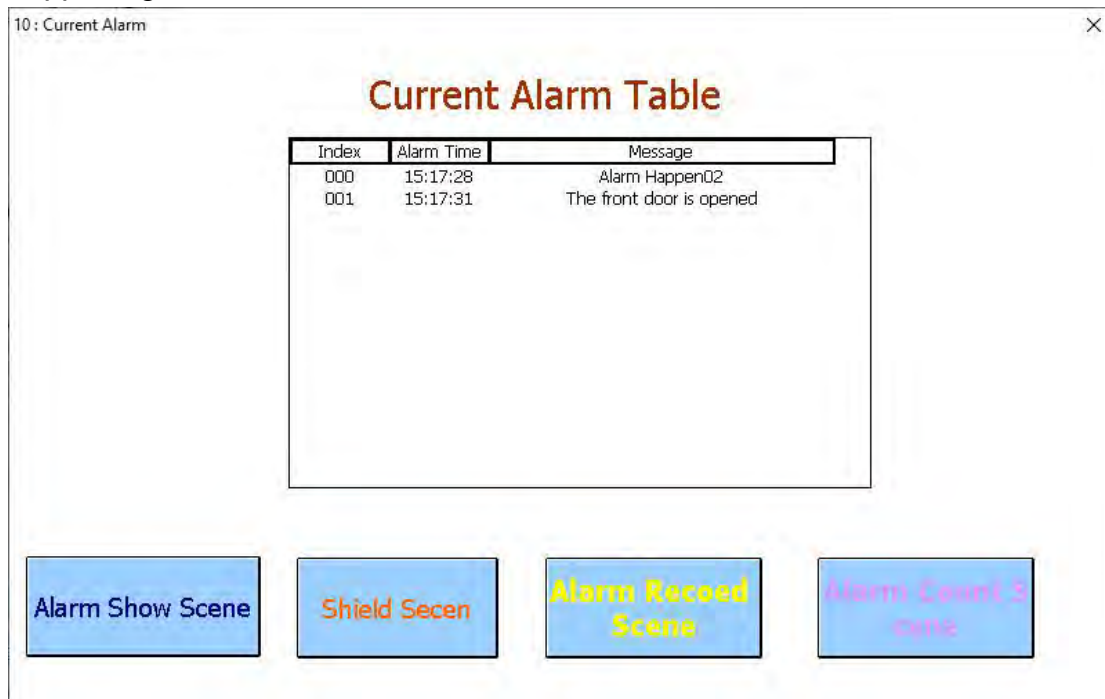

Step 8: After the alarm occurs, the alarm information sent needs to be closed or shielded. The method of closing the alarm information is to restore the value of N0, namely restore the bit corresponding to the index value to 0. Shield alarm information refers to setting the value of alarm shielded address N1 to be the same as that of N0. As shown in the following figure, alarm information can be shielded.



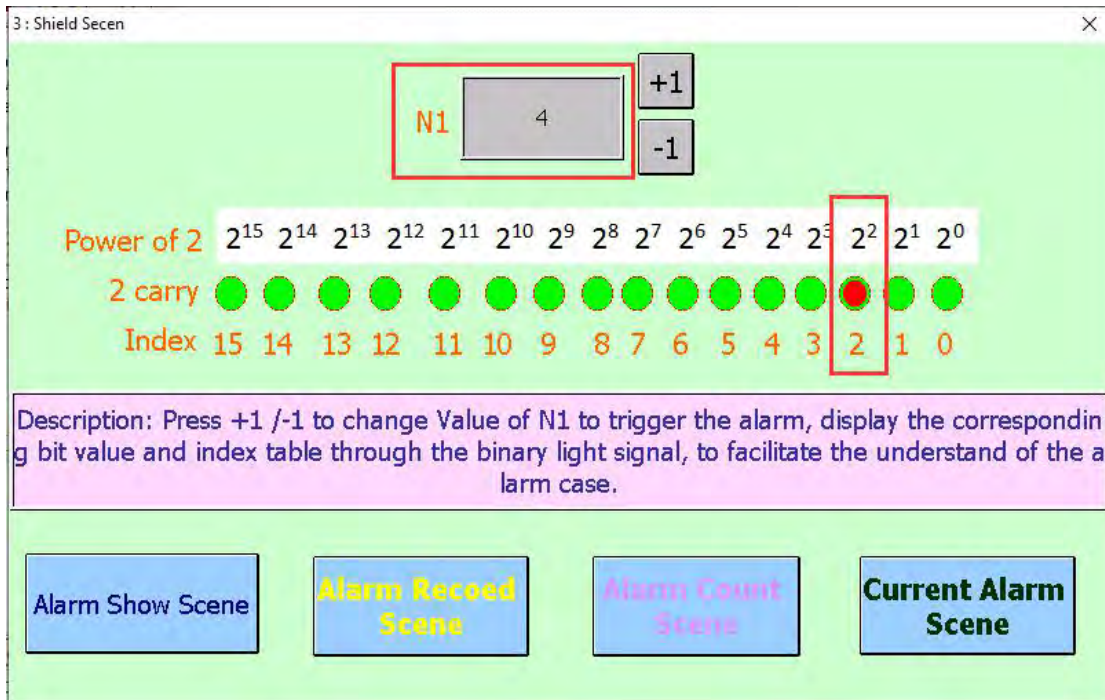

At this time, the display information of [Alarm Display Table], [Alarm Count Table] and [Current Alarm Table] are shown in the following three figures.

[Alarm Display Table] records all alarms that have occurred. If the alarm has been cleared or shielded, the recovery time will be displayed.

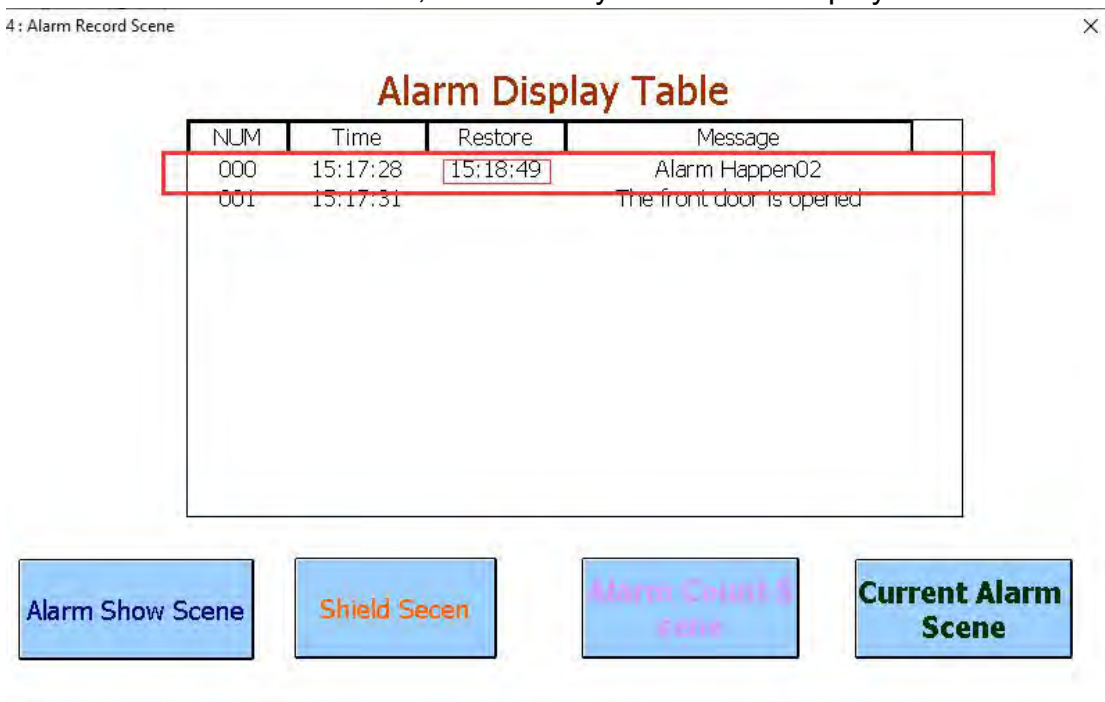

[Alarm Count Table ] is the same as before, and will always count the times each alarm occurs.

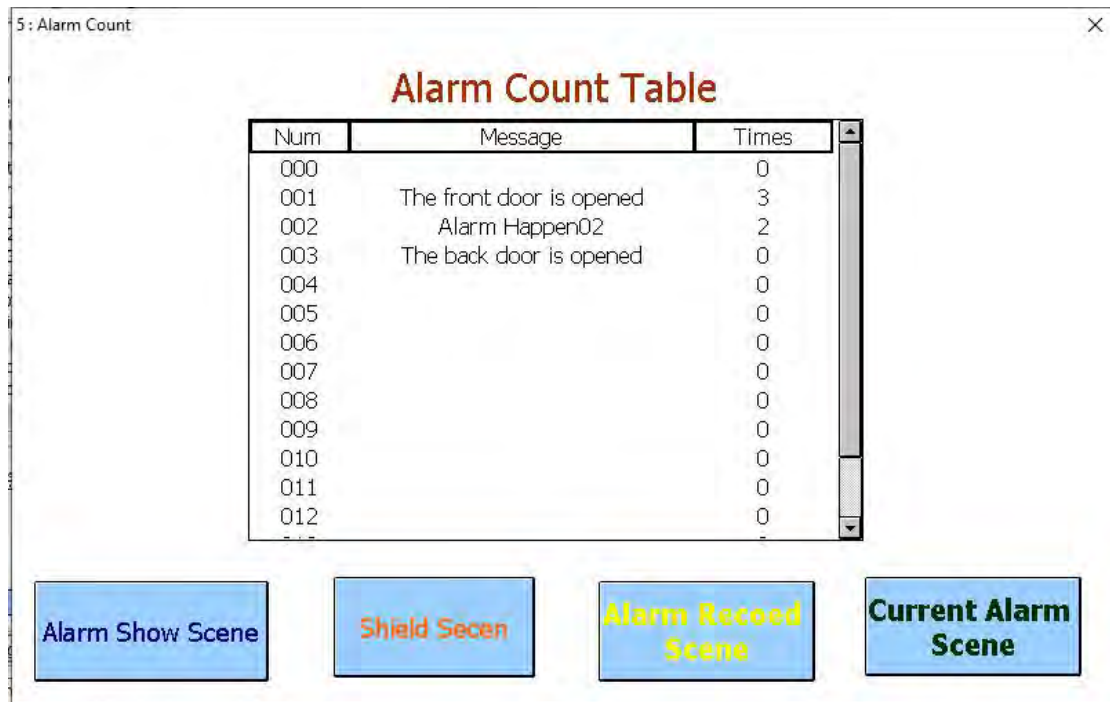

Because the alarm has been cleared, there is no record of any alarm in [Current Alarm Table].

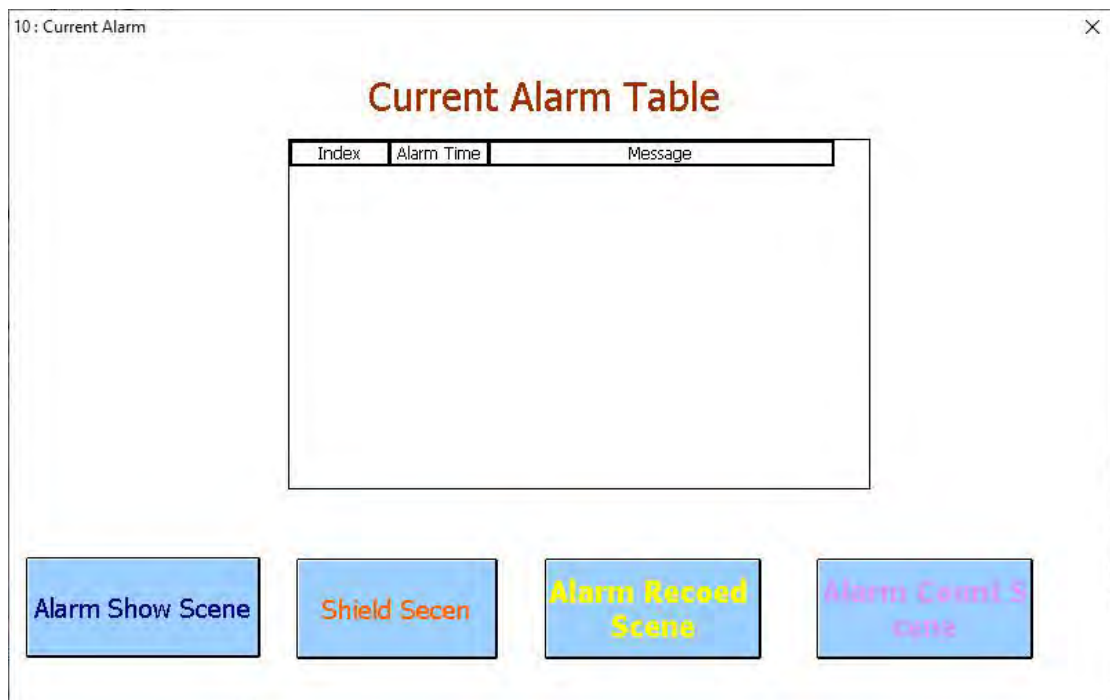

So far, the basic description of the alarm information settings is completed.

The following steps will introduce to use the inspection screen to mark fault points.

Step 9. First add the viewing screen in the alarm setting dialog, as shown in

the figure below.

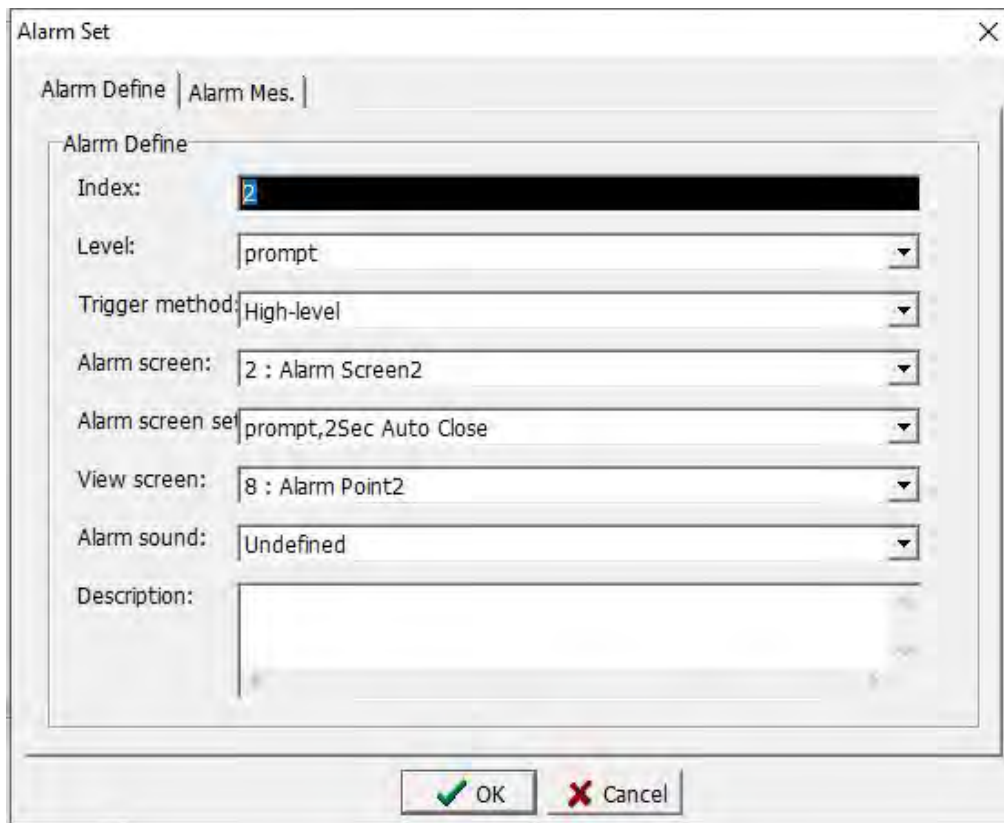

Step 10. Change the screen editing of the current alarm screen to below.

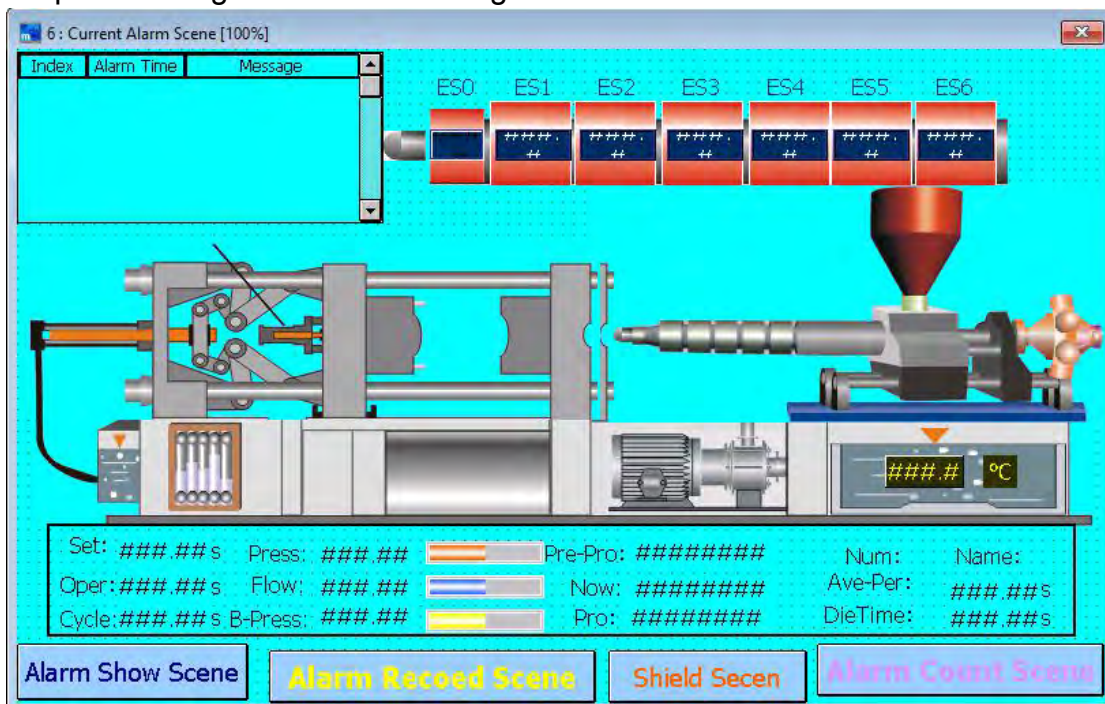

Enter [Current alarm table] property setting page. On the advanced setting page, when selecting the items in [Options], the viewing screen is displayed. select it. As shown below.



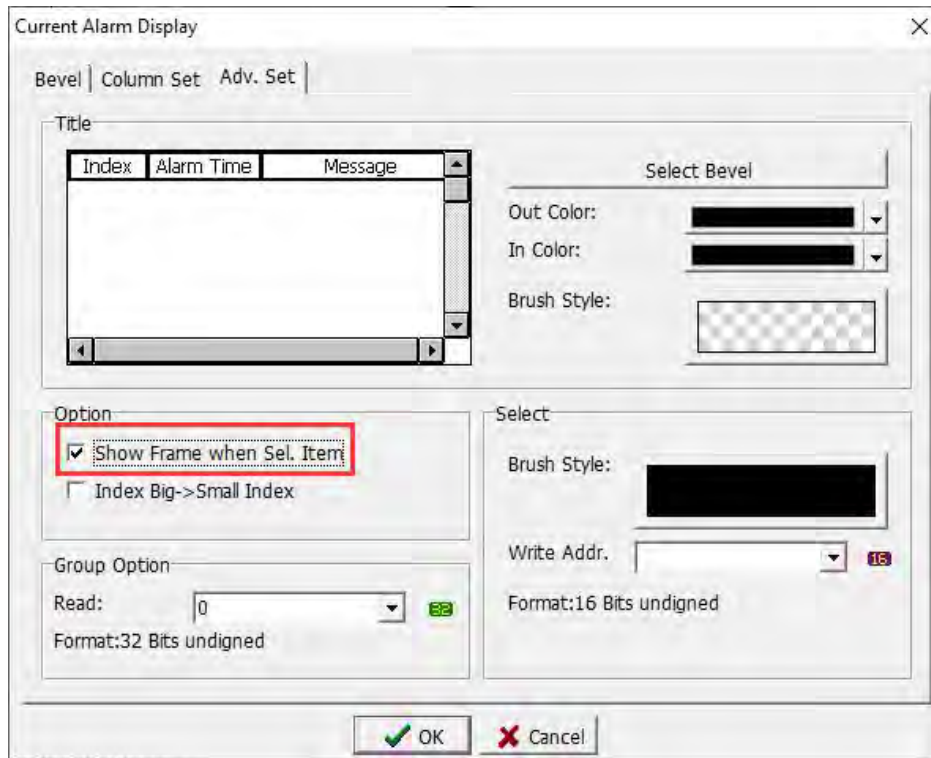

Plan [View Screen 1], [View Screen 2], and [View Screen 3] as shown below

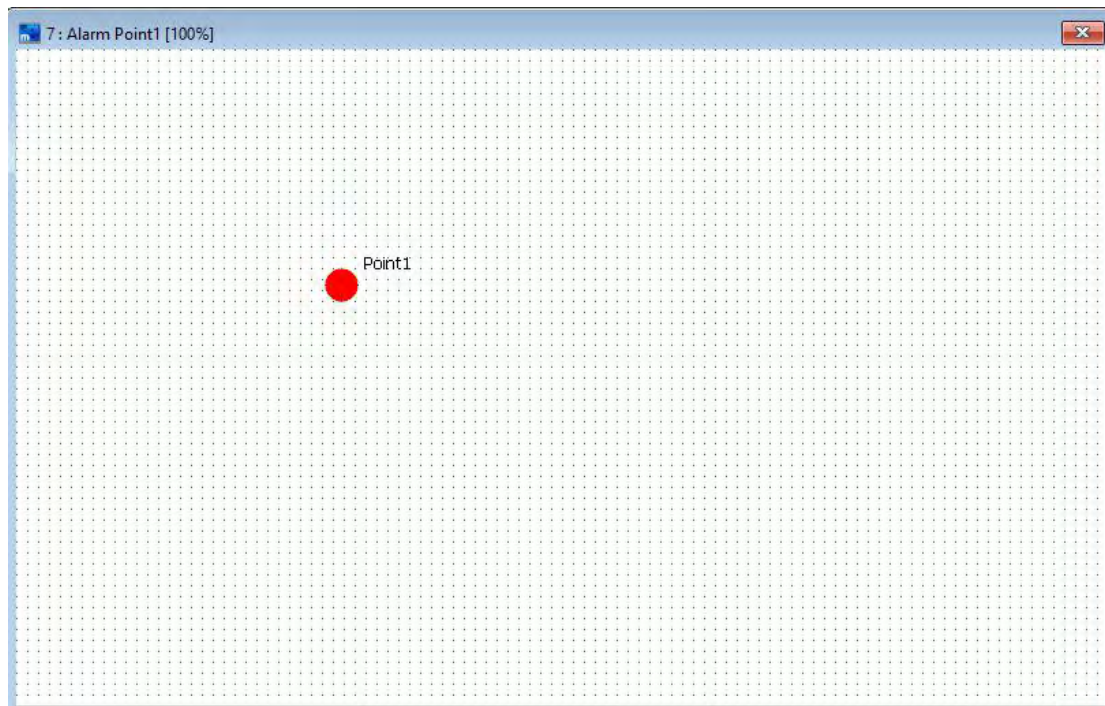

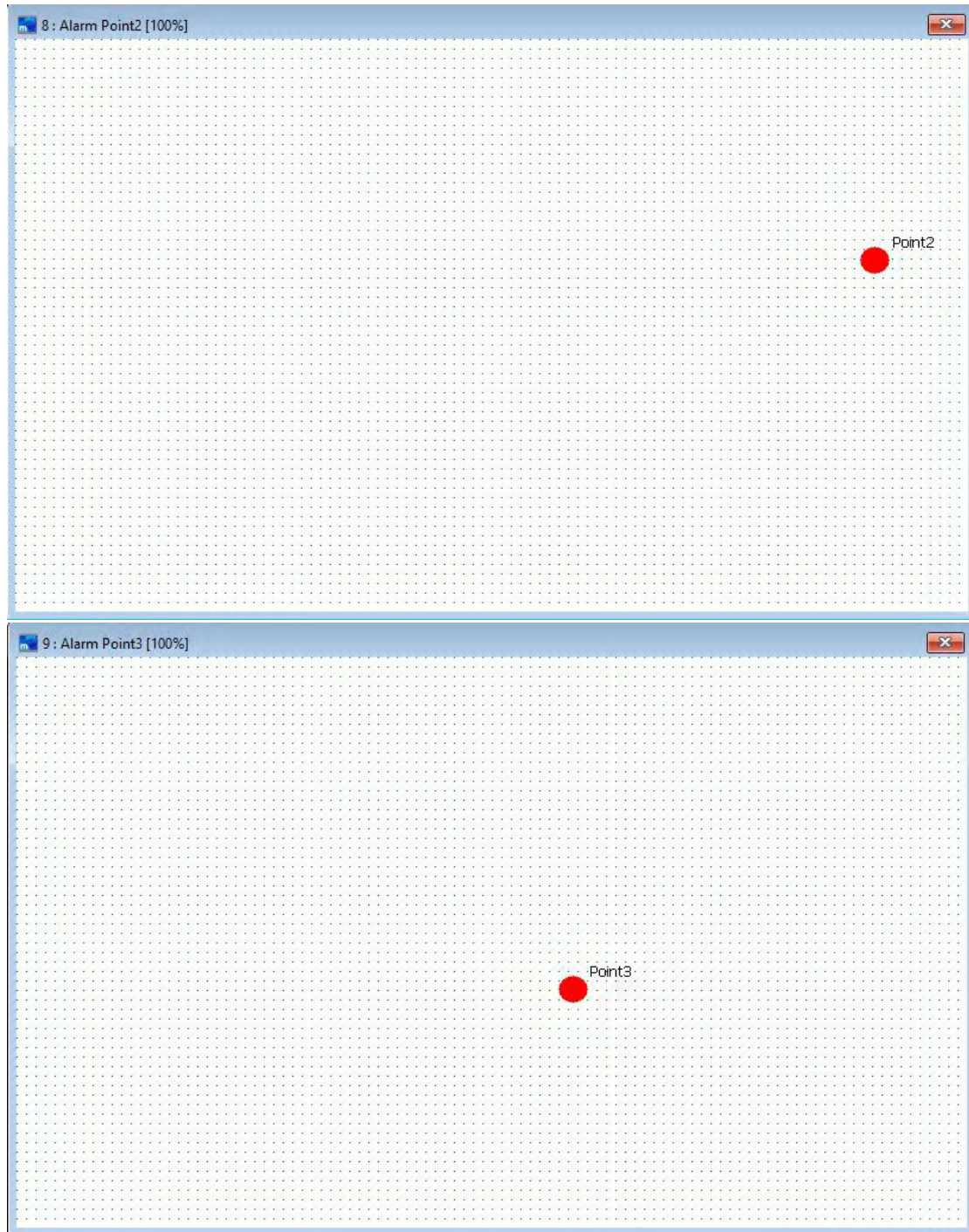

Step 11. Repeat step 4 to set the actions of alarm indexes 1, 2, and 3, and set the viewing screen like View screen 1, View Screen 2, View Screen 3. That is, when the value of N0 is 14, three alarm messages are triggered simultaneously. As shown below



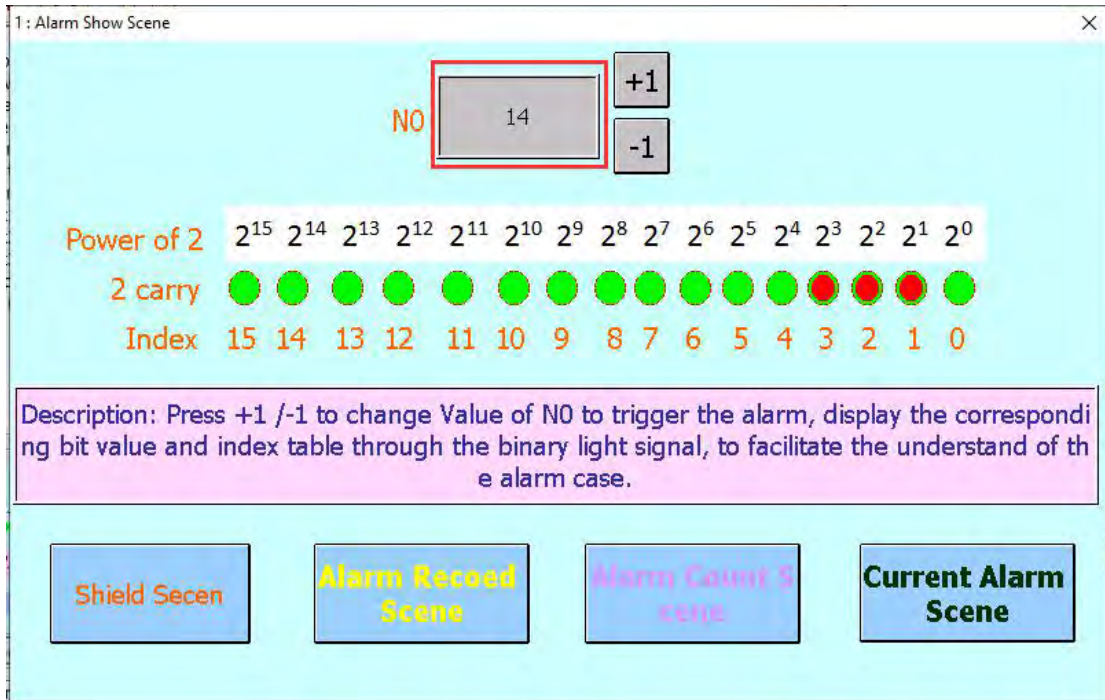

At this time, enter the [Current Alarm Screen] and you can see that there are three alarm information in the [Current Alarm Table], as shown in the figure below.

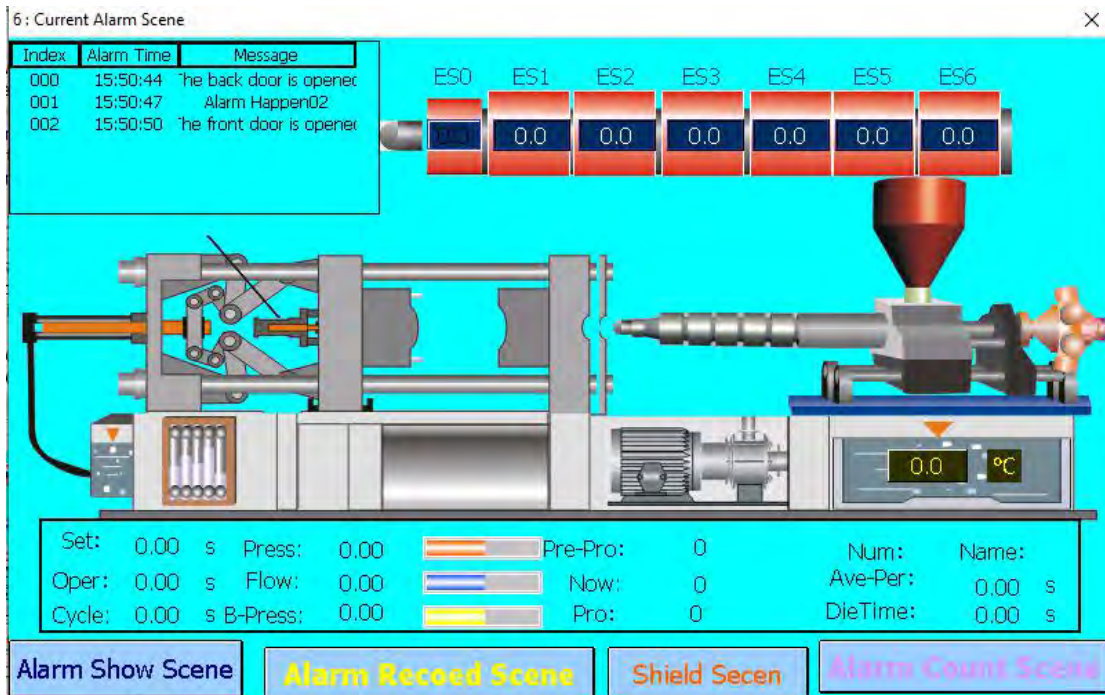

When selecting the alarm item in the [Current Alarm Table], the relative position of the fault alarm table will be displayed on the screen on the right side of HMI.

6: Current Alarm Scene ×

Index	Alarm Time	Message
000	15:50:44	The back door is opened
001	15:50:47	Alarm Happen02
002	15:50:50	The front door is opened

ES0

ES1

ES2

ES3

ES4

ES5

ES6

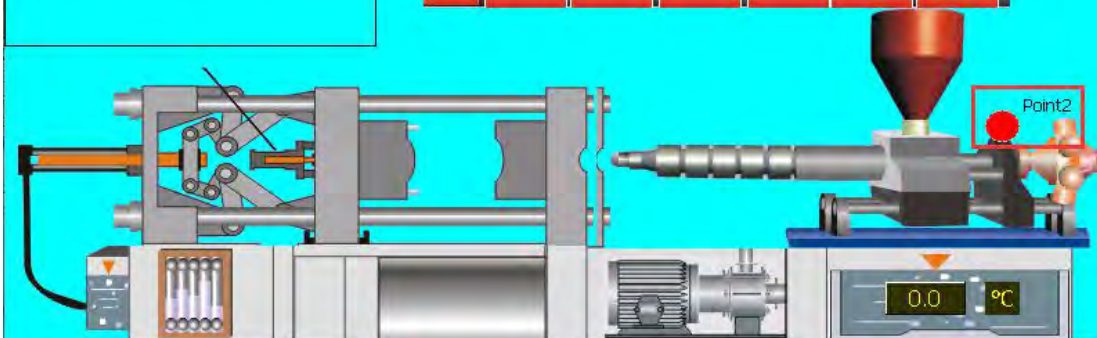

Set: 0.00 s	Press: 0.00	Pre-Pro: 0	Num: Name:
Oper: 0.00 s	Flow: 0.00	Now: 0	Ave-Per: 0.00 s
Cycle: 0.00 s	B-Press: 0.00	Pro: 0	DieTime: 0.00 s

Alarm Show Scene
Alarm Recored Scene
Shield Secen
Alarm Count Scene

6: Current Alarm Scene ×

Index	Alarm Time	Message
000	15:50:44	The back door is opened
001	15:50:47	Alarm Happen02
002	15:50:50	The front door is opened

ES0

ES1

ES2

ES3

ES4

ES5

ES6

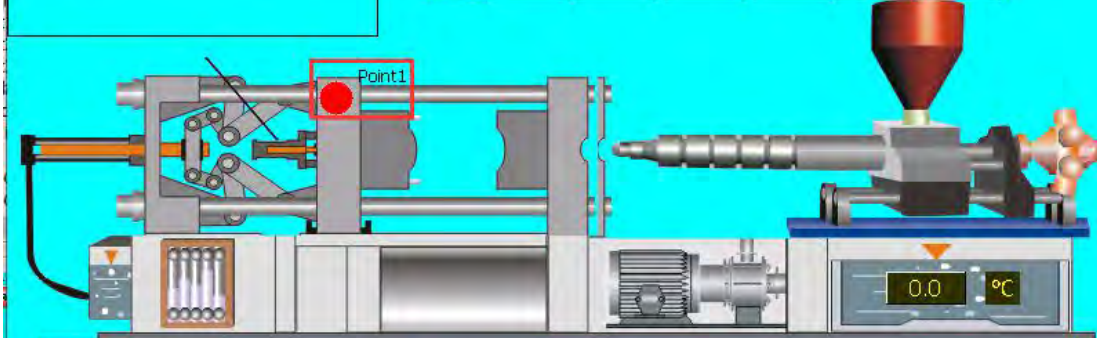

Set: 0.00 s	Press: 0.00	Pre-Pro: 0	Num: Name:
Oper: 0.00 s	Flow: 0.00	Now: 0	Ave-Per: 0.00 s
Cycle: 0.00 s	B-Press: 0.00	Pro: 0	DieTime: 0.00 s

Alarm Show Scene
Alarm Recored Scene
Shield Secen
Alarm Count Scene

## Chapter 7 Password Management

When operating the equipment, it is often necessary to provide users in different responsibilities with operating functions of different permissions. Some important functions are only available to users who have a password and have sufficient permissions. In this regard, password management provides protection layer and convenience in rights management.

Click [Project]-> [Password] to open the password edit form, as shown in the figure below. This software provides 8 sets passwords and 8 types permission levels for users to set. The first set of systems enforces the highest permissions to avoid insufficient permissions when setting incorrectly.

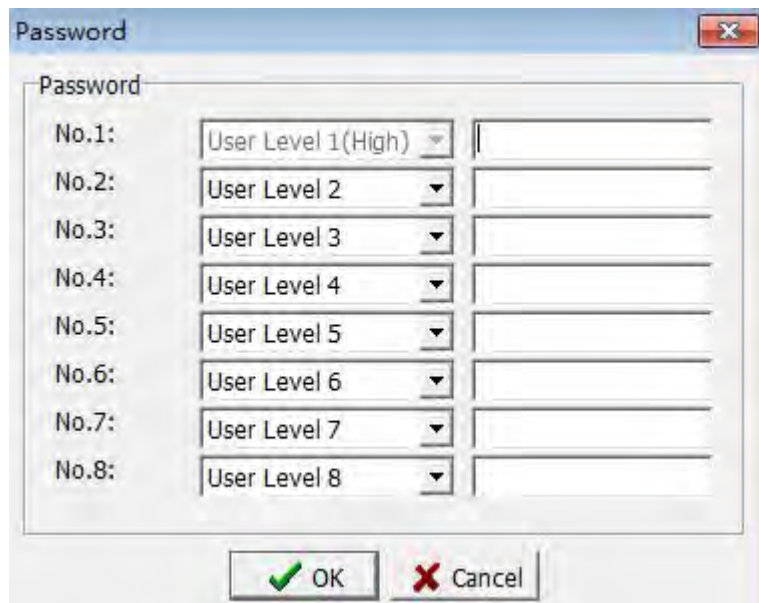

No.	User Level	Password
No.1:	User Level 1(High)	
No.2:	User Level 2	
No.3:	User Level 3	
No.4:	User Level 4	
No.5:	User Level 5	
No.6:	User Level 6	
No.7:	User Level 7	
No.8:	User Level 8	

Generally, the default level of the new added screen is [set by screen group], the default level of the screen group is the lowest authority, and the default level of all components is [set by screen]. Therefore, unless otherwise specified, the user can use all the functions of the editing, because all functions are available at the lowest level of authority.

### 7.1 Component setting

If some users needs to be restricted to a certain component ( button component & editing component), you can set the use permission of this component when setting the component. As shown in the figure below, set the usage permission of [Screen Button] to [User level 4].



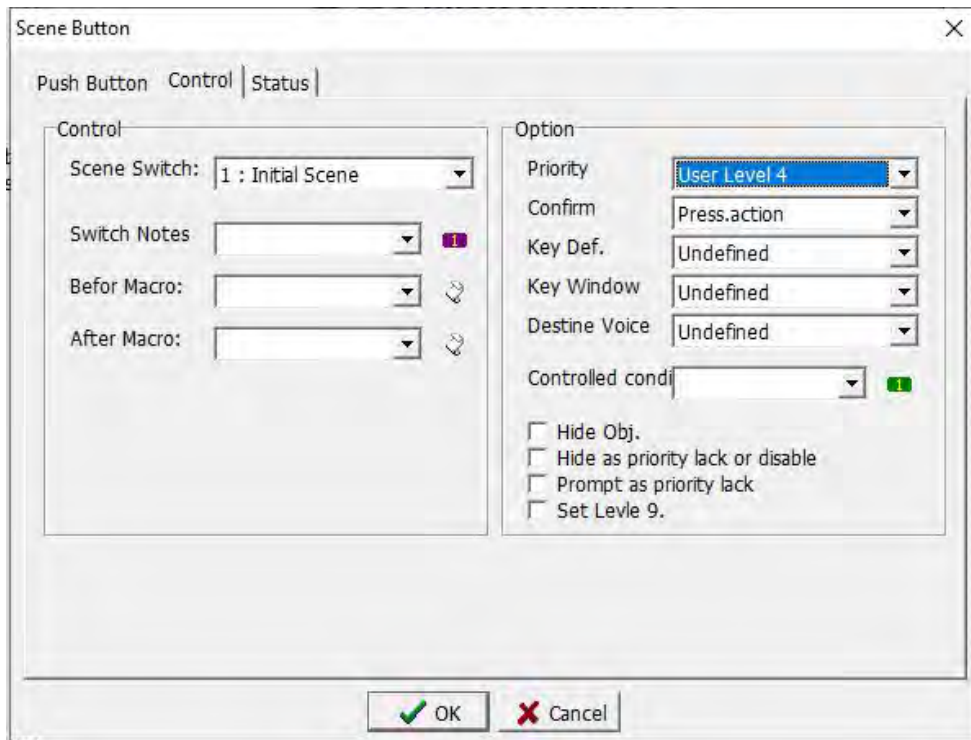

When using this button, the authority is lower than the setting authority, the password input screen will be shown as below, requiring the correct password before continuing to use this function.

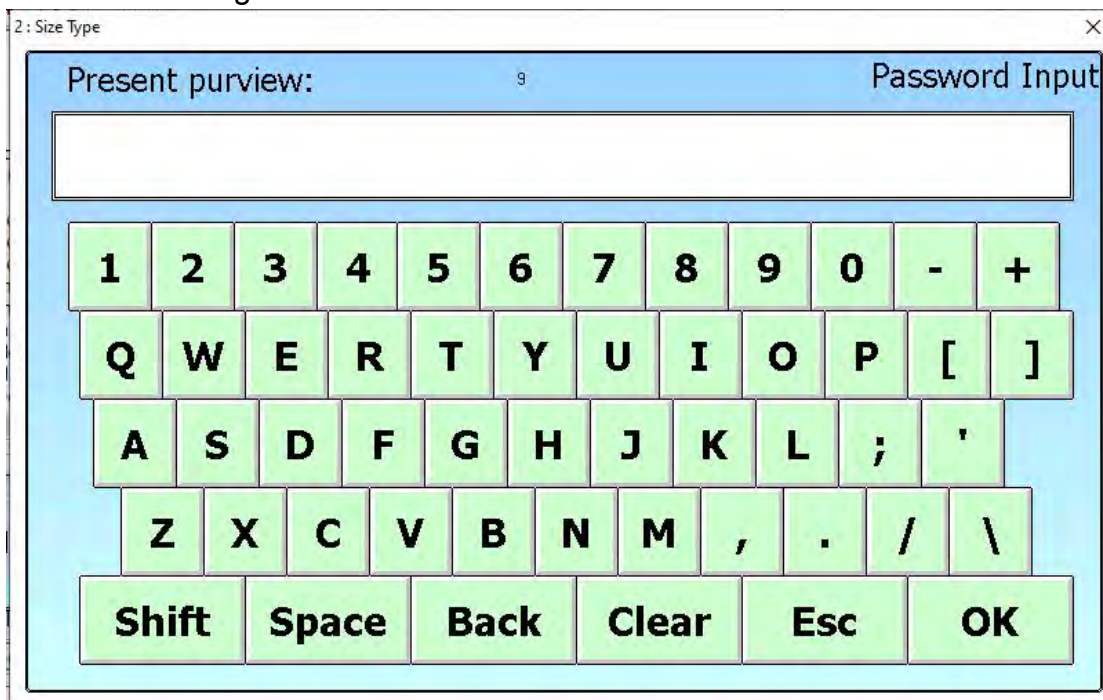

## 7.2 Screen settings

If you need to restrict the user to the components of the entire screen, you can set the use Screen Property when editing the screen, and are restricted by the

settings when using the screen component. The settings are shown below.

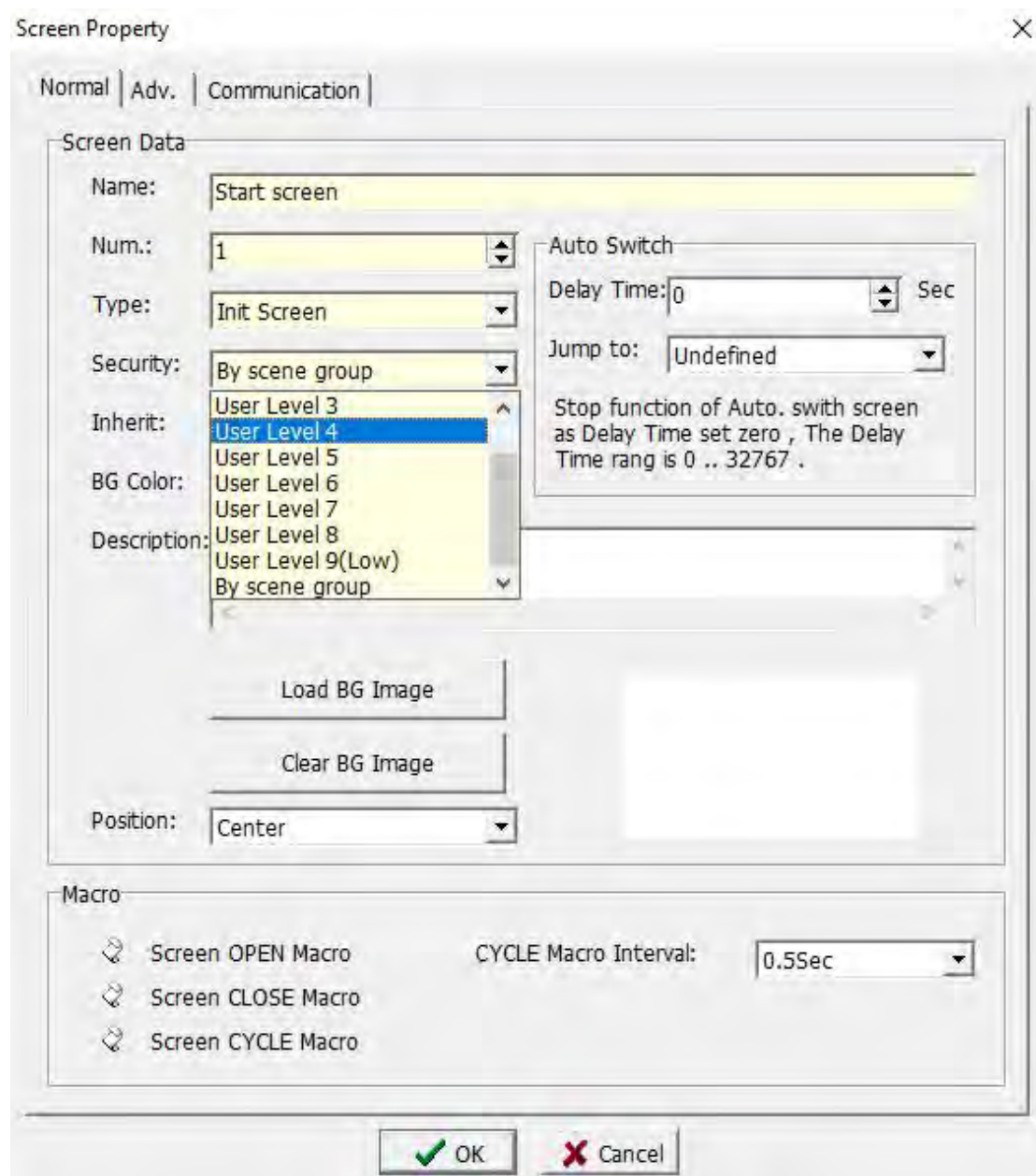

### 7.3 Password screen setting

In addition to planning the HMI project, you can edit the password to be used in [Project]-> [Password Management], or you can design a password page specifically for password management in the man-machine interface project. Show. The input element is [Password Edit] in [Edit].





[Password Edit] The property setting page is as below, you can choose to set several groups of passwords. Only the first group of passwords, that is, the password with the highest authority, cannot be set and needs to be set during project planning.

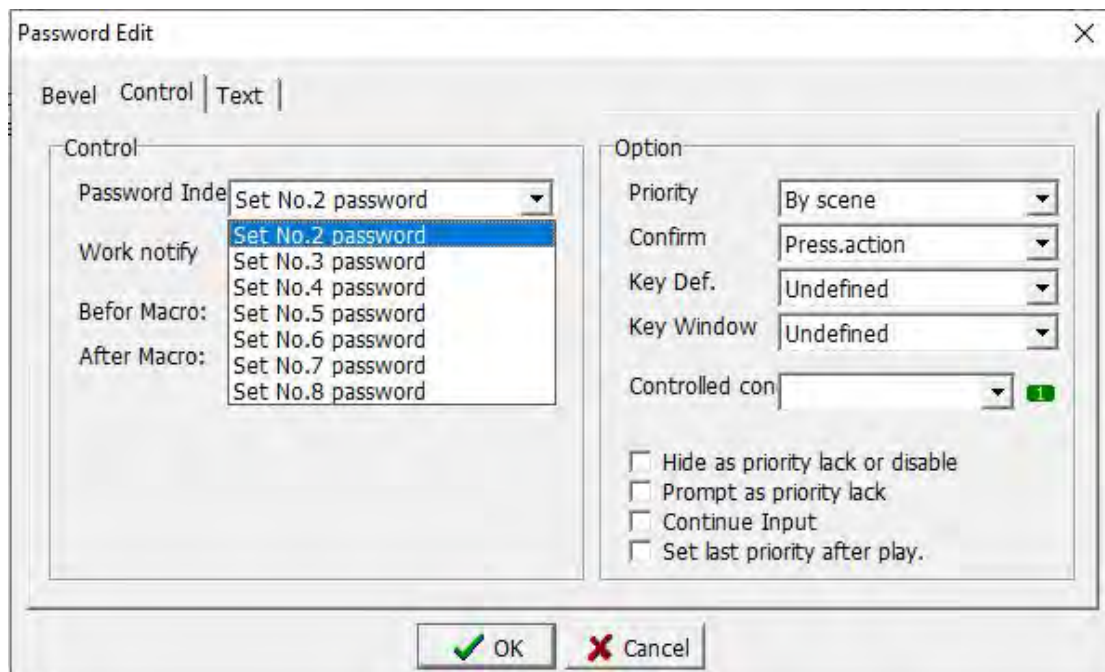

## Chapter 8 Sound Management

In this software, users are allowed to edit various sound effects to use, click [Project]-> [Sound Management] to open the sound management window, as shown below.

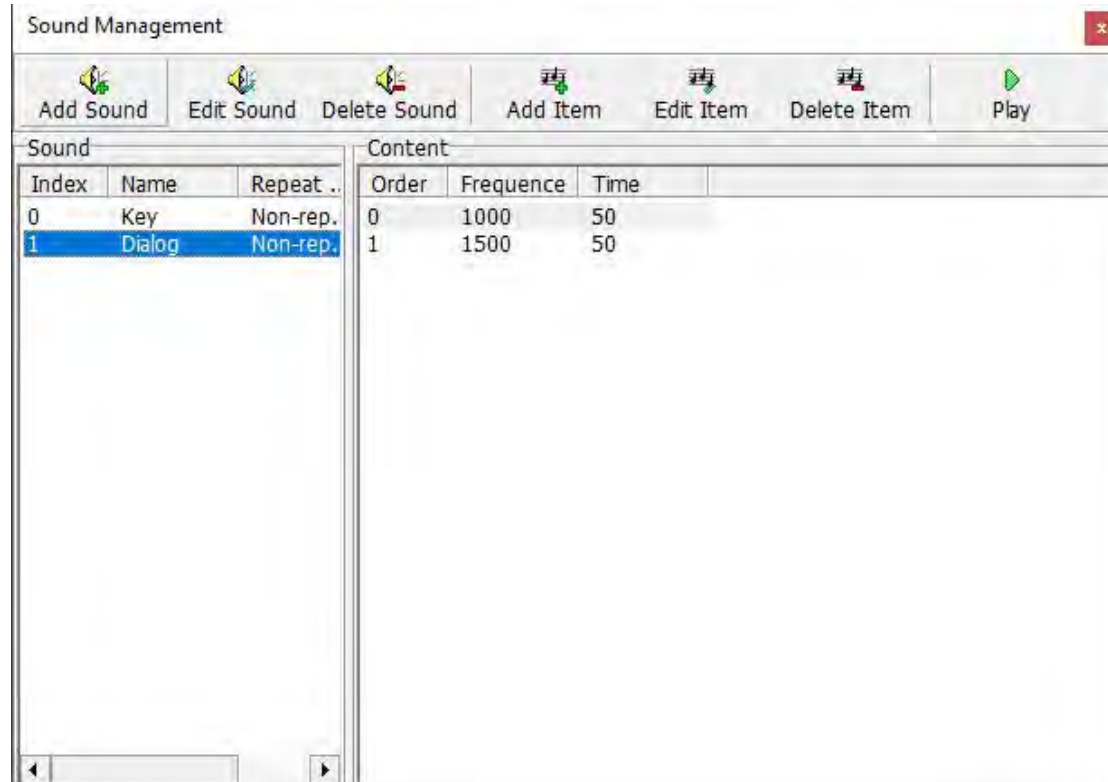

The part in the circle above is the sound preset by the system. By default, the system sets the index 0 and index 1 in the figure as the sound of the button and the dialog box.

Click the [Add Sound] button, and the [Add Sound Window] as shown below will pop up.

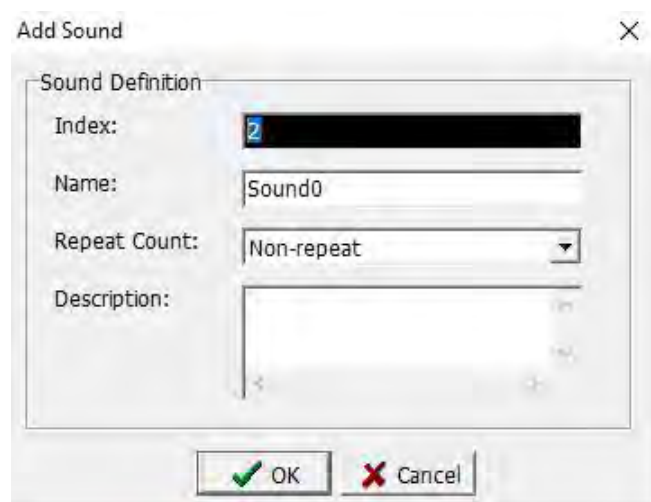

Index: The system automatically adds the index value in sequence.

Name: Enter the name defined for this sound.

Repeat Count: choose the number of repetitions when using this sound, you can choose not to repeat up to 7 times.

Description: Enter a help description for this sound.

After setting, click [OK] button to save the above settings. Click the [Add Item] button, and the [Add Sound Item] as shown below will pop up.

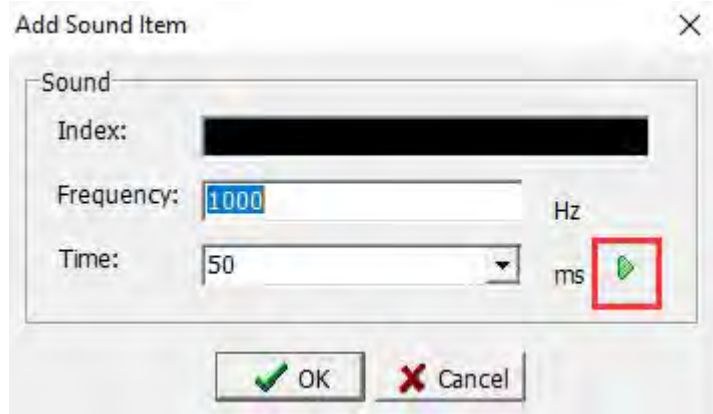

Frequency: Input the frequency of sound. The high and low sound will change with the frequency. The high frequency means sharp sound, and the low frequency means low sound. For the setting of sound frequency, please refer to [Appendix 3 Scale Frequency Table]

Time: Enter the time to make a sound, in ms, 500ms is equal to 0.5s, indicating that the sound will stop after 0.5 seconds.

The triangle button in the circle in the figure is the function of trying to play the sound. After setting the sound frequency and duration, you can press this button to play to confirm whether it is the sound you want to set.

This completes the setting of each parameter of sound. In the process of setting the attributes of components, if there is a demand for sound, you can choose to use it, as shown in the following figure.

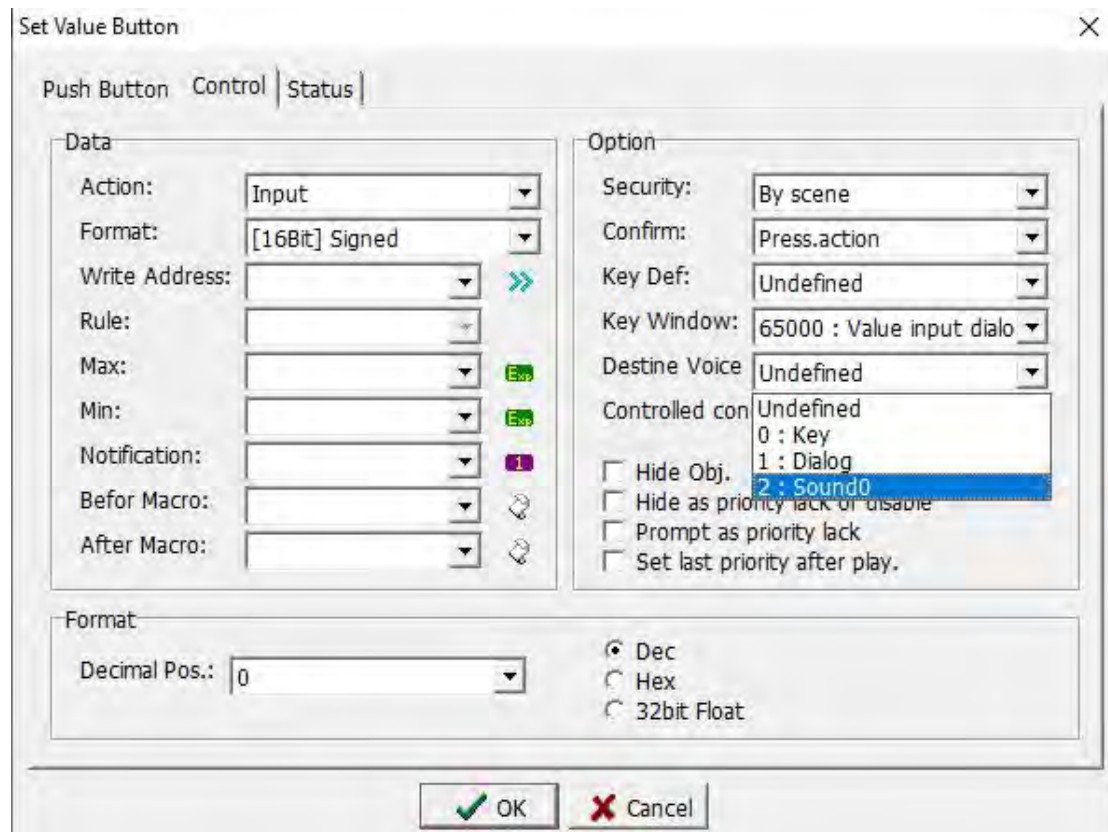

## Chapter 9 Data Synchronization Management

When the device is actually running, there are some materials that need to be updated synchronously, or when you need to use one data to affect another data, you can use [Data Sync] to complete.

Click [Project]-> [Data Sync...] to open the [Data Sync] Window, as shown in the figure below.

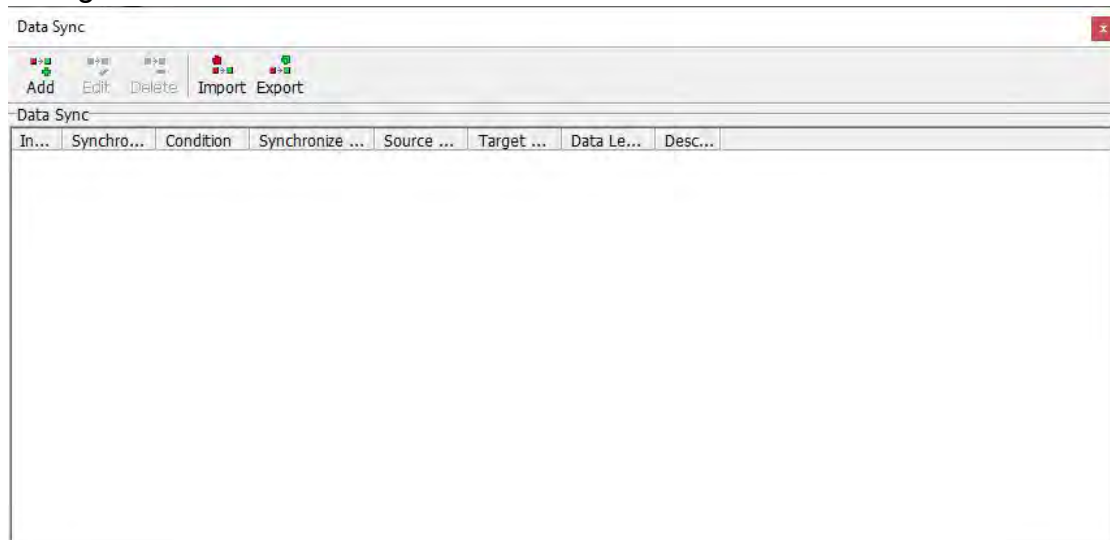

Click the [Add] button to open the [Add Data Sync] window as shown below. You can edit the data to be synchronized.



Add Data Sync. X

Data Sync

Time: 3Sec

Format: [16Bit] Signed

Condition: 1 Exp

Type: High Level

Data Type: [16Bit] Unsigned

Source: N0 Exp

Destination: N1 >>

Length: 1

Write multiple data at once

Description:

OK Cancel

**Time:** Select the time to achieve synchronization, that is, when the data of the source address changes, how long the data of the destination address will be synchronized after the condition variable reaches. In other words, the time when the synchronization condition is valid. For example, synchronization condition mode: high level; condition variable: N10.0; synchronization time: 10 minutes; then N10.0==1 after 10 minutes, the data starts to synchronize, if it is a falling edge, then the condition must be maintained More than 10 minutes, otherwise the falling edge cannot be detected, so there is no special requirement. Generally set the synchronization time of 0.2 seconds (that is, the trigger condition is very sensitive, and the condition variable is synchronized immediately).

**Format:** select the type and type of variable used for synchronization data.

**Condition:** Set the condition variable and decide whether to synchronize according to the synchronization condition mode of this condition variable.

**Type:** In this case, the high level is set to achieve synchronization.

**Rising edge:** When the data changes from 0 to 1, synchronization is achieved.

**Falling edge:** When the data changes from 1 to 0, synchronization is achieved.

**Rising and falling edges:** When the data changes from 0 to 1 or from 1 to 0,

both are synchronized.

Positive level: when the data is 1, synchronization is achieved.

Negative level: when the data is 0, synchronization is achieved.

Source: Set the address of the data source, that is, the address where the data is read. In this case, the system variable N0 is used.

Destination: Set the address of the data destination, that is, the address where the data is written. In this case, the system variable N1 is used.

Description: Enter the definition description for this synchronous data, you can not enter it.

After the above parameter setting is completed, the editable synchronization screen can be edited. This screen changes the value of N0 by the increment and decrement buttons. After the value of N0 changes for 3 seconds, the value of N1 changes to the same value as N0. Show.

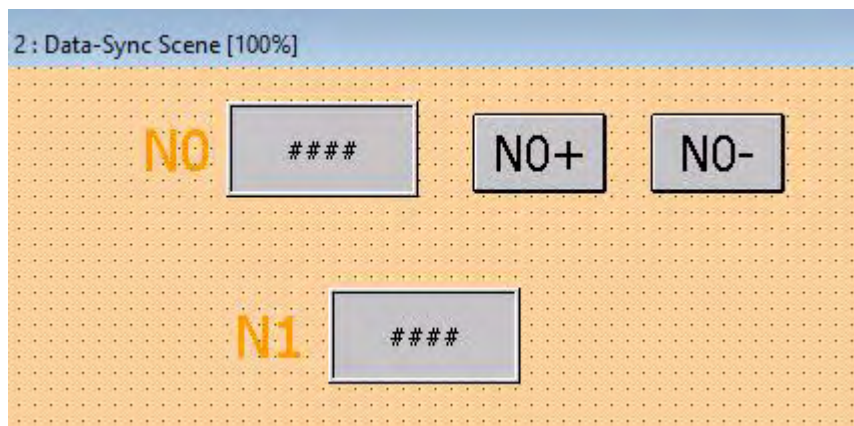

: Data-Sync Scene

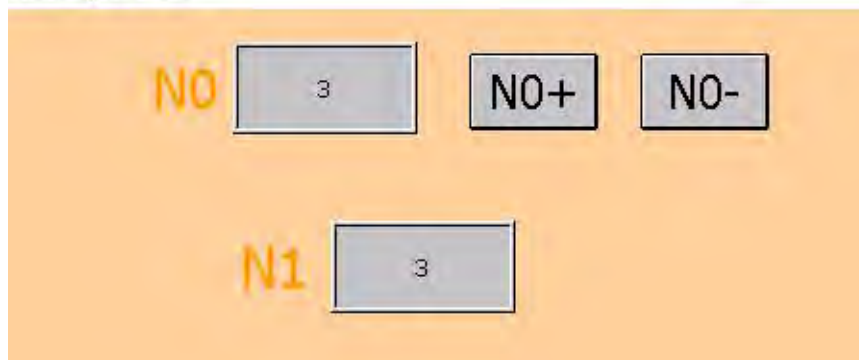

## Chapter 10 Recipe Management

When the HMI is connected to the PLC, there are often a large number of values with the same nature of the data that need to be transmitted. We categorize and sort these data and transmit them at the same time. This is the recipe. When the general equipment is in actual operation, there are some production materials that need to be transmitted to the PLC by the man-machine interface, or when the man-machine interface is required to record the data, you can use [Recipe] to achieve.

Click [Project]-> [Recipe] to open the [Recipe] Management Window, as shown below.

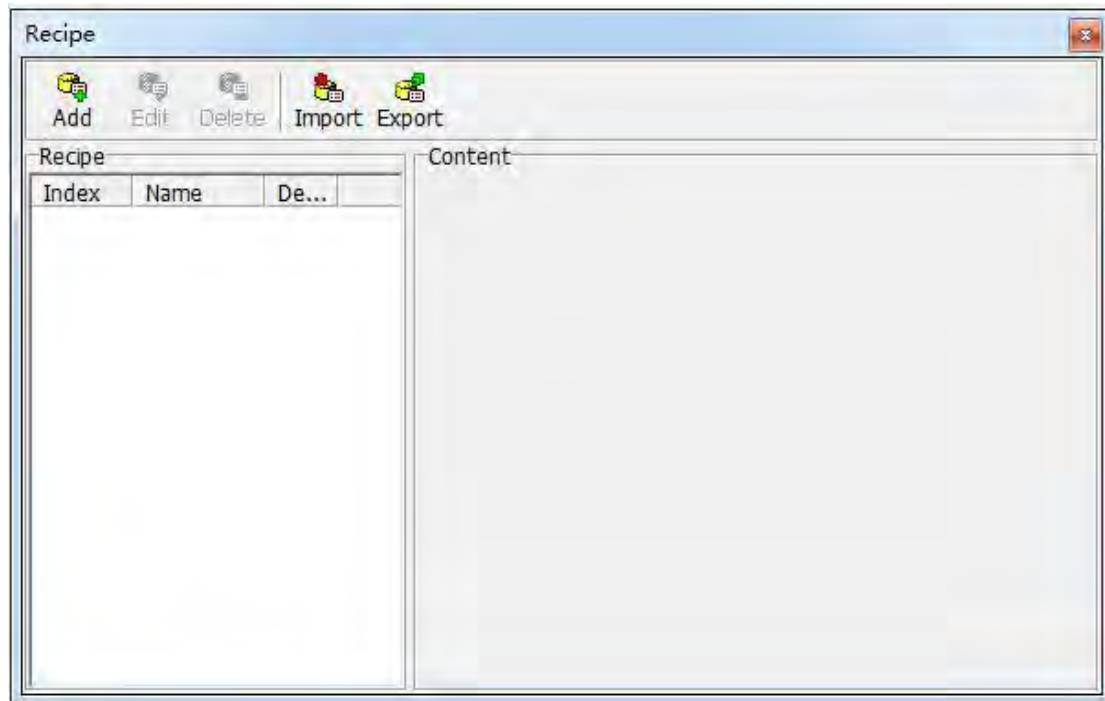

Click the [Add] button to open the [Add Recipe] Definition Window, as shown in the figure below, you can edit the new recipe data .

**Index:** The system automatically adds the index value of the recipe data in sequence.

**Name:** Set the name of the recipe.

**Work:** Use the recipe to temporarily store the starting address of the corresponding variable (the size is 1 group recipe capacity).

**Control:** variable address that controls the recipe action (the size of the control area is 4 WORD)

Addresses	Name	Content	Remarks
+0	Index0	0..65535	
+1	Rev	0	Keep
+2	Rev	0	Keep
+3	Control	Bit0=Read(Move from backup area to work area) Bit1=Write(Move from backup area to work area)	Automatically cleared after moving parts

**Backup Addr:** Choose recipe backup, currently only 2 options are available.

**Data read-only:** data is stored in the HMIT program, suitable for read-only recipes.

**Use system variable area (N0-N61439):** data is stored in the system variable area, suitable for reading and writing recipes.

**Remarks:** For the system variable area, please check the power failure holding section of individual models.

**Backup Addr:** The storage address of the backup recipe.

Recipe Count: The total number of recipe groups.

Description: Enter the description text of this recipe, you can not enter it.

Formula variable definition:

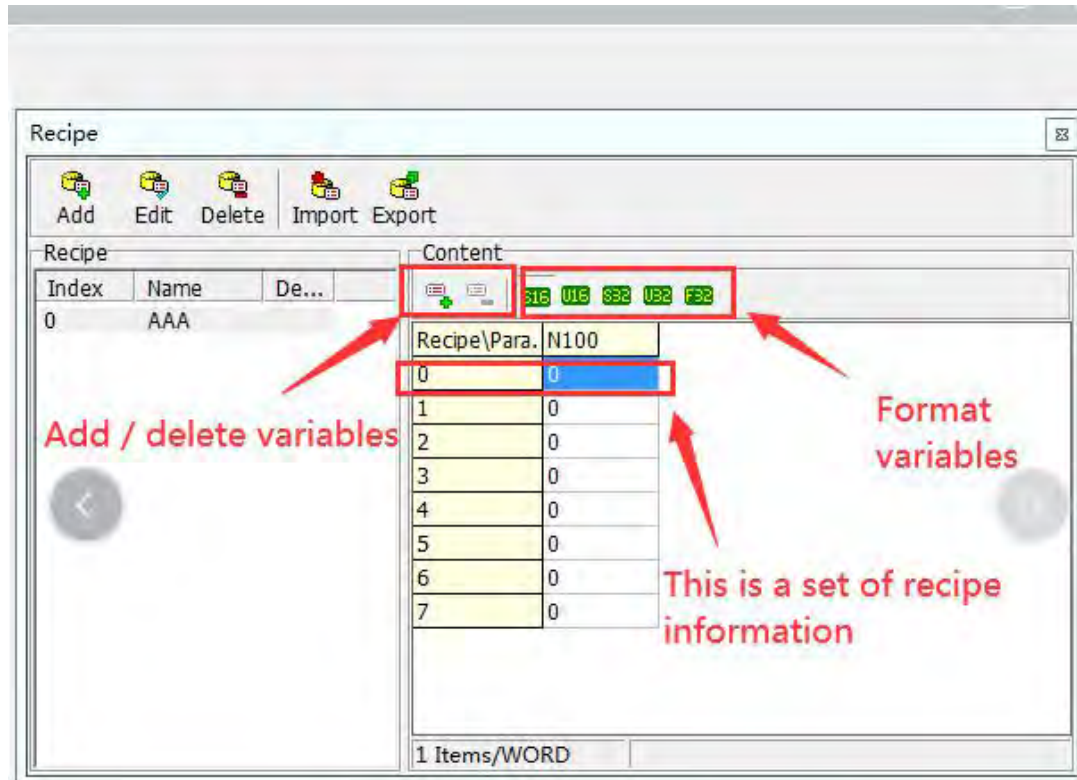

**Add / Delete Variables:** Click the Add / Delete button directly to add / delete variables.

**Set variable format:** Click any column that needs to modify the variable format, and then click the corresponding variable format required by this column.

S16: Set to 16-bit signed number.

U16: Set to 16-bit unsigned number.

S32: Set to 32-bit signed number.

U32: Set to 32-bit unsigned number.

F32: Set to 32-bit floating point.

**Definition of recipe variables:** Recipe actions are controlled by reading and writing variables in the control area.

**Read recipe action::**

Address	Name	Content
+0	Index0	0
+1	Rev	0
+2	Rev	0
+3	Control	Set 1(Bit0: Move from backup area to work area)

Move the group 0 recipe from the backup area to the work area

**Write recipe action:**



Address	Name	Content
+0	Index0	7
+1	Rev	0
+2	Rev	0
+3	Control	Set 2(Bit1: Move from backup area to work area)

Moved from group 0 recipe in working area to group 7 in backup area.

In addition, in order to write the recipe into the controller PLC or read it out from the same controller PLC, it is necessary to match the data movement button component, as shown in the figure below.

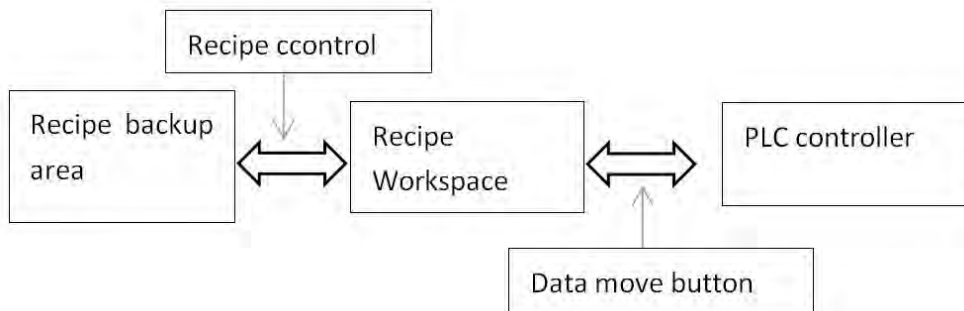

## 10.1 Recipe use cases

This case is used to explain how to set the usage data recipe.

Step 1. Click [Project]-> [Recipe] on the menu bar to open the [Recipe] Management Window, as shown in the following figure:

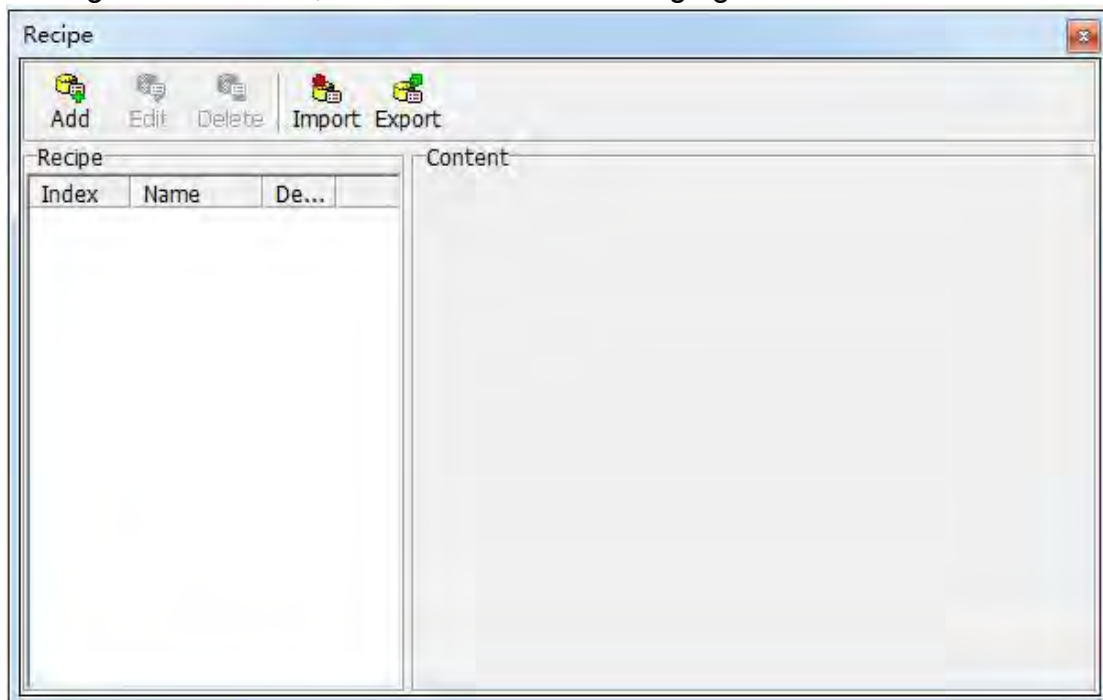

Step 2. Click the [Add Recipe] button to open the [Add Data Recipe Definition] window and enter each parameter value, as shown in the following figure.

Recipe

Index: [REDACTED]

Name: AA

Work: N10

Control: NO

Backup Device: Used Internal Memory(N0-N61439)

Backup Addr.: N100

Recipe Count: 8

Description:

OK Cancel

Step 3. After setting the parameters, click the [OK] button to return to the [Recipe] Management window. The newly added recipe data is displayed on the right side of the window, as shown in the following figure.

Recipe

Add Edit Delete Import Export

Index	Name	De...
0	AA	

Recipe\Para.	N10
0	25
1	26
2	89
3	75

1 Items/WORD Save addr.:N53

Step 4. Click the [Add] Recipe Variable button , add the recipe variable to N13, and enter the numerical value of the recipe, as shown in the following figure.

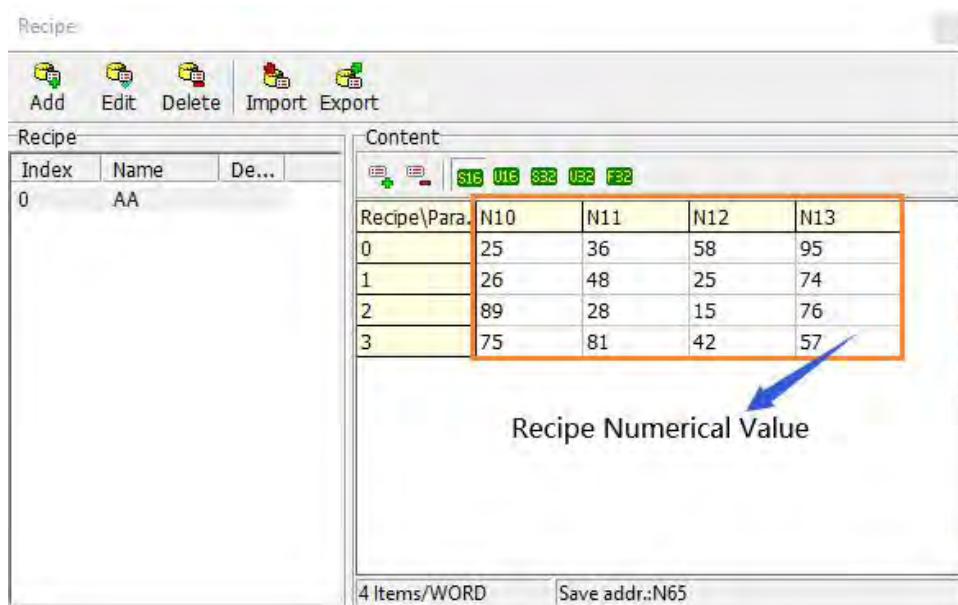

Step 5. Close the [Recipe] window, return to the project editing screen, and add the numeric editing elements in the work area addresses N10 ~ N13, as shown in the figure below.

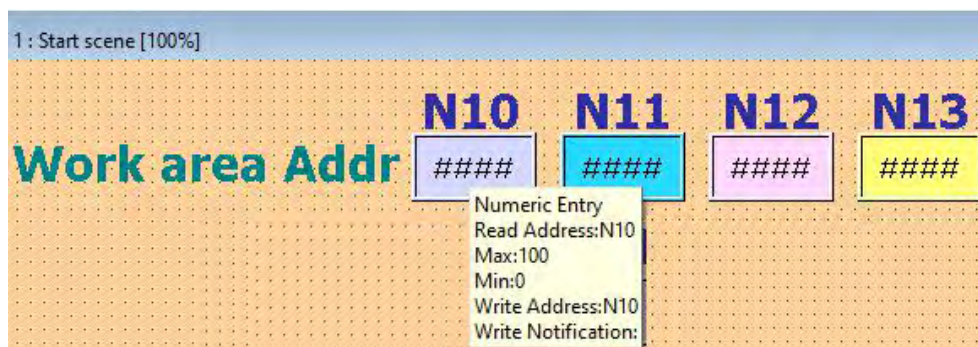

Step 6. Add the numeric display elements of backup addresses N100 ~ N123. Generally, it is not necessary to plan the editing of this part during the actual operation. As shown below.



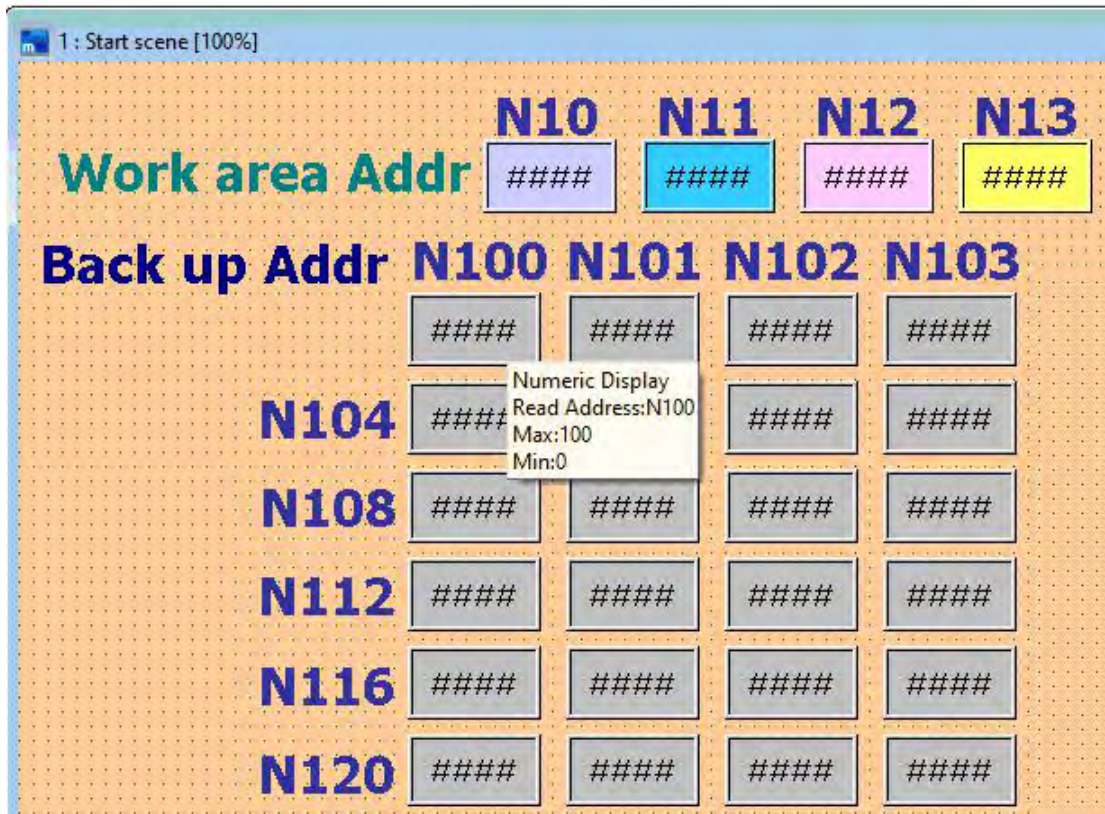

Step 7. Add a numeric editing component for the number of recipe groups, which can be used to read and write the number of specified recipe groups. The format is shown in the figure below.

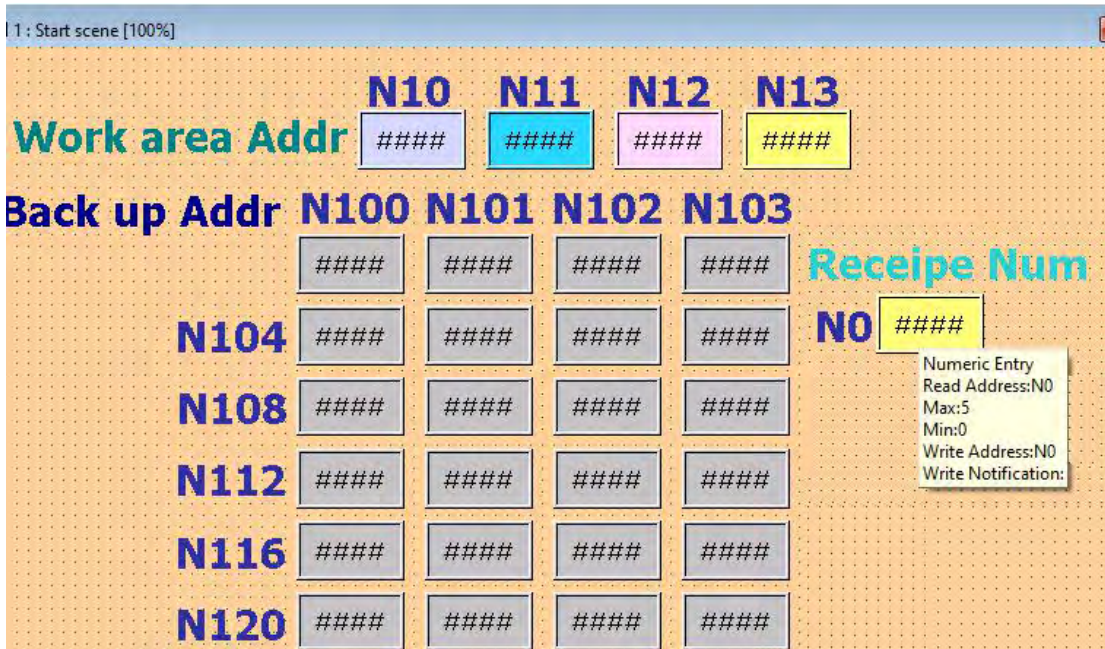

Step 8. Add an ON button component, which is used as recipe data to write into the backup address of the specified recipe group number from the work area address, and its variable position is input as N3.1, as shown in the figure below.



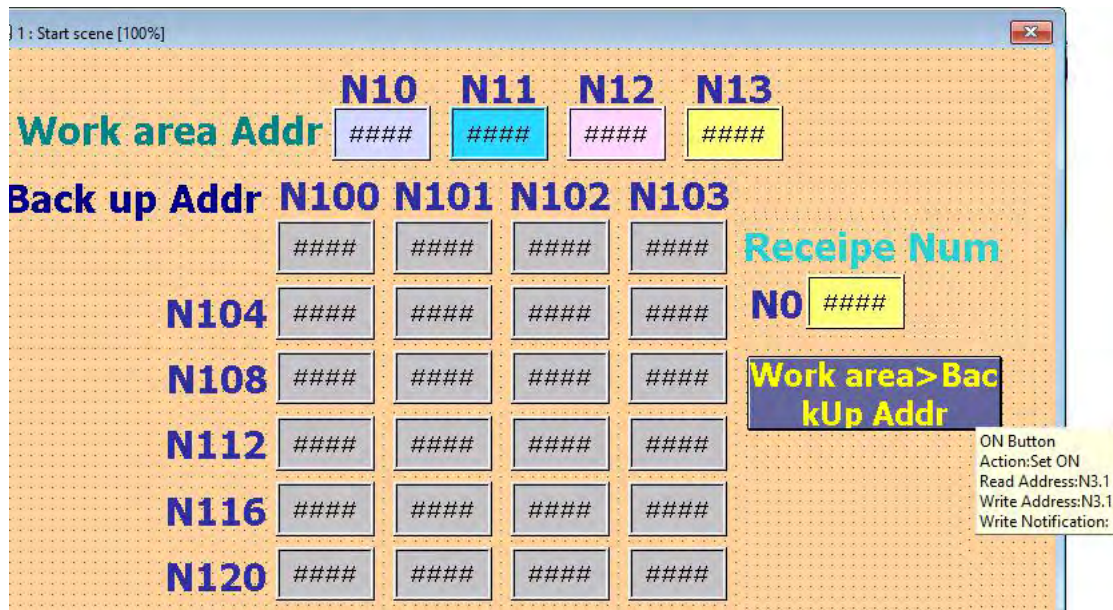

Step 9. Add an ON button component written back to the storage area, which is used as recipe data to read from the backup address of the specified recipe group number to the work area address, and enter N3.0 as the variable position, as shown in the following figure.



Step 10. The screen editing settings are completed, at this time click the menu option [HMI]-> [offline execution], the execution screen as shown in the figure below appears.





Step 11. Enter 3 in the recipe group number edit box and press [Backup Addr-> Work area] to write the third group of recipe data from the backup address to the work area address, as shown in the figure below.



Step 12. Change the value in the formula group number edit box to 4, and then modify the value of each recipe in the work area. After modification, press [Work Area-> Backup Address] to read out the recipe data in the work area address to The fourth group of backup addresses is shown below.



Step 13. The use of general recipes must be matched with the PLC register, so the numerical editing components of PLC positions D0 ~ D3 are added as shown in the figure below.

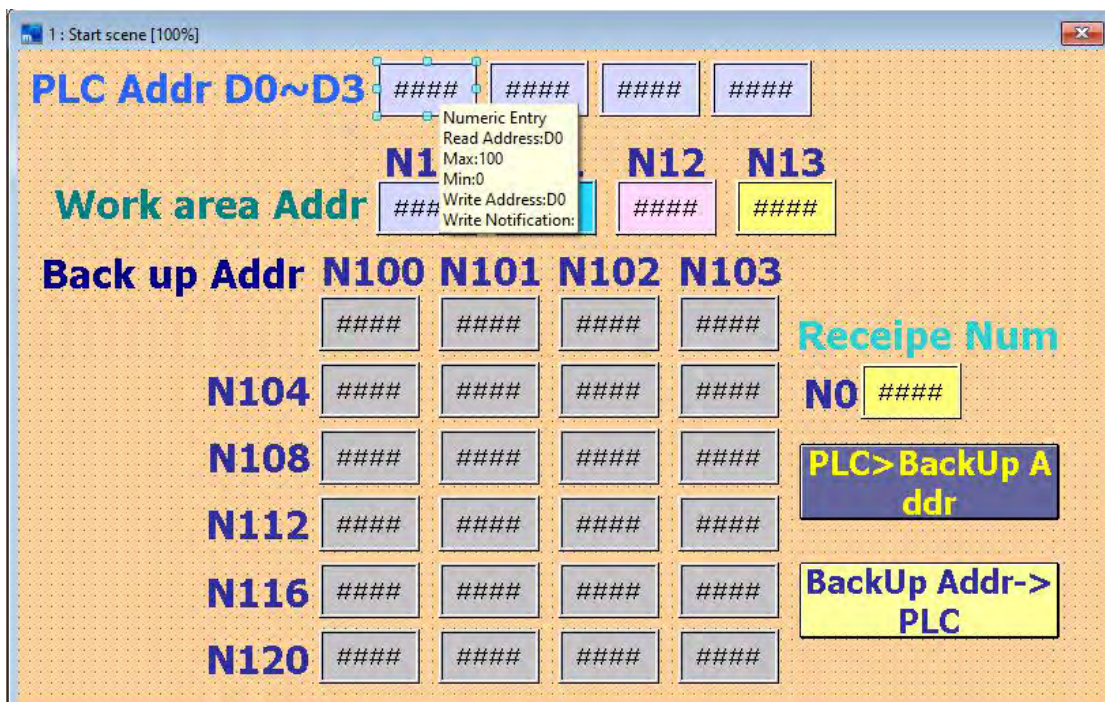

Step 14. Click [Project]-> [Data Synchronization Management] in the menu bar to add 2 data synchronization from [PLC-> Working Area] and [Working Area-> PLC], as shown in the figure below, more details please refer to Chapter 9.



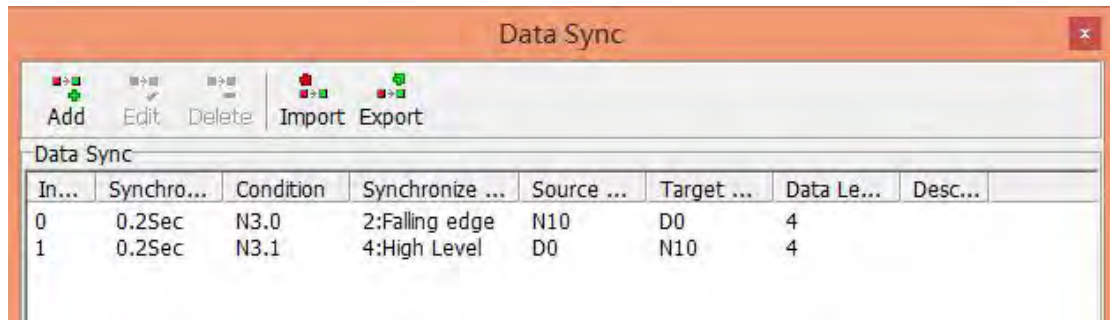

Step 15. Modify the two ON buttons on the edit screen as shown below.

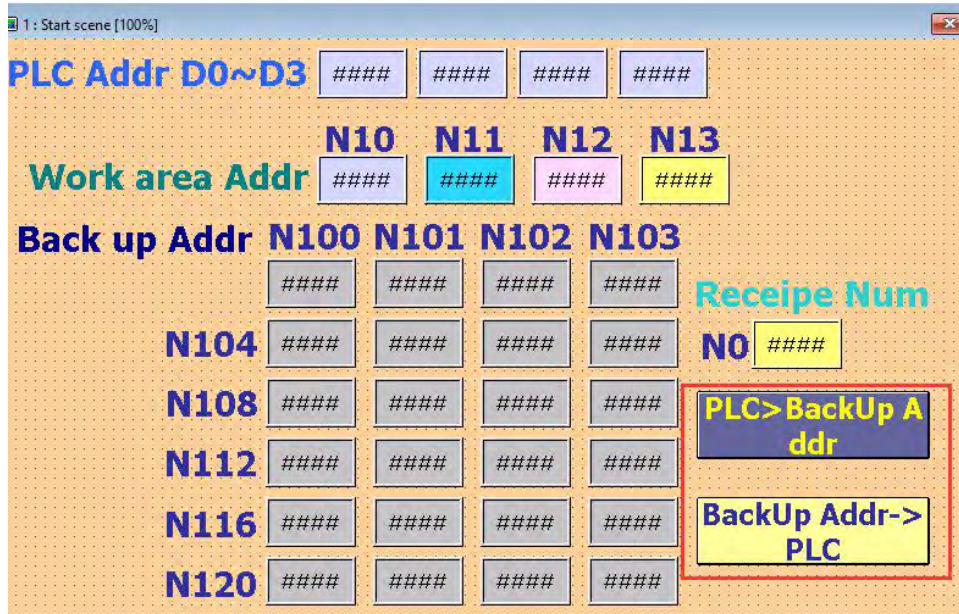

Step 16. Click the menu option [HMI]-> [Off-Line Run], the execution screen is as shown in the figure below.

1: Start scene

✕

<b>PLC Addr D0~D3</b>				0	0	0	0
<b>Work area Addr</b>				N10	N11	N12	N13
				0	0	0	0
<b>Back up Addr</b>				N100	N101	N102	N103
				25	36	58	95
<b>N104</b>	26	48	25	74	<b>Receipe Num</b>		
<b>N108</b>	89	28	15	76	<b>NO</b>	0	
<b>N112</b>	75	81	42	57	<b>PLC&gt;BackUp A ddr</b>		
<b>N116</b>	0	0	0	0	<b>BackUp Addr-&gt; PLC</b>		
<b>N120</b>	0	0	0	0			

Step 17. At this time, click the number of recipe groups to enter 2, and then click [Backup Addr-> PLC], the recipe data of the third group can be read from the backup address area to the PLC address, as shown in the figure below.

1: Start scene

✕

<b>PLC Addr D0~D3</b>				89	28	15	76
<b>Work area Addr</b>				N10	N11	N12	N13
				89	28	15	76
<b>Back up Addr</b>				N100	N101	N102	N103
				25	36	58	95
<b>N104</b>	26	48	25	74	<b>Receipe Num</b>		
<b>N108</b>	89	28	15	76	<b>NO</b>	2	
<b>N112</b>	75	81	42	57	<b>PLC&gt;BackUp A ddr</b>		
<b>N116</b>	0	0	0	0	<b>BackUp Addr-&gt; PLC</b>		
<b>N120</b>	0	0	0	0			

Step 18. Modify the number of recipe groups, enter 1, change the data in the PLC location D0 ~ D3, and then click [PLC-> Backup address], the recipe data in the PLC location can be written to the third group backup address, as shown below.

1: Start scene ×

<b>PLC Addr D0~D3</b>	66	77	88	99	
	<b>N10</b>	<b>N11</b>	<b>N12</b>	<b>N13</b>	
<b>Work area Addr</b>	66	77	88	99	
<b>Back up Addr</b>	<b>N100</b>	<b>N101</b>	<b>N102</b>	<b>N103</b>	
	25	36	58	95	
<b>N104</b>	66	77	88	99	<b>Receipe Num</b>
<b>N108</b>	89	28	15	76	<b>NO</b> <span style="border: 1px solid red; padding: 2px;">1</span>
<b>N112</b>	75	81	42	57	<b>PLC&gt;BackUp A ddr</b>
<b>N116</b>	0	0	0	0	<b>BackUp Addr-&gt; PLC</b>
<b>N120</b>	0	0	0	0	



## Chapter 11 Macro Types and Grammar

### 11.1 Types of macros

#### INITIAL macro

Macro command that starts when the HMI is powered on or restarted. This macro instruction is executed only once, and is generally used for setting the initial value. By default, it can execute 4096 steps.

#### BACKGROUND Macro

After the HMI is powered on or restarted, the program will be executed all the time. Similar to the background program, 1024 steps can be performed by default 50ms.

#### CLOCK macro

After the HMI is powered on or restarted, the program will be executed at intervals, and the interval is set to 500ms to execute 4096 steps.

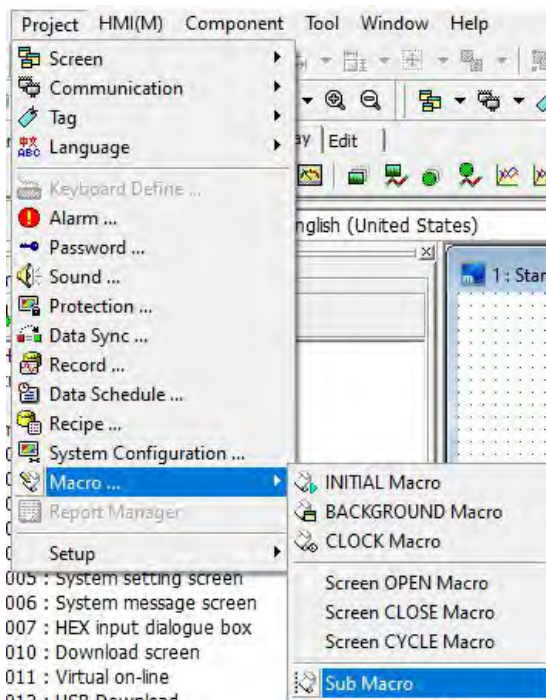

#### Screen Open Macro

When the screen is switched to the currently set screen, the OPEN macro program will be executed, and the default can perform 4096 steps at a time.

#### Screen Close Macro

When the current screen is switched to another screen, the CLOSE macro instruction program will be executed. By default, it can perform 4096 steps at a time.

### Screen Cycle Macro

When the screen is switched to the currently set screen, the CYCLE macro command program will be executed all the time. The interval time is preset to 500ms, and the preset can perform 4096 steps at a time.

Screen Property >

Normal | Adv. | Communication |

Scene Data

SceneName: Start Scene

SceneNum: 1

SceneType: Init Scene

Security: By scene group

Inherit: Undefined

BG Color:

Description:

Load BG Image

Clear BG Image

Position: Center

Auto Switch

Delay Time: 0 Sec

Jump to: Undefined

Stop function of Auto. swith screen as Delay Time set zero , The Delay Time rang is 0 .. 32767 .

Macro

Screen OPEN Macro      CYCLE Macro Interval: 0.5Sec

Screen CLOSE Macro

Screen CYCLE Macro

### Component action macro (button component and editing component)

When the button component or editing component is activated, the corresponding macro program will be executed. The preset can perform 4096 steps at a time.

**Set Value Button**

Button | Data | Status

**Data**

Action: Input

Format: [16Bit] Signed

Write Address: >>>

Rule: >

Max: > Exp

Min: > Exp

Notification: > !

Before Macro: > ↺

After Macro: > ↺

**Option**

Security: By scene

Confirm: Press.action

Key Def: Undefined

Key Window: 65000 : 数值输入对话框

Destine Voice: Undefined

Enable Provisol: > !

Hide Obj.

Hide as priority lack or disable

Prompt as priority lack

Set last priority after play.

**Format**

Decimal Pos.: 0

Dec

Hex

32bit Float

OK Cancel

**Numeric Entry**

Bevel | Control | Text

**Control**

Data Type: [16Bit] Signed

Read Addr.: > Exp

Max: > Exp

Min: > Exp

Write Addr.: >>>

Write Notificat: > !

Before Macro: > ↺

After Macro: > ↺

**Option**

Priority: By scene

Confirm: Press.action

Key Def: Undefined

Key Window: 65000 : Value input dia

Controlled con: > !

Hide as priority lack or disable

Prompt as priority lack

Continue Input

Set last priority after play.

**Engineer Transfer**

Offset: 0

Gain: 1.0

Aux. Cal.

**Display Format**

Integer: 4

Decimal Pos.: 0

Decimal

Hex.

32 Bits Float. Point

Zero of Hi Bites

OK Cancel

### Sub Macro

The sub-macro instruction is equivalent to the sub-program in the macro instruction program. The number is provided from 1 to 512 sub-programs. Common and general functions can be written in the sub-program to facilitate the main program call.

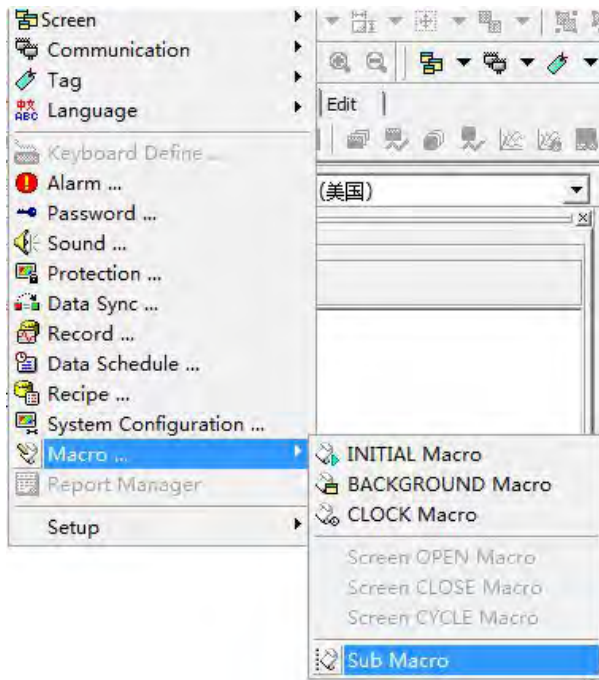

Among them, there are 16 groups of sub-macro 496-512, which are reserved for system use. Using Macro communication, when the communication receives data, the system will automatically execute [496: Sub Macro (496)] without calling it.

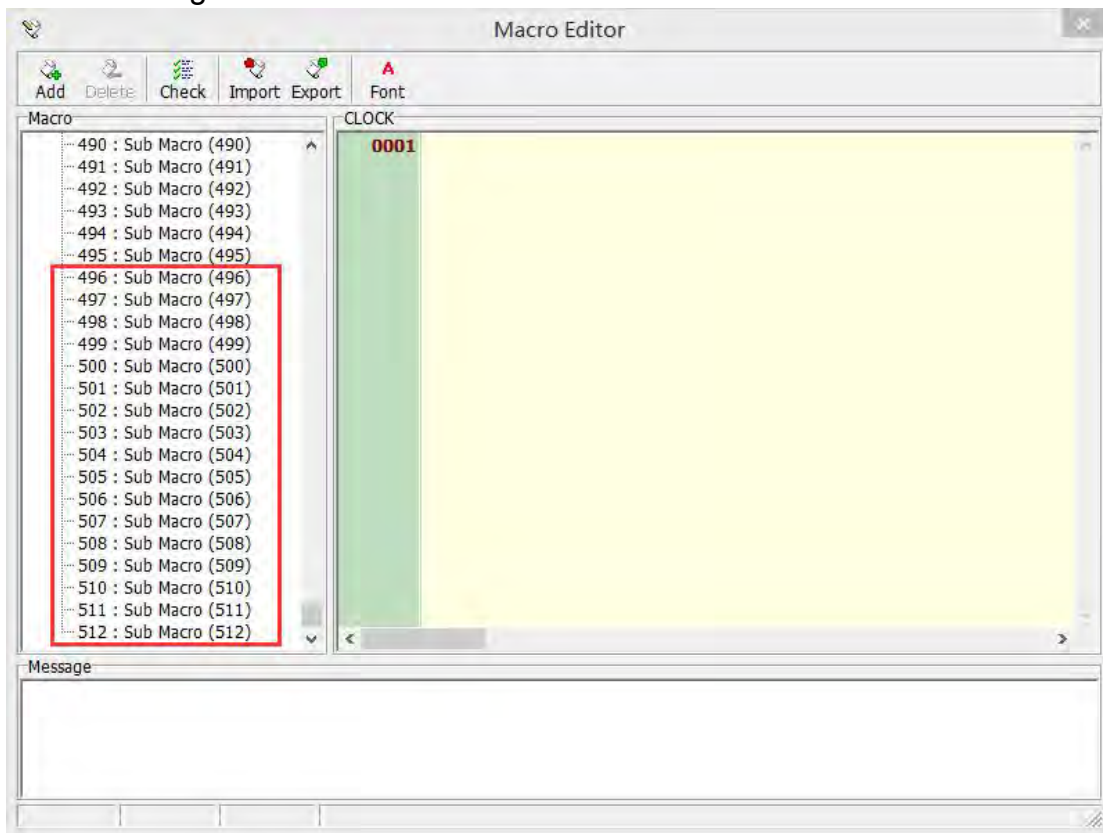

## 11.2 Macro Editor

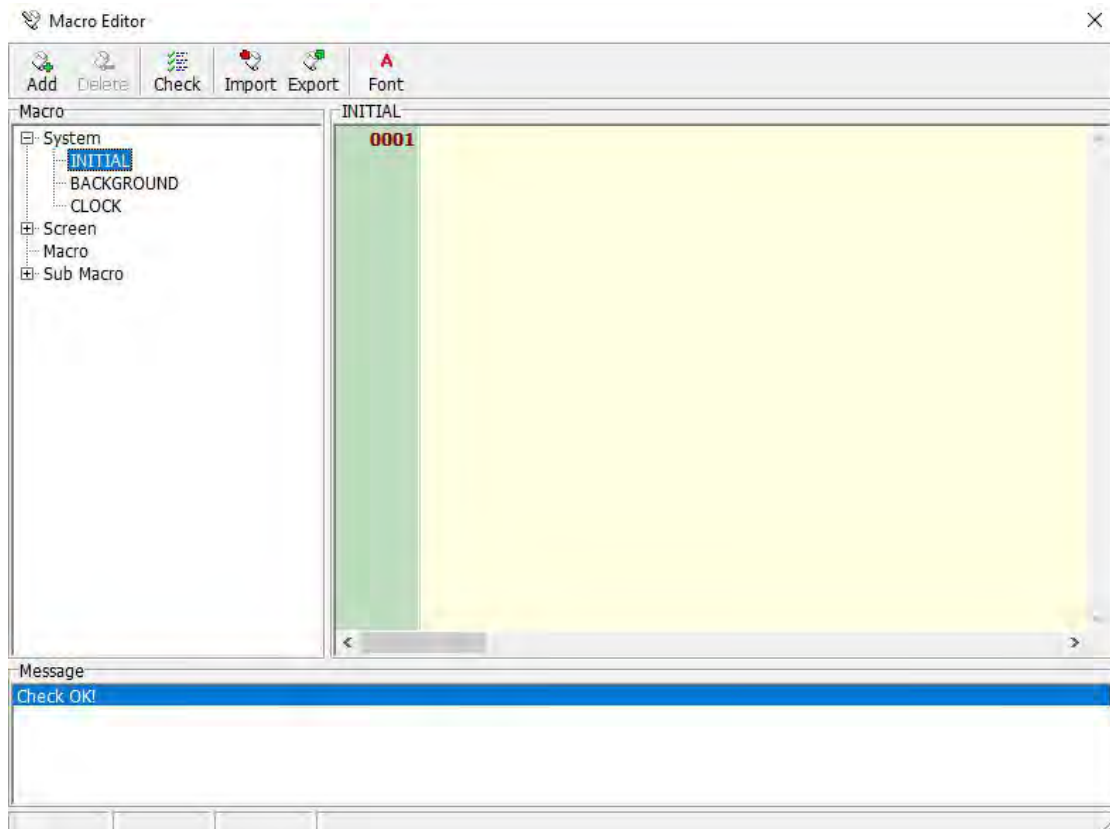

There is a toolbar at the top of the editing screen, with five options: add, delete, Check, Import and export.

Add: Add a component action macro.

Delete: delete a component action macro.

Check: Check the current macro program for errors.

Import: Imported from the project to the currently edited macro program, the current edited program will be cleared.

Export: Save the currently edited macro program to the project.

The left side of the editing screen provides a tree diagram of the macro program, which displays all the macro commands. It is convenient to edit and preview the macro program.

The right side of the editing screen is the main body of the editing program screen.

At the bottom of the edit screen is the check program information window. It will be displayed when the check program is executed. When the check finds a problem, it will be displayed in the window. Double-click the mouse at the displayed problem, the edit macro program screen will automatically jump To the corresponding program position.

## 11.3 Introduction to Macro Syntax

### 11.3.1 Data format, operator, command list



Data format setting table

format	Bit	8bit Signed number	8bit Unsigned number	16bit Signed number	16bit Unsigned number	32bit Signed number	32bit Unsigned number	32bit Floating point
definition	BIT	INT8S	INT8U	INT16S or SIGNED	INT16U	INT32S or SIGNED DW	INT32U or DW	FLOAT32 or FLOAT

Set operator column table

Set operator	Explanation
=	Setting
+=	Addition settings
-=	Subtraction setting
*=	Multiplication setting
/=	Division setting
%=	Integer remainder setting
<<=	Left shift setting
>>=	Right shift setting
&=	Bits and settings
^=	Mutually exclusive or set
=	Bit or setting

Operator column table

Operation symbol	Explanation
+	addition
-	Subtraction
*	Multiplication
/	Division
%	Integer remainder

!	Logical inverse
~	Bitwise inverse
==	equal
!=	not equal to
<	Less than
<=	Less than or equal to
>	More than
>=	More than or equal to
or "OR"	Logical or Operations
&& or "AND"	Logical and Operations
&	Bits and operations
^	Bit-exclusive OR operation
	Bits or operations
<<	Left shift
>>	Right shift

## Command list

instruction	Explanation
LABEL (constant)	Program position label (constant range is 0-65535)
GOT (constant)	Jump to the program position label unconditionally (constant range is 0-65535)
CALL <Expression>	Call sub macro (sub macro number 1-512)
RET	Return to calling program location
IF <Expression> THEN GOTO LABEL <constant>	When the variable condition is established (not equal to 0), jump to the program position label, otherwise continue to the next line of instructions.
IF <Expression> THEN DO	When the variable condition is established (not equal to 0), continue to the next line of instructions, otherwise jump to the next judgment (ELIF) or (ELSE DO) to continue to execute or execute the next line of instructions of ENDIF.

ELIF <Expression> THEN DO	When the variable condition is established (not equal to 0), continue to the next line of instructions, otherwise jump to the next judgment (ELIF) or (ELSE DO) to continue to execute or execute the next line of instructions of ENDIF.
ELSE DO	In conjunction with the IF or ELIF instruction, it indicates the position to be executed when the variable condition is not established (equal to 0).
ENDIF	With the IF or ELIF instruction, it indicates the position to jump when the variable condition is not established (equal to 0).
FOR <Expression>	Program loop, using the value of the expression as a fixed number of cycles, the program range is the program from FOR to the corresponding NEXT.
NEXT	In conjunction with the FOR instruction, it indicates the range of the program loop.
END	End macro program
SETB (Bit variable address)	Set bit variables
CLRB (Bit variable address)	Clear bit variables
INVB (Bit variable address)	Antiphase variable

### System internal address variables N0-N65535

N0-N65535 are address variables planned by HMI internally, with a total of 65536 WORDs (16Bits).

When the data format is set to DWORD, the system will automatically read a WORD after the number, which is defined as the high bit, Hi WORD, and together with the selected variable low bit, Lo WORD, to form a DWORD. For example, DWORD N0, then N0 is Lo WROD and N1 is Hi WROD, forming DWORD.

When the data format is WORD, you can directly use the defined variable name, namely N0-N65535.

When you want to use bit to define the address, you need to add a "." Symbol after the definition name before bit position 0 ~ 15. For example, the fifth bit of N0 can be written as "N0.5", and the eleventh bit of N100 can be written as "N100.11".

### 11.3.2 Instructions

#### 1. LABEL <constant>

Program position label (constant range is 0-65535)

The position of the label can be any line in the program.

Examples of label macros:

```
N0 = 100
#Define label number 10
LABEL 10
N1 = 200
...
GOTO LABEL 10
...
GOTO LABEL 20
...
#Define tag number 20
LABEL 20
```

## 2. GOTO <constant>

Unconditionally jump to the program location label (constant range is 0-65536)

```
N0 = 100
LABEL 10
N1 = 200
...
...
# Jump to the position of label number 10
GOTO LABEL 10
```

## 3. CALL <variable / constant / expression>

Call sub macro (sub macro number 1-512)

The parameters of the call sub-macro instruction can be variables or constants or expressions

```
N0 = 100
#CALL <variable>
CALL N0
...
#CALL <constant>
CALL N100
...
#CALL <expression>
CALL 100 + N0
```

## 4. RET

Return to the initial position of the call macro

## 5. IF <variable> THEN GOTO LABEL <constant>

When the variable condition is established (not equal to 0), jump to the program position label, otherwise continue to the next line of instructions

```
LABEL 10
```

...  
 #When the variable (N0 + N1) is equal to 200, jump to the position of label 10

```
IF (N0 + N1) == 200 THEN GOTO LABEL 10
```

#### 6. IF <variable> THEN DO

When the variable condition is established (not equal to 0), continue to the next line of instructions, otherwise jump to the next judgment (ELIF) or (ELSE DO) to continue to execute or execute the next line of instructions of ENDIF. IF, ENDIF support structure up to 16 layers.

#When the variable N0 is not equal to 100, execute the instruction of N1 = 1000 on the next line

```
IF N0! = 100 THEN DO
```

```
N1 = 1000
```

#IF ... THEN DO must be paired with ENDIF

```
ENDIF
```

#### 7. ENDIF <variable> THEN DO

When the variable condition is established (not equal to 0), continue to the next line of instructions, otherwise jump to the next judgment (ELIF) or (ELSE DO) to continue to execute or execute the next line of instructions in ENDIF.

#When the variable N0 is equal to 100, execute the instruction of N1 = 1000

#When the variable N0 is equal to 200, execute the instruction of N1 = 2000

```
IF N0! = 100 THEN DO
```

```
N1 = 1000
```

#ELIF must follow the IF THEN DO syntax

```
ELIF N0 == 200 THEN DO
```

```
N1 = 2000
```

```
ENDIF
```

#### 8. ENDIF

With the IF or ELIF instruction, it indicates the position to jump when the variable condition is not established (equal to 0). IF, ENDIF support structure up to 16 layers.

#When the variable N0 is equal to 100, execute the instruction of N1 = 1000

```
IF N0! = 100 THEN DO
```

```
N1 = 1000
```

#IF ... THEN DO must be paired with ENDIF

```
ENDIF
```

#### 9. FOR <variable>

Program loop, the loop takes the value of the variable as a fixed number, and the program range is from FOR to the program corresponding to NEXT. FOR, NEXT support structure up to 16 layers.



```

    #Calculate the total number of 1 to 10 in the N0 variable
N0 = 0
N1 = 1
FOR 10
N0 + = N1
N1 + = 1
NEXT
10. NEXT

```

With the FOR instruction, it indicates the range of the program loop. FOR, NEXT support structure up to 16 layers.

```

#Calculate the total number of 1 to 10 in the N0 variable
N0 = 0
N1 = 1
FOR 50
N0 + = N1
N1 + = 1
NEXT
11.END

```

End macro program

12. SETB <Bit Variable Position>

Set bit variables

#Set the fifth bit of N100 variable to 1

SETB N100.5

13. CLR B <Bit Variable Position>

Clear bit variables

#Set the 12th bit of the N10 variable to 0

CLRB N10.12

14. INVB <Bit Variable Position>

Antiphase variable

#Reverse the 15th position of the N1 variable (0 becomes 1, 1 becomes 0)

INVB N1.15

## 11.4 Introduction to Macro Operator Syntax

In View Macro, in addition to instruction usage, there are two important syntaxes: operator syntax and set operator syntax.

### 11.4.1 Operator syntax

Provide mathematical operations or logical operations between variables. These operation symbols are called operands. The currently available operators are listed in the table Macro Operators, there are 20 operations in total. The expression is mainly used to set the expression syntax and the in-command syntax.

Use Cases:

Pure expression

$(N0 + N1) / 2$

$(N0 + 100)$

Collocation operator

$N0 = (N1 \ll 2)$

$N0 += (N1 + 2) / 2$

Collocation instruction

IF (N0 == 100) && (N1 == 200) THEN GOTO LABEL 10

ENDIF

CALL (N0+100)

#### 11.4.2 Set operator syntax

The setting operator syntax is the most important syntax for setting the value of variables in macro commands. This setting symbol is called the setting operator. There are currently 11 kinds of setting operators.

Use Cases:

$N0 = 100$

$N0 = (N1 + N2) / 2$

$N0 += 100$

$N0 * = 2$

$N0 \ll = 2$

#### 11.4.3 Data format setting of variable data

Variable information: The only variables that can be used in the macros currently provided are system variables. The default data format of the system variable is 16-bit symbol number. If you need other format operations, you must add the data format setting. The data format setting is to add parentheses before the variable and fill in the data format definition in the bracket .

Case:

#Indicates the use of 32-bit signed number operation, the data position is in N0  
(INT32S) N0

#### 11.4.4 Setting the data format setting for calculation

Setting operation: When the set variable needs to set the data format, the end of the variable command line must be set with parentheses, and the data format definition is filled in the parentheses. For example,  $N0 = (\text{INT32S}) N100$  (INT32S) means that the 32-bit signed number N100 is used for calculation, and the value of the N100 is set to the 32-bit signed number N0.

Case:

#Bit address and settings

$N0.3 = (\text{BIT}) N10.4 \ \&\& \ (\text{BIT}) N10.5 \ (\text{BIT})$

#If the variable data format of the same line is the same, you can only set the

data format of [Set Calculation]

N0.3 = N10.4 && N10.5 (BIT)

# 32 bit signed number operation

N0 = N2 + N4 (INT32S)

N0 = N2 + N4 (SIGNED DW)

# 32-bit floating point arithmetic

N0 = N2 + N4 (FLOAT)

## Chapter 12 Macro Function

### 12.1 Introduction to calculation functions and syntax

#### 12.1.1 Function column table

Fun. Name	Fun. function	Return value	Parameter 1	Parameter 2
_PI	Returns $\pi$ floating point value	FLOAT3 2		
_BCD	Convert BIN values to BCD format	INT32U	INT32U	
_BIN	Convert BCD value to BIN format value	INT32U	INT32U	
_SQRT	Square root floating point value	FLOAT3 2	FLOAT3 2	
_LOG	Natural logarithmic floating point value	FLOAT3 2	FLOAT3 2	
_LOG10	Base 10 log floating point value	FLOAT3 2	FLOAT3 2	
_RADIAN	Convert degrees to radian floating point values	FLOAT3 2	FLOAT3 2	
_DEGREE	Convert radians to degrees floating point	FLOAT3 2	FLOAT3 2	
_SIN	trigonometric function sine value floating point value	FLOAT3 2	FLOAT3 2	
_COS	Trigonometric function cosine value floating point value	FLOAT3 2	FLOAT3 2	
_TAN	Trigonometric function tangent floating point value	FLOAT3 2	FLOAT3 2	
_ASIN	Trigonometric function arc sine value floating point value	FLOAT3 2	FLOAT3 2	
_ACOS	Trigonometric function inverse cosine floating point value	FLOAT3 2	FLOAT3 2	
_ATAN	Trigonometric function arc tangent floating point value	FLOAT3 2	FLOAT3 2	
_ABS	Absolute floating point value	FLOAT3 2	FLOAT3 2	

### 12.1.2 Introduction to Function Syntax

#### 1. Floating-point constant

Directly set floating point constants to variables

N0 = 1.2345 (FLOAT32)

#### 2. \_BCD

Convert BIN values to BCD format

Function syntax: INT32U \_BCD (INT32U)

Input data format: INT32U 32-bit unsigned value

Return data format: INT32U 32-bit unsigned value

Example: N2 = \_BCD (N0) (INT32U)

#### 3. \_BIN

Convert BCD value to BIN format value

Function syntax: INT32U \_BIN (INT32U)

Input data format: INT32U 32-bit unsigned value

Return data format: INT32U 32-bit unsigned value

Example: N4 = \_BIN (N2) (INT32U)

#### 4. \_SQRT

Calculate the square root floating point value

Function syntax: FLOAT32 \_SQRT (FLOAT32)

Input data format: FLOAT32 floating point value

Return data format: FLOAT32 square root floating point value

Example: N0 = \_SQRT (1.15129) (FLOAT32) #  $1.5129 = 1.23 * 1.23$

#### 5. \_LOG

Calculate natural logarithmic floating point values

Function syntax: FLOAT32 \_LOG (FLOAT32)

Input data format: FLOAT32 floating point value

Return data format: FLOAT32 natural logarithmic floating point value

Example: N0 = \_LOG (N2) (FLOAT32)

#### 6. \_LOG10

Calculate a logarithmic floating point value with base 10

Function syntax: FLOAT32 \_LOG10 (FLOAT32)

Input data format: FLOAT32 floating point value

Return data format: FLOAT32 base 10 logarithmic floating point value

Example: N0 = \_LOG10 (N2) (FLOAT32)

#### 7. \_RADIAN

Convert degrees to radian floating point values

Function syntax: FLOAT32 \_RADIAN (FLOAT32)

Input data format: FLOAT32 degree floating point value

Return data format: FLOAT32 radian floating point value

Example: N0 = \_RADIAN (N2) (FLOAT32)

#### 8. \_DEGREE

Convert radians to degrees floating point

Function syntax: FLOAT32 \_DEGREE (FLOAT32)

Input data format: FLOAT32 radian floating point value



Return data format: FLOAT32 degree floating point value

Example: N0 = \_DEGREE (N2) (FLOAT32)

9, \_SIN

Calculate trigonometric function sine value floating point value

Function syntax: FLOAT32 \_SIN (FLOAT32)

Input data format: FLOAT32 radian floating point value

Return data format: FLOAT32 sine floating point value

Example: N0 = \_SIN (N2) (FLOAT32)

10, \_COS

Calculate trigonometric function cosine floating point value

Function syntax: FLOAT32 \_COS (FLOAT32)

Input data format: FLOAT32 radian floating point value

Return data format: FLOAT32 Cosine floating point value

Example: N0 = \_COS (N2) (FLOAT32)

11, \_TAN

Calculate trigonometric function tangent floating point value

Function syntax: FLOAT32 \_TAN (FLOAT32)

Input data format: FLOAT32 radian floating point value

Return data format: FLOAT32 tangent floating point value

Example: N0 = \_TAN (N2) (FLOAT32)

12, \_ASIN

Calculates the trigonometric function arc sine value floating point value

Function syntax: FLOAT32 \_ASIN (FLOAT32)

Input data format: FLOAT32 radian floating point value

Return data format: FLOAT32 arc sine floating point value

Example: N0 = \_ASIN (N2) (FLOAT32)

13, \_ACOS

Calculate trigonometric function inverse cosine value floating point value

Function syntax: FLOAT32 \_ACOS (FLOAT32)

Input data format: FLOAT32 radian floating point value

Return data format: FLOAT32 arc cosine floating point value

Example: N0 = \_ACOS (N2) (FLOAT32)

14, \_ATAN

Calculate trigonometric function arc tangent floating point value

Function syntax: FLOAT32 \_SIN (FLOAT32)

Input data format: FLOAT32 radian floating point value

Return data format: FLOAT32 arc tangent floating point value

Example: N0 = \_ATAN (N2) (FLOAT32)

15, \_ABS

Calculate absolute value floating point value

Function syntax: FLOAT32 \_ABS (FLOAT32)

Input data format: FLOAT32 input calculation floating point value

Return data format: FLOAT32 absolute value floating point value

Example: N0 = \_ABS (-1.23) (FLOAT32)

16, \_PI

Returns  $\pi$  floating point value

Function syntax: FLOAT32 \_PI ()

Input data format: none

Return data format: FLOAT32 returns  $\pi$  floating point value

Example: N0 = \_PI () (FLOAT32)

Macro option register

N65152.0 (bit 0)

0 = When the controller variable is set, modify the value through communication.

1 = When the controller variable is set, directly modify the HMI memory data and modify the value through communication.

## 12.2 Introduction to register related functions and syntax

### 12.2.1 List of register functions

Fun. Name	Function
_MEMCPY	Memory copy
_MEMCMP	Memory comparison
_MEMSET	Memory settings
_REGCPY	Variable area copy
_REGCMP	Variable area comparison
_REGSET	Variable locale
_MWORD2 BYTE	Convert multiple word data to multiple bytes
_MBYTE2W ORD	Convert multiple bytes of data to multiple words
_RBREAD	Read the data in the bank memory area after power off
_RBWRITE	Write data to keep Bank memory area after power off

### 12.2.2 Introduction to Function Syntax

1.\_MEMCPY

Memory copy: copy data from variable memory area to another variable memory area

INT32S \_MEMCPY (INT32S destRegNum, INT32S srcRegNum, INT32S len)

The use range of destRegNum is 0 ~ 64511

The use range of srcRegNum is 0 ~ 64511

len use range is 1 ~ 256

The returned value indicates the number of bits copied. 0 means the memory

range is wrong; 1 ~ 256 means the number of copied bits.

Example 1:

N100 = \_MEMCPY (200, 250, 10)

It means that 10 BYTES starting from the N250 variable (that is, 5 variables N250-N254) are copied into N200-N204, and the number of copy bits (BYTE) 10 is placed in N100.

Example 2:

N100 = 1000

N101 = 1500

N102 = 20

N500 = \_MEMCPY (N100, N101, N102)

It means that the 20 BYTES starting from the N1500 variable (that is, the 10 variables N1500-N1509) are copied into the N1000-N1009, and the number of copied bits (BYTE) 20 is placed in the N500.

related functions

\_MEMCMP, \_MEMSET, \_REGCPY, \_REGCMP, \_REGSET

## 2. \_MEMCMP

Memory comparison: compare the same number of bits (BYTE) in the memory area of 2 variables

INT32S \_MEMCMP (INT32S destRegNum, INT32S srcRegNum, INT32S len)

The use range of destRegNum is 0 ~ 65535

The use range of srcRegNum is 0 ~ 65535

len use range is 1 ~ 256

The returned value indicates the comparison result. -1 means that the memory range is wrong; 0 means the variable content is the same; 1 means the variable content is different.

example:

N100 = \_MEMCMP (1000, 2000, 10)

Compare whether the variable values of N1000-N1004 and N2000-N2004 are the same.

related functions

\_MEMCPY, \_MEMSET, \_REGCPY, \_REGCMP, \_REGSET

## 3. \_MEMSET

Memory setting: set all elements in a variable memory area to a specific value

INT32S \_MEMSET (INT32U regNum, INT32S value, INT32S len)

regNum use range is 0 ~ 64511

len use range is 1 ~ 256

The returned value indicates the set number of bits. 0 means the memory range is wrong; 1 ~ 256 means the set number of bits.

example:

N100 = \_MEMSET (1000, 55H, 10)

Set the value of N1000-N1004 to 5555H. (The default setting is 8 bits),

and the N variable is 16 bits.)

related functions

`_MEMCPY, _MEMCMP, _REGCPY, _REGCMP, _REGSET`

#### 4. `_REGCPY`

Variable area copy: copy data from the variable memory area to another variable memory area

`INT32S _REGCPY(INT32S destRegNum, INT32S srcRegNum, INT32S len)`

The use range of `destRegNum` is 0 ~ 64511

The use range of `srcRegNum` is 0 ~ 64511

`len` use range is 1 ~ 256

The returned value indicates the number of variables copied. 0 means that the memory range is wrong; 1 ~ 256 means the number of copied variables.

Example 1:

`N100 = _REGCPY (200, 250, 10)`

Copy the value of the N250-259 variable into the N200-N209 variable.

Example 2:

`N100 = 1000`

`N101 = 1500`

`N102 = 20`

`N500 = _REGCPY (N100, N101, N102)`

Copy the N1500-N1519 variables to the N1000-N1019 variables.

Related functions

`_MEMCPY, _MEMCMP, _MEMSET, _REGCMP, _REGSET`

#### 5. `_REGCMP`

Variable area comparison: compares a certain number of variables (16Bits) in two variable memory areas

`INT32S _REGCMP (INT32S destRegNum, INT32S srcRegNum, INT32S len)`

The use range of `destRegNum` is 0 ~ 65535

The use range of `srcRegNum` is 0 ~ 65535

`len` use range is 1 ~ 256

The returned value indicates the comparison result. -1 means that the memory range is wrong; 0 means the variable content is the same; 1 means the variable content is different.

example:

`N100 = _REGCMP (1000, 2000, 10)`

Compare whether the variable values of N1000-N1009 and N2000-N2009 are the same.

related functions

`_MEMCPY, _MEMCMP, _MEMSET, _REGCPY, _REGSET`

## 6. \_REGSET

Variable area setting: Set all variables in a variable memory area to a certain value

INT32S \_REGSET (INT32U regNum, INT32S value, INT32S len)

regNum use range is 0 ~ 64511

len use range is 1 ~ 256

The returned value indicates the set number of bits. 0 means the memory range is wrong; 1 ~ 256 means the set number of bits.

example:

N100 = \_REGSET (1000, 1234, 10)

Set the value of N1000-N1009 to 1234.

related functions

\_MEMCPY, \_MEMCMP, \_MEMSET, \_REGCPY, \_REGCMP

## 7. \_MWORD2BYTE

Convert multiple word data to multiple bytes: The return value indicates the number of conversions

INT32U \_MWORD2BYTE (INT32S destByteRegNum, INT32S srcWordRegNum, INT32S len)

The use range of destByteRegNum is 0 ~ 64511

The use range of srcWordRegNum is 0 ~ 64511

len use range is 1 ~ 256

The returned value indicates the number of conversions. 0 means the memory range is wrong; 1 ~ 256 means the number of conversions.

example:

\_STRW (N200, "ABCD")

\_MWORD2BYTE (100, 200, 4)

Results of the

N100 = 4241H

N101 = 4443H

N200 = 0041H

N201 = 0042H

N202 = 0043H

N203 = 0044H

related functions

\_MBYTE2WORD

## 8. \_MBYTE2WORD

Conversion of multiple bytes of data to multiple words: the return value indicates the number of conversions

INT32U \_MBYTE2WORD (INT32S destWordRegNum, INT32S srcByteRegNum, INT32S len)

destWordRegNum is used in the range of 0 ~ 64511



The use range of srcByteRegNum is 0 ~ 64511

len use range is 1 ~ 256

The returned value indicates the number of conversions. 0 means the memory range is wrong; 1 ~ 256 means the number of conversions.

example:

```
_STRW (N200, "ABCD")
_MBYTE2WORD (100, 200, 4)
```

Results of the

N100 = 0041H

N101 = 0042H

N102 = 0043H

N103 = 0044H

N200 = 4241H

N201 = 4443H

related functions

```
_MWORD2BYTE
```

## 9, \_RBREAD

Read the data in the bank memory area after power off: the return value indicates the number of registers read

```
INT32S _RBREAD (INT32S bank, INT32S destRegNum, INT32S scrAddr,
INT32S cnt)
```

Bank usage range is 0 ~ 6 (currently only open 0: Bank0)

destRegNum the number of the destination register location for reading data

scrAddr read the number of the bank's source location

cnt can be used in the range 1 ~ 8192

When the returned value is 0: it means that the variable range is wrong or the operating model does not provide the power-off retentive bank memory; other values read represent the number of registers read.

Note: This macro function is only supported for models that provide bank memory to keep power off.

example:

```
N100 = _RBREAD (0, 1000, 3000, 100)
```

Results of the

N100 = 100

N1000 ~ N1099 = RBank.3000 ~ RBank.3099

related functions

```
_RBWRITE
```

## 10. \_RBWRITE

Write the data in the bank memory area when power off: the return value indicates the number of registers written

```
INT32S _RBWRITE (INT32S bank, INT32S scrRegNum, INT32S destAddr,
INT32S cnt)
```

Bank usage range is 0 ~ 6 (currently only open 0: Bank0)

ScrRegNum data source register location number

destAddr writes the number of the destination location in the Bank

cnt can be used in the range 1 ~ 8192

When the returned value is 0: it means that the variable range is wrong or the running model does not provide the power-off retentive bank memory; other values read represent the number of registers written.

Note: This macro function is only supported for models that provide bank memory to keep power off.

Example:

```
N100 = _RBWRITE (0, 1000, 3000, 100)
```

Results of the

```
N100 = 100
```

```
RBank.3000 ~ RBank.3099 = N1000 ~ N1099
```

related functions

```
_RBREAD
```

## 12.3 Introduction to string related functions and syntax

### 12.3.1 List of string functions

Name	Function
_STR	Set ASCII (bit) string to variable memory
_STRW	Set Unicode (word) character string to variable memory
_STRLEN	Returns the ASCII (bit) string length
_STRWLEN	Returns the length of the Unicode (word) string
_STR2DEC	Convert decimal string to numeric value
_STR2HEX	Convert hexadecimal string to numeric value
_STR2BIN	Convert binary string to numeric value
_DECSTR	Convert numeric value to decimal string
_HEXSTR	Convert numeric value to hexadecimal string
_BINSTR	Convert numeric value to binary string

### 12.3.2 Introduction to String Function Syntax

## 1.\_STR

Set ASCII (bit) character string to variable memory: Write ASCII (8 Bits) character string to variable memory area

INT32S \_STR (REG reg, STRING str)

Reg can be used from N0 to N64511

Str is an ASCII string, the string length is 1 ~ 256

The return value indicates the length of the bit, 0 indicates that the memory range is wrong; 1 ~ 256 indicates the length of the set bit.

In addition to the general text in the string format, you can also use the "\" escape symbol to add non-string text

Escape symbol	Character value
""	22H=34
\'	27H=39
\"	22H=34
\?	3FH=63
\\	5CH=92
\r	0DH=13
\n	0AH=10
\000~\777	Octal code character
\x00~\xFF	Hexadecimal code character

example:

```
N100 = _STR (N1000, "ABCD")
```

Results of the

```
N100 = 5
```

```
N1000 = 4241H // 'BA'
```

```
N1001 = 4443H // 'CD'
```

```
N1002 = 0000H // End of string
```

related functions

\_STRW

## 2.\_STRW

Set Unicode (word) character string to variable memory: write Unicode (16Bits) character string to variable memory area

INT32S \_STRW (INT32U regNum, STRING str)

regNum can be used in the range of 0 ~ 64511

Str is a Unicode string, the string length is 1 ~ 256

The return value indicates the length of the bit, 0 indicates that the memory range is wrong; 1 ~ 256 indicates the length of the set bit.

note:

When the string uses Unicode encoding, when the HMI displays the string, the internal encoding is only the lower 7 bits (0-127 English font) the same as Unicode, so when the Unicode encoding exceeds 127 in the string,

the HMI will display incorrect or unable display.

example:

```
N100 = _STRW (N1000, "ABCD")
```

Results of the

N100 = 10

N1000 = 0041H // 'A'

N1001 = 0042H // 'B'

N1002 = 0043H // 'C'

N1003 = 0044H // 'D'

N1004 = 0000H // End of string

related functions

\_STR, \_STRLEN, \_STRWLEN

### 3. \_STRLEN

Returns the length of the ASCII (bit) string: the return value represents the length of the ASCII string

INT32U \_STRLEN (INT32S regNum)

regNum can be used in the range 0 ~ 64383

The return value indicates the length of the character string. 0 indicates that the variable range is incorrect or the length exceeds 256 or the length of the character string is 0;

example:

```
_STR (N200, "ABCD")
```

```
N100 = _STRLEN (200)
```

Results of the

N100 = 4

N200 = 4241H

N201 = 4443H

related functions

\_STR, \_STRW, \_STRWLEN

### 4. \_STRWLEN

Returns the length of the Unicode (word) string: the return value represents the length of the Unicode string

INT32U \_STRWLEN (INT32S regNum)

regNum can use the range 0 ~ 64255

The return value indicates the length of the string, 0 indicates that the variable range is wrong or the length exceeds 256 or the string length is 0; 1 ~ 256 indicates the length of the string.

example:

```
_STRW (N200, "ABCD")
```

```
N100 = _STRWLEN (200)
```

Results of the

N100 = 4

N200 = 0041H

N201 = 0042H  
 N202 = 0043H  
 N203 = 0044H  
 related functions  
 \_STR, \_STRW, \_STRLEN

### 5. \_STR2DEC

Convert a decimal string to a numeric value: The return value represents the converted numeric value

INT32S \_STR2DEC (INT32S regNum, INT32S cnt)

regNum can be used in the range 0 ~ 65535

cnt can use the range 1 ~ 256 (when the value range is exceeded, an overflow error will occur, resulting in an incorrect value)

A return value of 0 indicates that the variable range is incorrect or the value is 0; other values indicate the converted value.

Example 1:

```
_STRW (N100, "12345")
N200 = _STRWLEN (100)
      N500 = _STR2DEC (100, N200)
```

Results of the

N100 = 0031H  
 N101 = 0032H  
 N102 = 0033H  
 N103 = 0034H  
 N104 = 0035H  
 N200 = 5  
 N500 = 12345

Example 2:

```
_STRW (N100, "1234567")
N200 = _STRWLEN (100)
      N500 = _STR2DEC (100, N200) (DW)
```

Results of the

N100 = 0031H  
 N101 = 0032H  
 N102 = 0033H  
 N103 = 0034H  
 N104 = 0035H  
 N105 = 0036H  
 N106 = 0037H  
 N200 = 7  
 N500 = -10617  
 N501 = 18

Double word N500 = 1234567

related functions



\_STR2HEX, \_STR2BIN

## 6. \_STR2HEX

Convert hexadecimal string to numeric value: The return value represents the converted numeric value

INT32S \_STR2HEX (INT32S regNum, INT32S cnt)

regNum can be used in the range 0 ~ 65535

Cnt can use the range 1 ~ 256 (when the conversion exceeds the value range, an overflow error will occur, resulting in an incorrect value)

A return value of 0 indicates that the variable range is incorrect or the value is 0; other values indicate the converted value.

Example 1:

\_STRW (N100, "55AA")

N200 = \_STRWLEN (100)

N500 = \_STR2HEX (100, N200)

Results of the

N100 = 0035H

N101 = 0035H

N102 = 0041H

N103 = 0041H

N200 = 4

N500 = 55AAH

Example 2:

\_STRW (N100, "1234567")

N200 = \_STRWLEN (100)

N500 = \_STR2HEX (100, 2)

Results of the

N100 = 0031H

N101 = 0032H

N102 = 0033H

N103 = 0034H

N104 = 0035H

N105 = 0036H

N106 = 0037H

N200 = 7

N500 = 0012H

related functions

\_STR2DEC, \_STR2BIN

## 7. \_STR2BIN

Convert a binary string to a numeric value: The return value represents the converted numeric value

INT32S \_STR2BIN (INT32S regNum, INT32S cnt)

regNum can be used in the range 0 ~ 65535

Cnt can use the range 1 ~ 256 (when the conversion exceeds the value range, an overflow error will occur, resulting in an incorrect value)

Binary strings can use 'H' or '1' to represent the value of 1

Binary strings can use 'L' or '0' to represent the value of 0

Binary strings can use ':' or '\_' to delimit

A return value of 0 indicates that the variable range is incorrect or the value is 0; other values indicate the converted value.

Example 1:

```
_STRW (N100, "10100000_00000001")
```

```
N200 = _STRWLEN (100)
```

```
N500 = _STR2BIN (100, N200)
```

Results of the

```
N100 ~ N116 = "10100000_00000001"
```

```
N200 = 17
```

```
N500 = A001H
```

Example 2:

```
_STRW (N100, "HLHL: LHLH: HHHH: LLLL")
```

```
N200 = _STRWLEN (100)
```

```
N500 = _STR2BIN (100, N200)
```

Results of the

```
N100 ~ N118 = "HLHL: LHLH: HHHH: LLLL"
```

```
N200 = 19
```

```
N500 = A5F0H
```

related functions

```
_STR2DEC, _STR2HEX
```

## 8. \_DECSTR

Convert the numeric value to a decimal string: The return value indicates the length of the converted string

```
INT32S _DECSTR (INT32S destRegNum, INT32S data, INT32S format)
```

destregNum can use the range 0 ~ 64255

data The converted value entered

Format converts the value format

0: 8-bit signed number

1: 8-bit unsigned number

2: 16-bit signed number

3: 16-bit unsigned number

4: 32-bit signed number

5: 32-bit unsigned number

A return value of 0 indicates that the variable range is incorrect or the value is 0; other values indicate the converted string length.

Example 1:

```
N200 = _DECSTR (100, 12345, 2)
```

Results of the

N100 ~ N104 = "12345"

N200 = 5

Example 2:

N200 = \_DECSTR (100, -12345, 2)

Results of the

N100 ~ N104 = "-12345"

N200 = 6

related functions

\_HEXSTR, \_BINSTR

## 9. \_HEXSTR

Convert the numeric value to a hexadecimal string: The return value indicates the length of the converted string

INT32S \_HEXSTR (INT32S destRegNum, INT32S data, INT32S format)

destregNum can use the range 0 ~ 64255

data The converted value entered

Format converts the value format

0: 8-bit unsigned number, convert string lowercase 0-9, a-f

1: 8-bit unsigned number, converted string uppercase 0-9, A-F

2: 16-bit unsigned number, conversion string lowercase 0-9, a-f

3: 16-bit unsigned number, converted string uppercase 0-9, A-F

4: 32-bit unsigned number, conversion string lowercase 0-9, a-f

5: 32-bit unsigned number, converted string uppercase 0-9, A-F

A return value of 0 indicates that the variable range is incorrect or the value is 0; other values indicate the converted string length.

Example 1:

N200 = \_HEXSTR (100, 0AA55H, 2)

Results of the

N100 ~ N103 = "aa55"

N200 = 4

Example 2:

N200 = \_HEXSTR (100, 55AAFF00H, 5)

Results of the

N100 ~ N107 = "55AAFF00"

N200 = 8

related functions

\_DECSTR, \_BINSTR

## 10. \_BINSTR

Convert the numeric value to a binary string: the return value indicates the length of the converted string

INT32S \_BINSTR (INT32S destRegNum, INT32S data, INT32S format)

destregNum can use the range 0 ~ 64255

data The converted value entered

Format converts the value format

0: 8-bit unsigned number, convert string 0, 1

1: 8-bit unsigned number, convert character string H, L

2: 16-bit unsigned number, conversion string 0, 1

3: 16-bit unsigned number, convert string H, L

4: 32-bit unsigned number, conversion string 0, 1

5: 32-bit unsigned number, convert character string H, L

A return value of 0 indicates that the variable range is incorrect or the value is 0; other values indicate the converted string length.

Example 1:

N200 = \_BINSTR (100, 0AA55H, 2)

Results of the

N100 ~ N115 = "1010101001010101"

N200 = 16

Example 2:

N200 = \_BINSTR (100, 55A AFF00H, 5)

Results of the

N100 ~ N131 = "LHLHLHLHHLHLHLHLHHHHHHHHLLLLLLLLL"

N200 = 32

related functions

\_DECSTR, \_HEXSTR

## 12.4 Introduction to Mathematical Calculation Related

### Functions and Grammar

#### 12.4.1 A column table of mathematical calculation related functions

Name	Function
_MIN	Take the minimum of multiple 16-bit signed numbers
_MAX	Take the maximum of multiple 16-bit signed numbers
_AVE	Take the average of multiple 16-bit signed numbers
_MIND	Take the minimum of multiple 32-bit signed numbers
_MAXD	Take the maximum of multiple 32-bit signed numbers
_AVED	Take the average of multiple 32-bit signed numbers
_MINF	Take the minimum of multiple 32-bit symbol points

_MAXF	Take the maximum of multiple 32-bit symbol points
_AVEF	Take the average of multiple 32-bit symbol points

## 12.4.2 Introduction to Mathematical Calculation Related Function Syntax

### 1. \_MIN

Take the minimum value of multiple 16-bit signed numbers: the return value indicates the minimum value of the multiple data

INT32S \_MIN (INT32S regNum, INT32S cnt)

regNum can be used in the range 0 ~ 65535

Cnt can use the range 1 ~ 256

The return value of 0 means that the variable range is wrong or the minimum value is 0; other values are the minimum value returned.

example:

N100 = 156

N101 = 6578

N102 = -578

N103 = 4568

N200 = \_MIN (100, 4)

Results of the

N200 = -578

related functions

\_MAX, \_AVE

### 2. \_MAX

Take the maximum value of multiple 16-bit signed numbers: the return value indicates the maximum value of the multiple data

INT32S \_MAX (INT32S regNum, INT32S cnt)

regNum can be used in the range 0 ~ 65535

Cnt can use the range 1 ~ 256

A return value of 0 means that the variable range is wrong or the maximum value is 0; other values are the maximum value returned.

example:

N100 = 156

N101 = 6578

N102 = -578

N103 = 4568

N200 = \_MAX (100, 4)

Results of the

N200 = 6578

related functions

\_MIN, \_AVE



### 3. \_AVE

Take the average of multiple 16-bit signed numbers: the return value represents the average of the multiple data  
INT32S \_AVE (INT32S regNum, INT32S cnt)  
regNum can be used in the range 0 ~ 65535  
Cnt can use the range 1 ~ 256

A return value of 0 means that the variable range is wrong or the maximum value is 0; other values are the maximum value returned.

example:

N100 = 156

N101 = 6578

N102 = -578

N103 = 4568

N200 = \_AVE (100, 4)

Results of the

N200 = 2681

related functions

\_MIN, \_MAX

### 4. \_MIND

Take the minimum value of multiple 32-bit signed numbers: the return value represents the minimum value of the multiple data  
INT32S \_MIND (INT32S regNum, INT32S cnt)  
regNum can be used in the range 0 ~ 65534  
Cnt can use the range 1 ~ 128

The return value of 0 means that the variable range is wrong or the minimum value is 0; other values are the minimum value returned.

example:

N100 = 1564 (DW)

N102 = 6573458 (DW)

N104 = -574358 (DW)

N106 = 4568 (DW)

N200 = \_MIND (100, 4) (DW)

Results of the

N200 = -574358

related functions

\_MAXD, \_AVED

### 5. \_MAXD

Take the maximum value of multiple 32-bit signed numbers: the return value indicates the maximum value of the multiple data  
INT32S \_MAXD (INT32S regNum, INT32S cnt)  
regNum can be used in the range 0 ~ 65534  
Cnt can use the range 1 ~ 128

A return value of 0 means that the variable range is wrong or the maximum value is 0; other values are the maximum value returned.

example:

N100 = 1564 (DW)

N102 = 6573458 (DW)

N104 = -574358 (DW)

N106 = 4568 (DW)

N200 = \_MAXD (100, 4) (DW)

Results of the

Double word N200 = 6573458

related functions

\_MIND, \_AVED

## 6. \_AVED

Take the average of multiple 32-bit signed numbers: the return value represents the average of the multiple data

INT32S \_AVED (INT32S regNum, INT32S cnt)

regNum can be used in the range 0 ~ 65534

Cnt can use the range 1 ~ 128

The 32-bit signed number is used to calculate the average value. Please pay attention to whether the total value overflows.

A return value of 0.0 means that the variable range is wrong or the maximum value is 0.0; other values are the maximum value returned.

example:

N100 = 1564 (DW)

N102 = 6573458 (DW)

N104 = -574358 (DW)

N106 = 4568 (DW)

N200 = \_AVED (100, 4) (DW)

Results of the

Double word N200 = 151308

related functions

\_MIND, \_MAXD

## 7. \_MINF

Take the minimum value of multiple 32-bit symbol points: the return value represents the minimum value of the multiple data

INT32S \_MINF (INT32S regNum, INT32S cnt)

regNum can be used in the range 0 ~ 65534

Cnt can use the range 1 ~ 128

The return value of 0 means that the variable range is wrong or the minimum value is 0; other values are the minimum value returned.

example:

N100 = 15.64 (FLOAT)  
 N102 = 6573.458 (FLOAT)  
 N104 = -5743.58 (FLOAT)  
 N106 = 45.68 (FLOAT)  
 N200 = \_MINF (100, 4) (FLOAT)

Results of the  
 Floating point N200 = -5743.58  
 related functions  
 \_MAXF, \_AVEF

#### 8. \_MAXF

Take the maximum value of multiple 32-bit symbol points: the return value indicates the maximum value of the multiple data  
 INT32S \_MAXF (INT32S regNum, INT32S cnt)  
 regNum can be used in the range 0 ~ 65534  
 Cnt can use the range 1 ~ 128

A return value of 0.0 means that the variable range is wrong or the maximum value is 0.0; other values are the maximum value returned.  
 example:

N100 = 15.64 (FLOAT)  
 N102 = 6573.458 (FLOAT)  
 N104 = -5743.58 (FLOAT)  
 N106 = 45.68 (FLOAT)  
 N200 = \_MAXF (100, 4) (FLOAT)

Results of the  
 Floating point number N200 = 6573.458  
 related functions  
 \_MINF, \_AVEF

#### 9. \_AVEF

Take the average of multiple 32-bit symbol points: the return value represents the average of the multiple data  
 INT32S \_AVEF (INT32S regNum, INT32S cnt)  
 regNum can be used in the range 0 ~ 65534  
 Cnt can use the range 1 ~ 128

The 32-bit signed number is used to calculate the average value. Please pay attention to whether the total value overflows.

A return value of 0.0 means that the variable range is wrong or the maximum value is 0.0; other values are the maximum value returned.  
 example:

N100 = 15.64 (DW)  
 N102 = 6573.458 (DW)  
 N104 = -5743.58 (DW)  
 N106 = 45.68 (DW)

N200 = \_AVEF (100, 4) (DW)

Results of the

Floating point number N200 = 222.8

related functions

\_MINF, \_MAXF

## 12.5 Introduction to Time-Related Functions and Syntax

### 12.5.1 A column of time-related functions

Name	Function
_TICK	Get the current time tick value
_TICK2TIME	Time tick value conversion to date and time data
_TIME2TICK	Conversion of date and time data to time tick value

### 12.5.2 Introduction to Time-Related Function Syntax

#### 1. \_TICK

Get the current time tick value: The return value indicates the current time tick value

INT32U \_TICK ()

Parameter: None

example:

N100 = \_TICK () (DW)

N102 = N65448 (DW) // (DW) N65448 has the same function as \_TICK

Results of the

Double word group N100 = 1287635383 // The value varies with time

Double word N102 = 1287635383

related functions

\_TICK2TIME, \_TIME2TICK

#### 2. \_TICK2TIME

Time tick value conversion to date and time data: the return value indicates whether the conversion is successful

INT32U \_TICK2TIME (INT32S destRegNum, INT32U tick)

The range of destRegNum that can be used is 0 ~ 64255. 7 data registers are required to convert data

Tick value entered by tick

The return value 0 indicates that the variable range is incorrect or the conversion fails, and 1 indicates that the conversion is successful.

Conversion register data configuration

0: sec [0 ~ 59]

1: min [0 ~ 59]

2: hour [0 ~ 23]  
 3: day [1 ~ 31]  
 4: month [1 ~ 12]  
 5: year [1970 ~ 2069]  
 6: week [0 ~ 6]

example:

```
N100 = _TICK () (INT32U)
_TICK2TIME (200, (INT32U) N100)
```

Results of the

Double word group N100 = 1277639390 // The value varies with time

N200 = 30 // 30 seconds

N201 = 36 // 36 minutes

N202 = 5 // 5 hours

N203 = 21 // 21st

N204 = 10 // October

N205 = 2010 // 2010

N206 = 4 // Thursday

related functions

\_TICK, \_TIME2TICK

3. \_TIME2TICK

Date and time data is converted to time tick value: the return value indicates the time tick value

INT32S \_TICK2TICK (INT32S destRegNum)

The range of destRegNum that can be used is 0 ~ 64255. 7 data registers are required to convert data

The return value of 0 means that the variable range is wrong or the conversion fails, and the other values are time tick values.

Conversion register data configuration

0: sec [0 ~ 59]  
 1: min [0 ~ 59]  
 2: hour [0 ~ 23]  
 3: day [1 ~ 31]  
 4: month [1 ~ 12]  
 5: year [1970 ~ 2069]  
 6: week [0 ~ 6]

example:

N200 = 30 // 30 seconds

N201 = 36 // 36 seconds

N202 = 5 // 5 hours

N203 = 21 // 21st

N204 = 10 // October

N205 = 2010 // 2010

N206 = 4 // Thursday

N100 = \_TICK2TICK (200) (INT32U)



Results of the

Double word group N100 = 1287639390 // The value varies with time

related functions

\_TICK, \_TIME2TIME

## 12.6 Introduction to Functions and Syntax of Data Conversion

### 12.6.1 List of register functions

Name	Function
_HIBYTE	Variables take high-order metadata
_LOBYTE	Variables take low-order metadata
_HIWORD	Variable takes high byte data
_LOWORD	Variables take low byte data
_SWAPBYTE	Variable high and low bit metadata exchange
_SWAPWORD	Variable high and low byte data exchange
_BIN2GRAY	Convert binary data to Gray code
_GRAY2BIN	Gray code conversion into binary data
_MAKEWORD	Two bits of data combined into one word
_MAKEDWORD	Two words combined into one double word

### 12.6.2 Introduction to Function Syntax

#### 1. \_HIBYTE

Variables take high-order metadata: the return value is the high-order metadata of the input value

INT32U \_HIBYTE (INT32U data)

example:

N100 = \_HIBYTE (1234H)

Results of the

N100 = 0012H

related functions

\_LOBYTE, \_HIWORD, \_LOWORD, \_MAKEWORD, \_MAKEDWORD

#### 2. \_LOBYTE

Variables take low-order metadata: the return value is the high-order metadata of the input value

INT32U \_LOBYTE (INT32U data)

example:

N100 = \_LOBYTE (1234H)

Results of the

N100 = 0034H

related functions

\_HIBYTE, \_HIWORD, \_LOWORD, \_MAKEWORD, \_MAKEDWORD

### 3. \_HIWORD

Variable takes high byte data: the return value is the high byte data of the input value

INT32U \_HIWORD (INT32U data)

example:

N100 = \_HIWORD (12345678H)

Results of the

N100 = 1234H

related functions

\_HIBYTE, \_LOBYTE, \_LOWORD, \_MAKEWORD, \_MAKEDWORD

### 4. \_LOWORD

Variables take low byte data: the return value is the low byte data of the input value

INT32U \_LOWORD (INT32U data)

example:

N100 = \_LOWORD (12345678H)

Results of the

N100 = 5678H

related functions

\_HIBYTE, \_LOBYTE, \_HIWORD, \_MAKEWORD, \_MAKEDWORD

### 5. \_SWAPBYTE

Variable high and low bit data exchange: the return value is the data after the exchange of high and low bits of the input value

INT32U \_SWAPBYTE (INT32U data)

example:

N100 = \_SWAPBYTE (1234H)

Results of the

N100 = 3412H

related functions

\_HIBYTE, \_LOBYTE, \_HIWORD, \_LOWORD, \_MAKEWORD,  
\_MAKEDWORD, \_SWAPWORD

### 6. \_SWAPWORD

Variable high and low byte data exchange: the return value is the data after the exchange of high and low bytes of the input value

INT32U \_SWAPWORD (INT32U data)

example:

N100 = \_SWAPWORD (12345678H)

Results of the

N100 = 1234H

N101 = 5678H

related functions

\_HIBYTE, \_LOBYTE, \_HIWORD, \_LOWORD, \_MAKEWORD,  
\_MAKEDWORD, \_SWAPBYTE

7. \_BIN2GRAY

Convert binary data to Gray code: return the binary data whose input value is converted to Gray code

INT32U \_BIN2GRAY (INT32U data)

example:

N100 = \_BIN2GRAY (55555555H) (DW)

Results of the

N100 = FFFFH

N101 = 7FFFH

related functions

\_GRAY2BIN

8. \_GRAY2BIN

Gray code conversion to binary data: Gray code data whose return value is input value is converted to binary data

INT32U \_GRAY2BIN (INT32U data)

example:

N100 = \_GRAY2BIN (7FFFFFFFH) (DW)

Results of the

N100 = 5555H

N101 = 5555H

related functions

\_BIN2GRAY

9. \_MAKEWORD

Two bits of data combined into one word: the return value is the data combined into one word

INT32U \_MAKEWORD (INT32U hiData, INT32U loData)

example:

N100 = \_MAKEWORD (12H, 34H)

Results of the

N100 = 1234H

related functions

\_MAKEDWORD

## 10. \_MAKEDWORD

Two words combined into one double word: the return value is the data combined into one double word

INT32U \_MAKEDWORD (INT32U hiData, INT32U loData)

example:

N100 = \_MAKEDWORD (1234H, 5678H)

Results of the

N100 = 1234H

N101 = 5678H

related functions

\_MAKEWORD

## 12.7 Introduction to Functions and Syntax Related to

### Calculation Check Code

#### 12.7.1 Column table related functions of calculation check code

Name	Function
_REGLRC	Using LRC method to calculate the variable area check code
_REGCRC1 6	Use CRC16 method to calculate variable region check code
_REGCRC3 2	Use CRC32 method to calculate variable region check code
_REGCCITT	Use the CCITT method to calculate the variable area check code
_REGBCC	Use the BCC method to calculate the variable area check code
_REGBCC2	Use BCC's complement method to calculate the variable area check code

#### 12.7.2 Introduction to the Function Syntax Related to Calculation Check Code

##### 1. \_REGLRC

Use the LRC method to calculate the check code of the variable area: the return value is the value of the LRC check code

INT32S \_REGLRC (INT32S regNum, INT32S cnt)

regNum can be used in the range of 0 ~ 65535

Cnt can be used in the range of 1 ~ 256

The return value 0 indicates that the variable is incorrect or the value is 0, and the other values are the values of the LRC check code.

example:

```

    _STRW (N100, "1234")
    N200 = _REGLRC (100, 4)

```

Results of the

N100 = 0041H

N101 = 0042H

N102 = 0043H

N103 = 0044H

N104 = 0000H

N200 = 202 // 202 = 0CAH

related functions

\_REGCRC16, \_REGCRC32, \_REGCCITT, \_REGBCC, \_REGBCC2

## 2. \_REGCRC16

Use the CRC16 method to calculate the variable area check code: the return value is the value of the CRC16 check code

INT32S \_REGCRC16 (INT32S regNum, INT32S cnt)

CRC16 algorithm ( $X^{16} + X^{15} + X^2 + 1$ )

regNum can be used in the range of 0 ~ 65535

Cnt can be used in the range of 1 ~ 256

The return value of 0 means that the variable is wrong or the value is 0, and the other values are the values of the CRC16 check code.

example:

```

    _STRW (N100, "1234")
    N200 = _REGCRC16 (100, 4)

```

Results of the

N100 = 0041H

N101 = 0042H

N102 = 0043H

N103 = 0044H

N104 = 0000H

N200 = 30BAH

related functions

\_REGLRC, \_REGCRC32, \_REGCCITT, \_REGBCC, \_REGBCC2

## 3. \_REGCRC32

Use the CRC32 method to calculate the variable area check code: the return value is the value of the CRC32 check code

INT32S \_REGCRC32 (INT32S regNum, INT32S cnt)

CRC32 algorithm

$(X^{32} + X^{26} + X^{23} + X^{22} + X^{16} + X^{12} + X^{11} + X^{10} + X^8 + X^7 + X^5 + X^4 + X^2 + X^1 + 1)$

regNum can be used in the range of 0 ~ 65535

Cnt can be used in the range of 1 ~ 256

The return value of 0 means that the variable is incorrect or the value is 0,



and the other values are the values of the CRC32 check code.

example:

```
_STRW (N100, "1234")
N200 = _REGCRC32 (100, 4) (DW)
```

Results of the

N100 = 0041H

N101 = 0042H

N102 = 0043H

N103 = 0044H

N104 = 0000H

Double word N200 = 09BE3E0A3H

related functions

\_REGLRC, \_REGCRC16, \_REGCCITT, \_REGBCC, \_REGBCC2

#### 4. \_REGCCITT

Use the CCITT method to calculate the variable area check code: the return value indicates the value of the CCITT check code

INT32S \_REGCCITT (INT32S regNum, INT32S cnt)

CRC-CCITT algorithm ( $X^{16} + X^{12} + X^5 + 1$ )

regNum can be used in the range of 0 ~ 65535

Cnt can be used in the range of 1 ~ 256

The return value 0 indicates that the variable is incorrect or the value is 0, and the other values are the values of the CCITT check code.

example:

```
_STRW (N100, "1234")
N200 = _REGCCITT (100, 4)
```

Results of the

N100 = 0041H

N101 = 0042H

N102 = 0043H

N103 = 0044H

N104 = 0000H

N200 = 9741H

related functions

\_REGLRC, \_REGCRC16, \_REGCRC32, \_REGBCC, \_REGBCC2

#### 5. \_REGBCC

Use the BCC method to calculate the check code of the variable area: the return value indicates the value of the BCC check code

INT32S \_REGBCC (INT32S regNum, INT32S cnt)

regNum can be used in the range of 0 ~ 65535

Cnt can be used in the range of 1 ~ 256

The return value of 0 means that the variable is incorrect or the value is 0, and the other values are the values of the BCC check code.

example:

```
_STRW (N100, "1234")
N200 = _REGBCC (100, 4)
```

Results of the

N100 = 0041H

N101 = 0042H

N102 = 0043H

N103 = 0044H

N104 = 0000H

N200 = 0004H

related functions

\_REGLRC, \_REGCRC16, \_REGCRC32, \_REGCCITT, \_REGBCC2

## 6. \_REGBCC2

Use the BCC's complement method to calculate the variable area check code: the return value is the value of the BCC's complement check code

INT32S \_REGBCC2 (INT32S regNum, INT32S cnt)

regNum can be used in the range of 0 ~ 65535

Cnt can be used in the range of 1 ~ 256

The return value of 0 means that the variable is incorrect or the value is 0, and the other values are the values of the BCC check code.

example:

```
_STRW (N100, "1234")
N200 = _REGBCC2 (100, 4)
```

Results of the

N100 = 0041H

N101 = 0042H

N102 = 0043H

N103 = 0044H

N104 = 0000H

N200 = 00FBH

related functions

\_REGLRC, \_REGCRC16, \_REGCRC32, \_REGCCITT, \_REGBCC

## 12.8 Introduction to Communication Related Functions and

### Syntax

#### 12.8.1 A column table of communication-related functions

Name	Function
_LWRITE	Data is sent through the communication port

## 12.8.2 Introduction to Communication Related Function Syntax

### 1. \_LWRITE

Data is sent through the communication port: the return value indicates whether the sending is completed

INT32S \_LWRITE (INT32S handle, INT32S regNum, INT32S cnt)

Operation value of the handle communication connection (Handle is displayed after the [Link Management] parameter in the Link Management window)

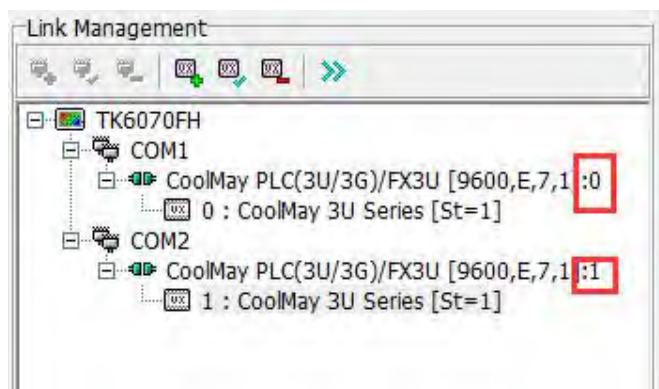

regNum data source register address number

Cnt can use the range 1 ~ 256

The return value 0 means that the variable range is wrong or the handle is wrong or there is a problem with the development.

example:

```
_STR (1000, "A0 = 1234 \r \n")
```

```
N100 = _STRLEN (1000)
```

```
N101 = _LWRITE (0, 1000, N100)
```

Results of the

The character string is sent through the communication port "A0 = 1234 \r \n"

```
N100 = 9
```

```
N101 = 1
```

## Chapter 13 Description of Macro Communication

Using Macro communication, when the communication receives data, the system will automatically execute [496: Sub Macro (496)] without calling it.

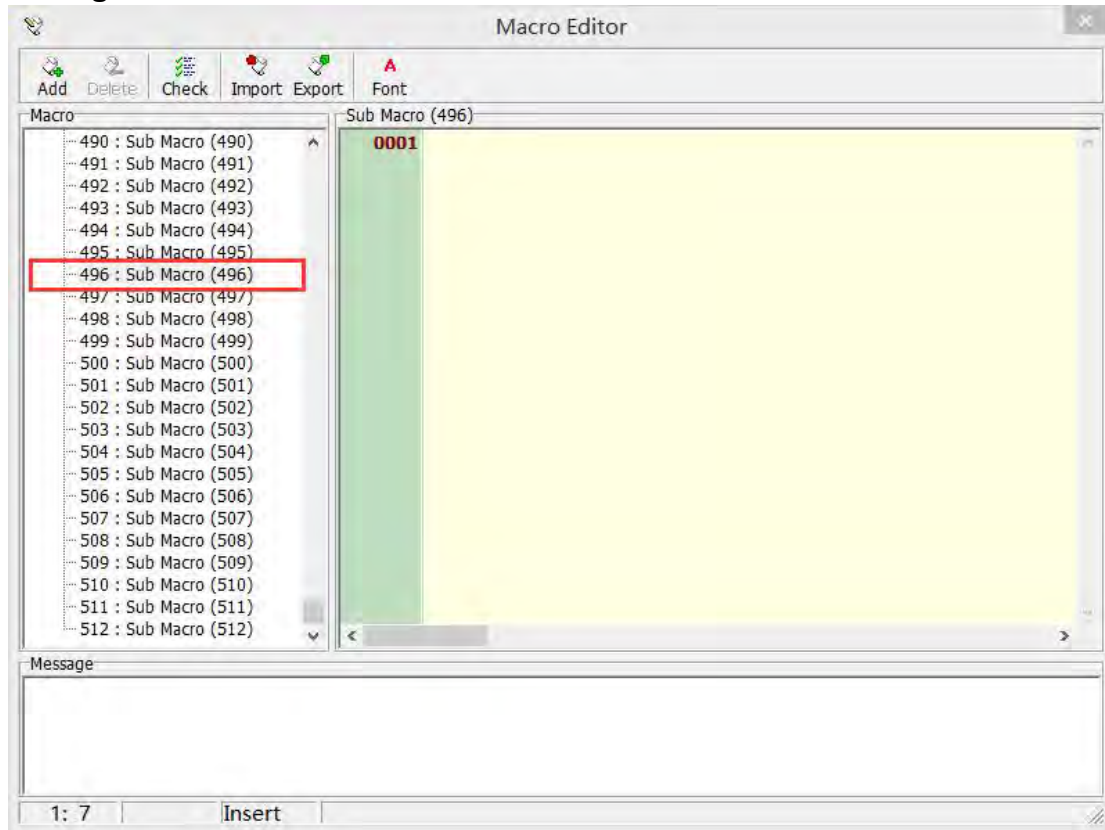

Receive data and send data is up to 253 bytes (Byte).

N63744 [0xf900] Length of received data (BYTE). (0 ~ 253)

N63745 ~ N63871 Received data The received data is stored from the lower byte, that is, the first BYTE stores the lower 8 bits of N63745, the second BYTE stores the upper 8 bits of N63745, and so on.

When the system receives the data from the communication port, it will store the data in sequence to N63745, and store the number of bytes received to N63744.

N63872 [0xf980] Length of data to be transmitted (BYTE). (0 ~ 253)

N63873 ~ N63999 Transmitted data The transmitted data is stored from the lower byte, that is, the first BYTE stores the lower 8 bits of N63873, the second BYTE stores the upper 8 bits of N63873, and so on.

When the system recognizes that N63872 is greater than 0 and less than 254, it will begin to transmit the data at the variable position of N63873 to the number of bytes recorded by N63872. Commands sent twice. (When data is

sent to the communication buffer, the system will sequentially send the data to the corresponding communication port)

**Note: The Macro communication protocol does not support the simultaneous use of multiple communication ports.**



## Appendix 1 Definition of mView Project Editing

### Keyboard

keyboard	action	remark
Ctrl+Z	Undo the last action	
Ctrl+Shift+Z	Undo last action	
Ctrl+X	Cut	
Ctrl+C	copy	
Ctrl+M	Multiple copy	
Ctrl+V	paste	
Ctrl+Del	delete	
Del	delete	
Ctrl+A	select all	
Up	Component fine-tuning	
Down	Component fine-tuning	
Left	Component fine-tuning to the left	
Right	Components fine-tuned to the right	
Shift+Up	The component moves up one grid	
Shift+Down	Move the component down one grid	
Shift+Left	Move the component one frame to the left	
Shift+Right	Move the component one space to the right	
Ctrl+Up	Reduced component height by one	
Ctrl+Down	Increase the component height by one	
Ctrl+Left	Component width minus one	
Ctrl+Right	Increase the component width by one	
ESC	cancel selection	
G	Group	
U	Ungroup	

I	Enlarged display	
O	Zoom out	
L	Fixed element	
Space	Edit symbol	
F4	Display component order	
Shift+F4	Display component name	
F5	Display variables (simple)	
Shift+F5	Display variables (general)	
F6	Only display information about selected components	
F8	Grammar check	
F9	Online execution	
Shift+F9	Offline execution	
Ctrl+F9	Stop	
Ctrl+Alt+S	Download to HMI	
Shift+"+"	Change the order of components (to the top)	
Shift+"-"	Change the order of components (to the bottom)	
"+"	Change component order (up one layer)	
"_"	Change component order (push back one layer)	

## Appendix 2 List of mView System Preset Variables

The user-available variable range is N0~N65023, and the register range for power interruption is N49152~N61439 (will be expanded to N32768~N49151 in the future). Note that the variables after N65024 are for system use and cannot be customized by users.

### 1 System preset variables

Power off retentive

No.	data	Explanation	Default value	Read and write
N65024	Screen brightness	0...100	70	R/W
N65025	Screen comparison	0...100	50	R/W
N65026	Backlight timer	Unit: second, 30...65535, 65535=off	65535	R/W
N65027	volume	0...100	100	R/W
N65028	Power LED status display	0=flash, 1=stop	0	R/W
N65029	Signal generator switch	0=off, 1=on	0	R/W
N65030	Key sound index	65535=off	0	R/W
N65031	Dialog box sound index	65535=off	1	R/W
N65040	Auxiliary cursor	65535=off	65535	R/W
N65041	Auxiliary cursor color		0	R/W
N65044	Dialog box mask	Use dialog mask 0X0001, 0X0002 omit the background picture	1	R/W
N65048	Screen brightness increase rate	1...20	10	R/W
N65049	Screen brightness reduction rate	1...20	2	R/W
N65050	Backlight power saving ratio	0...100	0	R/W

N65056	Time zone	-32768...32767	0	
N65072	Com port 1 is connected to electrical	0-auto recognition RS232/RS422/RS485 1-RS232 2-RS422 3-RS485	0	
N65073	Com port 1 communication rate	0-150,3-1200,6-9600,9-57600, 1-300,4-2400,7-19200,10-115200, 2-600,5-4800,8-38400,	10	
N65074	Com port 1 data bit	0 - 5bit, 1 - 6bit, 2 - 7bit, 3 - 8bit	3	
N65075	Com port 1 check bit	0 - None, 1 - Odd parity, 2 - Even parity, 3 - mark, 4 - Space	0	
N65076	Com port 1 stop bit	0 - 1bit, 1 - 2bit,	0	
N65077	Com port 1 delay	Unit: ms	20	
N65078	Com port 1 timeout setting	Unit: millisecond, minimum value 1000	1000	
N65080	Com port 2 connected to electrical	Setting as N65072	0	
N65081	Com port 2 communication rate	Setting as N65073	10	
N65082	Com port 2 data bit	Setting as N65074	3	
N65083	Com port 2 check bit	Setting as N65075	0	
N65084	Com port 2 stop bit	Setting as N65076	0	
N65085	Com port 2 delay	Unit: ms	20	
N65086	Com port 2 timeout setting	Unit: millisecond, minimum value 1000	1000	
N65088	Com port 3 connected to electrical	Setting as N65072	0	
N65089	Com port 3 communication rate	Setting as N65073	10	
N65090	Com port 3 data bits	Setting as N65074	3	
N65091	Com port 3 check bit	Setting as N65075	0	

N65092	Com port 3 stop bit	Setting as N65076	0	
N65093	Com port 3 delay	Unit: ms	20	
N65094	Com port 3 timeout setting	Unit: millisecond, minimum value 1000	1000	
N65096	Com port 4 connected to electrical	Setting as N65072	0	
N65097	Com port 4 communication rate	Setting as N65073	10	
N65098	Com port 4 data bits	Setting as N65074	3	
N65099	Com port 4 check bit	Setting as N65075	0	
N65100	Com port 4 stop bit	Setting as N65076	0	
N65101	Com port 4 delay	Unit: ms	20	
N65102	Com port 4 timeout setting	Unit: millisecond, minimum value 1000	1000	
N65104	Flashing time setting 1	Unit: ms	1000	
N65105	Flashing time setting 2	Unit: ms	500	
N65106	Flashing time setting 3	Unit: ms	200	
N65107	Flashing time setting 4	Unit: ms	100	
N65112	Dialog box input effect	0=off, 1=on.	1	
N65116	Component enable display	0: Normal display, 1: When the enabling condition is not established, the [Prohibition] symbol is displayed on the upper left. 2: When the enabling condition is not established, the module sets the network type shielding pattern		
N65120	RFID_MODE	RFID reading mode 0=Read UID, 1=Read UID+IID, 2=Write IID		
N65128	MODBUS slave station number			
N65137	Screen language	Bit0=1: Record the current		



	options	language		
N65152	Macro options			
N65168	Adjust column height			
N65264	Last boot state	0=Normal, ! =0 wrong	0	

## Working temporary register(R/W)

No.	Data	Explanation	Read/write
N65280	Perpetual calendar-year	1960...2059	R/W
N65281	Perpetual calendar-month	1...12	R/W
N65282	Perpetual calendar-day	1...31	R/W
N65283	Perpetual calendar-hour	0...23	R/W
N65284	Perpetual calendar-minute	0...59	R/W
N65285	Perpetual calendar-second	0...59	R/W
N65286	Perpetual calendar-week	0...6, 0=Sunday, 6=Saturday	R/W
N65287	Current backlight time	0...65535	R/W
N65288	Dialog box result		R/W
N65289	Dialog box data format		R/W
N65290	Dialogue box decimal point		R/W
N65291	Number of dialog boxes		R/W
N65292	Maximum number of text in dialog box		R/W
N65293	Dialog box button clear	0X8000(Loop input0X00FF)	R/W
N65294-N65295	Dialogue text		R/W
N65296-N65327	Dialog box text		R/W
N65328-N65329	Enter the maximum value		R/W

N65330-N65331	Enter the minimum value		R/W
N65332	Right to use password dialog box		R/W
N65340	Current user rights	1...31	R/W
N65341	Current user ID	1...15	R/W
N65342	Current screen language index	0...n	R/W
N65343	Current screen ID	1...n	R/W
N65344	Current key status	0...3	R/W
N65345	Input disable		R/W
N65347	Control register	Bit=0 Update the current backlight timing	R/W
N65360-N65375	Dialog box input max string	Display data format2: -A	R/W
N65376-N65391	Dialog box input min string	Display data format2: -A	R/W

## Working read-only register

No.	Data	Explanation	Read/wirte
N65408	HMI Model	0X5000	R
N65409	OS Version		R
N65410	Screen width	320	R
N65411	Screen height	240	R
N65412	Screen color	1/4/8/16	R
N65413	screen size	5700	R
N65414	Product Number 1		R
N65415	Product Number 2		R
N65422	Screen update time	Unit: ms	R
N65423	Picture updates per second		R
N65424	CPU Usage rate	0...100	R
N65430	Type of alarm occurrence information	0...2	R
N65431	Alarm storage capacity		R
N65432	Number of alarms		R
N65440	System Information Number		R

N65448-N65449	Time TICK		R
N65456-N65463	protocol name of com port 1	Display format 1-BA display length 16	R
N65464-N65471	protocol name of com port 2	Display format 1-BA display length 16	R
N65472-N65479	protocol name of com port 3	Display format 1-BA display length 16	R
N65480-N65487	protocol name of com port 4	Display format 1-BA display length 16	R
N65488	COM1Number of write buffers	At present, each COM port has 32 write buffers	R
N65489	COM2Number of write buffers	At present, each COM port has 32 write buffers	R
N65504	Signal generator1	[0...359]	R
N65505	Signal generator2	[0...99]	R
N65506	Signal generator3	[0...11]	R
N65507	Signal generator4	[0...59]	R
N65508	Signal generator5	Sine wave[0...327687]	R
N65509	Signal generator6	Sawtooth wave[0...327687]	R
N65510	Signal generator7	Triangle wave[0...327687]	R
N65511	Signal generator8	Square wave[0...327687]	R
N65528	Communication abnormal alarm	Bit0=COM1,Bit1=COM2.	R
N65529	Boot time status	Bit0 = 1 after booting, Bit1 = 1 after 1 second, Bit15 = 1 at the 15th second.	R

## 2 The usage of internal pointer variable V

The pointer V and the variable N appear in pairs, and the fixed relationship is as follows

<b>Pointer V</b>	V0	V1	V2	V3	V4	...	V32765	V32766	V32767
<b>Variable N</b>	N0	N1	N2	N3	N4	...	V32765	V32766	V32767

In mView, the relationship between the internal variable pointer V and the variable N is one-to-one. When using it, you need to follow the corresponding relationship in the above table. If you use V0, the other needs to use N0, and so on...

Among them, the value of N represents the address that points to the register, and the value of V represents the value of the register pointed to by N; for example: use the group N0 and V0 for indexing, N0=100, N100=255, then V0=255.

Examples of batch assignment:

```
N0=10  
FOR 61430  
V0=555(INT16U)  
N0+=1(INT16U)  
NEXT  
END
```

Analysis: N0=10, the register that specifies the start of the index is N10;  
V0=555, specify the value to be transmitted, that is, N10=V0=555;  
Use the FOR loop program to assign all values of 555 to N10-N61439.

## Appendix 3 mView Scale Frequency Table

scale		Octave0	Octave1	Octave2	Octave3
Do	C	262	523	1047	2093
	Db	277	554	1109	2217
Re	Db	294	587	1175	2349
	Eb	311	622	1245	2489
Mi	Eb	330	659	1329	2637
Fa	F	349	698	1397	2794
	Gb	370	740	1480	2960
Sol	G	392	784	1568	3136
	Ab	415	831	1661	3322
La	A	440	880	1760	3520
	Bb	466	923	1865	3729
Si	B	494	988	1976	3951



## Appendix 4 Instructions for Using Operation

### Variables

Operation variable

It means that the general numerical data source location can be set using the calculation between variables.

In this software, if a small icon appears on the right side of the edit box for the input variable position, it means that the variable input position can use arithmetic variables. As shown below:

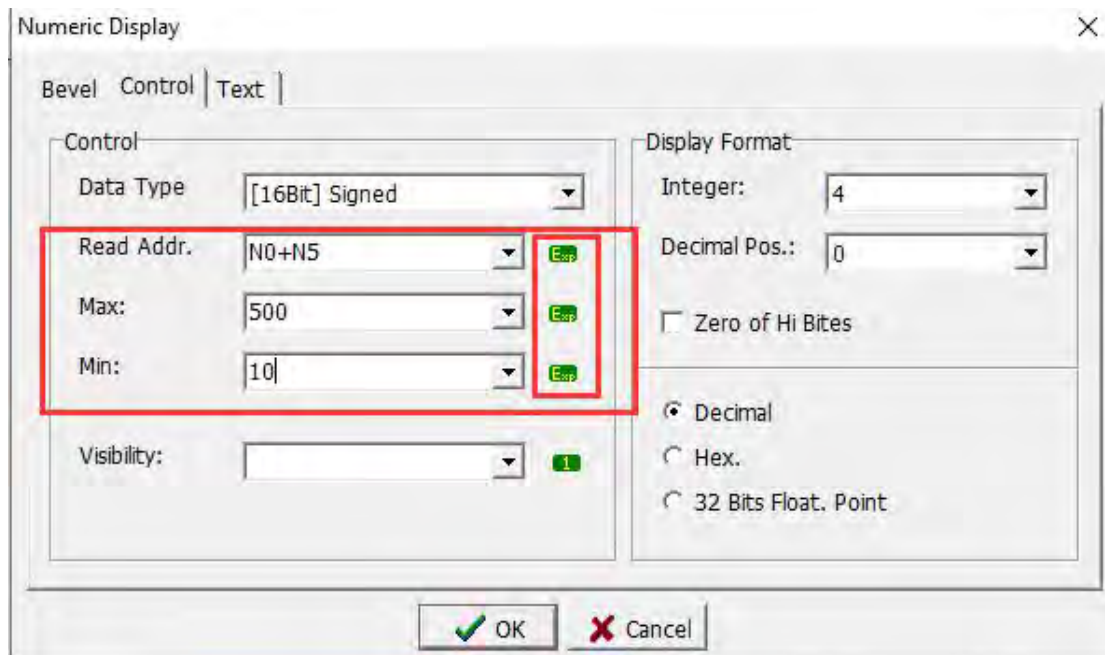

The operational symbols that can be used are shown in the table below

Operation category	Operation	symbol	Case	remarks
computation	addition	+	D100 + D101	
	Subtraction	-	D100 - D101	
	multiplication	*	D100 * D101	
	Descent	/	D100 / D101	
	Take the remainder	%	D100 % D101	
	Take a negative number	-	-D101	
Bit operation	and	&	D100 & D101	
	XOR	^	D100 ^ D101	
	or		D100   D101	
	Shift left	<<	D100 << D101	
	Right shift	>>	D100 >> D101	

	Negate	~	~D100	
Relational operation	Equal to	==	D100 == D101	
	Not equal to	!=	D100 != D101	
	Less than	<	D100 < D101	
	Less than or equal to	<=	D100 <= D101	
	more than	>	D100 > D101	
	More or equal to	>=	D100 >= D101	
logic operation	Logical OR		D100    D101	
	Logical AND	&&	D100 && D101	
	Logical inverse	!	!D100	

In the table above:

D100 and D101 refer to variables in the PLC (controller).

Operators can be used together, for example  $((D100 + D101) / 2) == 100$

To increase the convenience of reading, when the operator occupies a bit, a space can be inserted between the variable and the operator. However, when the operator occupies two bits, no space can be added between the operators, as explained below:

D100 + D101 can be written: D100 + D101

D100 <= D101 The syntax check is correct here

D100 < = D101 The syntax check is incorrect here because the operator < = has a blank character in the middle.

#### Definition of constant

Constant type	Definition description	Case
Decimal	Number0~9	123 or 100000
Hex	Numbers 0 ~ 9, English letters A ~ F, the last word is 'H', but the first word must not be a letter, it must be a number	100H or 1234H or 0ABCDH

#### Cases

Operation variable	Explanation
$(D0+D1+D2+D3+D4)/5$	Take the average of D0 to D4
$(D0+1234)/1000$	Multiply D0 by 1.234
$(D0==100H)   (D1==200H)$	When D0 is equal to 100 in hexadecimal or D1 is equal to 200 in hexadecimal, the value is 1, otherwise the value is 0.
$D0>D1$	When D0 is greater than D1, the value is 1, otherwise the value is 0
$(D0<=D1) \&\& (D0==100)$	When D0 is less than D1 and D0 is equal to 100, the value is 1, otherwise the value is 0.

D0 & D1	D0 = [Binary] 000000000001111-> Decimal = 15 D1 = [Binary] 000000000010001-> Decimal = 17 D0 & D1 = [Binary] 000000000000001-> Decimal = 1
D0 << 2	D0 = [Binary] 000000000001111-> Decimal = 15 D0 << 2 = [Binary] 000000000111100-> Decimal = 60

## Appendix 5 Function Description of Multiple Intelligent Connected Machines of HMI

At present, more users will have more and more devices connected to the HMI. One RS485 can be connected to multiple controllers. Under this structure, the software can distinguish each controller by station number when designing the HMI program stage, so that the HMI can read the data of each connected controller. When each controller works normally, the communication will work normally.

However, in some use cases, not all connected controllers must be powered on, which will cause the HMI to always try to connect with the controller that is not powered on during communication, which will affect the overall communication speed.

When we designed the software, we added the [multiple intelligently connected machines] function in the HMI software, and the setting page is shown in the following figure:

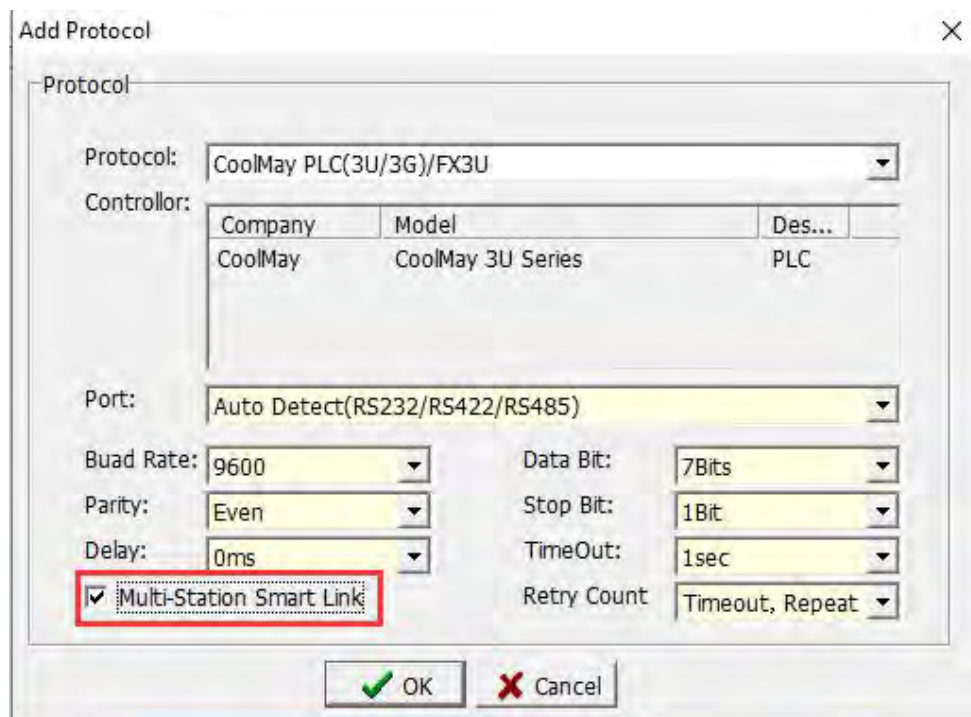

[Multi-Station Smart Link] function basically records the connection status of each controller to adjust the communication parameters and increase the connection speed and stability. When the unpowered controller restarts, the HMI will automatically discover and connect automatically.

The station number must be between 0 and 31 when the station number of the controller is assigned by using the function of [Multiple Smart Links]. If you need to know the status of the connected controller, you can check it from HMI

internal system variables (COM1 = N65352, COM2 = N65354).

The station number corresponds to the bit of the variable, 0 = normal connection, 1 = not currently connected. The specific corresponding table is as follows.

COM1	Variable	N65353														N65352																	
	bit	15	14	13	12	11	10	9	8	7	6	5	4	3	2	1	0	15	14	13	12	11	10	9	8	7	6	5	4	3	2	1	0
	Station No	31	30	29	28	27	26	25	24	23	22	21	20	19	18	17	16	15	14	13	12	11	10	9	8	7	6	5	4	3	2	1	0

COM1	Variable	N65355														N65354																	
	bit	15	14	13	12	11	10	9	8	7	6	5	4	3	2	1	0	15	14	13	12	11	10	9	8	7	6	5	4	3	2	1	0
	Station No	31	30	29	28	27	26	25	24	23	22	21	20	19	18	17	16	15	14	13	12	11	10	9	8	7	6	5	4	3	2	1	0

Note: [Multiple Smart Links] only supports controllers with station number communication protocol.



## Appendix 6 Function Description of Embedded Numerical Value Display in String

The value embedded in the character string means that when a static text component is used, the dynamic variable character string value is displayed in a general static component using the [variable display character string] function.

[Variable display character string]: Refers to the definition character string that uses '{' as the starting symbol and '}' as the ending symbol. For example {N0,4.2d}, {N100,81X}.

If you want to display the '{' symbol in the character string, you need to type two consecutive '{' 's of '{{' to recognize the '{' as a normal character string.

[Variable display string] The definition is divided into 6 parts: prefix, variable definition part, integer part, decimal part, display format definition, suffix. The variable definition part and the integer part are separated by a ',' comma (English comma).

Variable display string format description					
Prefix	Variable definitions	Integer part	decimal part	Display format definition	suffix
{	System variables N0 ~ N65535 Index variable V0 ~ V255	Value: 1-12. When high-order zero padding is required, add a number '0' in front.	Value: 1-12. If this bit is 0, that is, the fractional part is not needed, this bit can be omitted. When it is omitted, the separator "." With the integer part needs to be deleted.	d: Decimal signed number (16Bits) u: decimal unsigned number (16Bits) x: Hexadecimal display (16Bits) ld: Decimal signed number (32Bits ※) lu: decimal unsigned number (32Bits ※) lx: hexadecimal display (32Bits ※) f: floating point display (32Bits ※)	}
Note: There can be no white space in the variable display string definition					
※ The reading of 32Bits is lower 16-bit data, and higher 16-bit data.					

Examples of variable display string settings:

In {N0,4.2d},

Prefix: {;

Variable definition: N0;

Integer part: 4;

Decimal part: 2;  
 Display format: d;  
 Suffix:}

An example of variable display character string display, taking decimal N0 = 123 as an example:

Set variable display string	display	Explanation
{N0,04x}	007B	Display the value of N0 in the form of hexadecimal high-order zero-filling
{N0,2.2d}	1.23	Display the value of N0 in decimal and 2 decimal places
{N0,d}	123	Display the value of N0 in decimal format

Examples of software settings:

1. Newly added components [static text]



2. Set the [Label] property as shown below

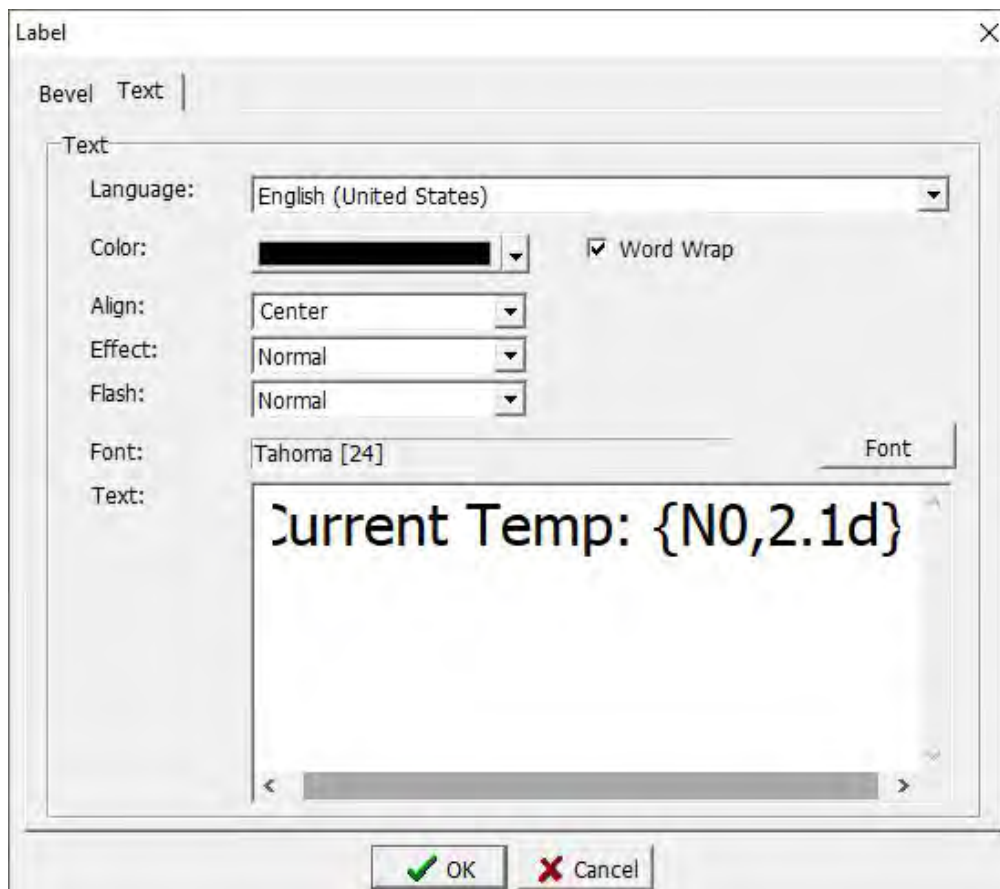

3. [Static text] The display status is shown as below

A screenshot of an HMI display showing the text "Current Temp: {N0,2.1d}" in a black font. The background of the display area is a gradient from light blue at the top to light orange at the bottom.

4. Executing the program, the display status of [static text] is shown in the figure below

A screenshot of an HMI display showing the text "Current Temp: 29.8" in a black font. The background of the display area is a gradient from light blue at the top to light orange at the bottom.

## Appendix 7 List of Communicable Controllers

518 Singlex Series
AD-4401 Series
Allen-Bradley DH-485
ARCUS Series
CoolMay PLC(2N)
CoolMay PLC(3U/3G)/FX3U
CSIM Series
DELTA DVP Series
DPS Series
Facon FB Series
Fama Series
Fuji MICREX-SX Series
GALIL Series
Jing Yi elevator Series
Keyence KV Series
Koyo K sequence
LG Master-K K120S Series
LUSTBUS Series
Macro Series
Matsushita FP Series
Mitsubishi A1SH Series
Mitsubishi FX Series
Mitsubishi FX Series-Computer link
Mitsubishi FX2N Series
Mitsubishi FX2N-10GM/20GM Series
Mitsubishi FX3U Series
Mitsubishi MR-J2S Series
Mitsubishi MR-J3 Series
Mitsubishi MR-J4 Series
Mitsubishi Q Series
Mitsubishi Q06HCPU Series
Mitsubishi QnA Series
Modbus ASCII Mode
Modbus RTU Mode
Omron C Series
Omron CompoWay
P900 Series
Phoenixtec UPS Series

RM80 Series
SAMCO-Vm05 Series
Simatic S7-200 Series
SMAC LLC-10 Series
SmartMotor Series
TAIE Series
TECORP HC1 Series(ASCII Mode)
TECORP V5000 Series
TOHO TTM-004/X04 Series
TRIO Host link Series
Unidriver Series
UNIPULSE Series
VIGOR M/VB/VH Series
WDH IR-BOX Series
WDH Lamp Series
XP989 Series
Yamatake CPL



## Appendix 8 TK Series HMI Storage Data export

### Operation Instruction

#### Software: xExpress

xExpress software is specially designed for mView TK series HMI. The main function is to read the recipe data and record data of the TK series HMI in operation through the communication port, and save it as a text file, which is convenient for customers to further data analysis or make reports, output data can be customized display format, so that the data display closer to actual use.

#### Simple operation steps

1. Edit mView software, design HMI program, and define recipe data or record data.
2. Test the connected HMI program to confirm that is working properly.
3. Use mView software to export [cache definition export].
4. Open xExpress editor, connect device and communication parameters.
5. Import data definition (the file exported by step 3).
6. Read the data in the buffer area through the connection
7. Select the edited recipe or recorded data, and after editing the attributes, export the data to a text file.
8. Use Microsoft Excel software to open text documents, and then do data analysis and reports.

#### Step1

First of all, use mView to edit the HMI program. When the recipe data or record data is used in the program, it can be used with xExpress software.

Note that editing recipe data [backup device: use system variable area (N0-N61439)]

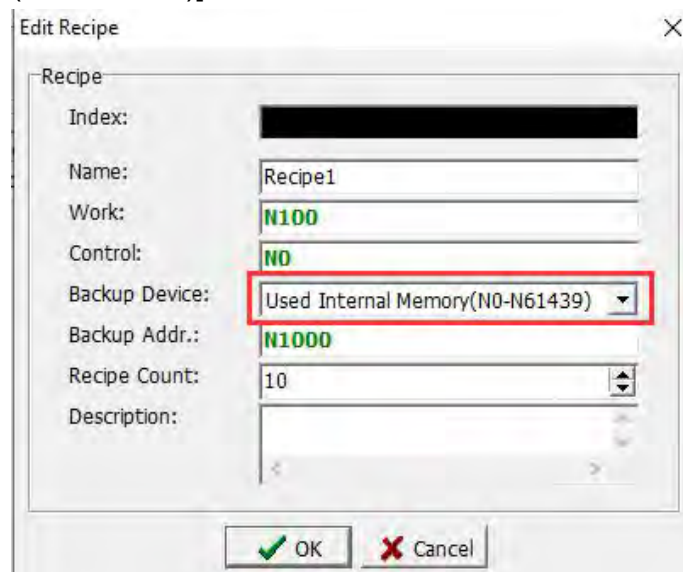

Note that editing record data needs [retentive function]

Note: The maximum power-saving interval is 49152 words, which is related to [Data Length] and [Record Count]

**Edit Data Record**

Data Record

Name: ProductManagement

Data Type: [16Bit] Signed

Source: D10

Data Length: 4

Record Count: 5000 Range 1 .. 32767

Update Time: 2Sec

Record Flag: M0

Clear Flag: M1

Clear[Clear flag]

Stop Count: 0 Auto. stop as touch record setting, No use this function

Description:

Record Date/Time

Retentive 30004 Word

Use Reg. Addr.: NO - N30003

Provide hold Reg. N0-N49151(49152Word), Only Advance HMI.

OK Cancel

### Step2

Download the program to the HMI test operation until the test operation is confirmed to be normal.

### Step3

Open the mView software to edit the HMI program, select [File]-[Export]-[Register Define] to store the buffer definition file.

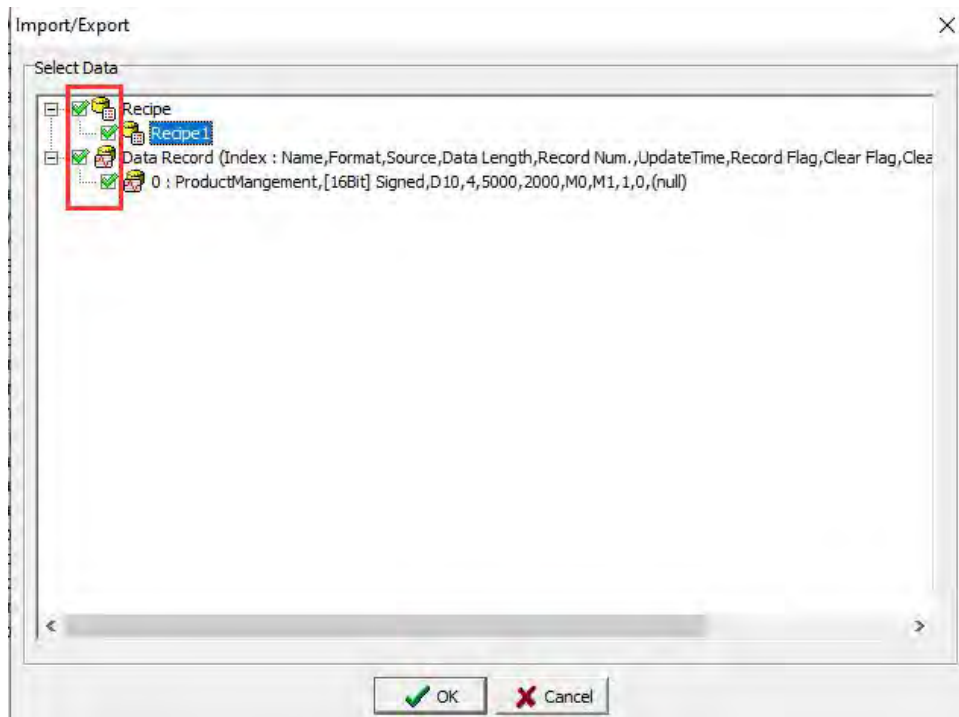
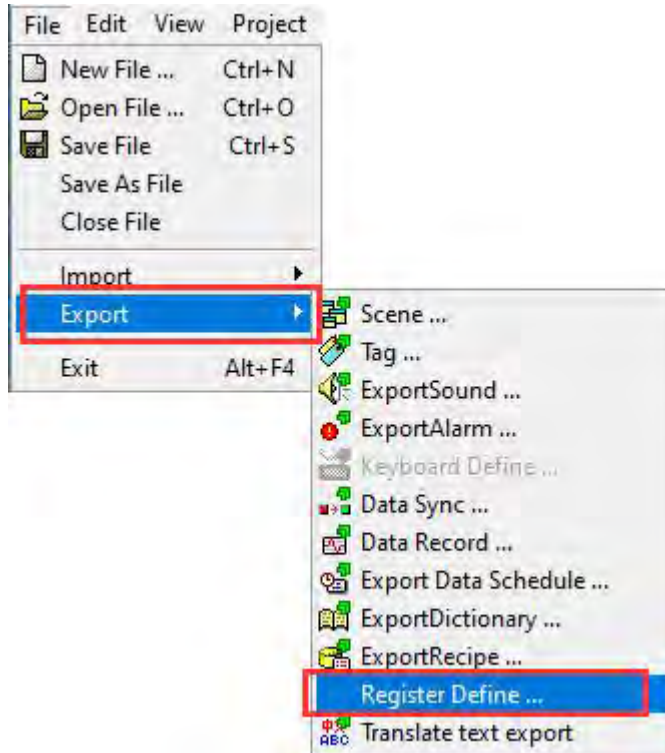

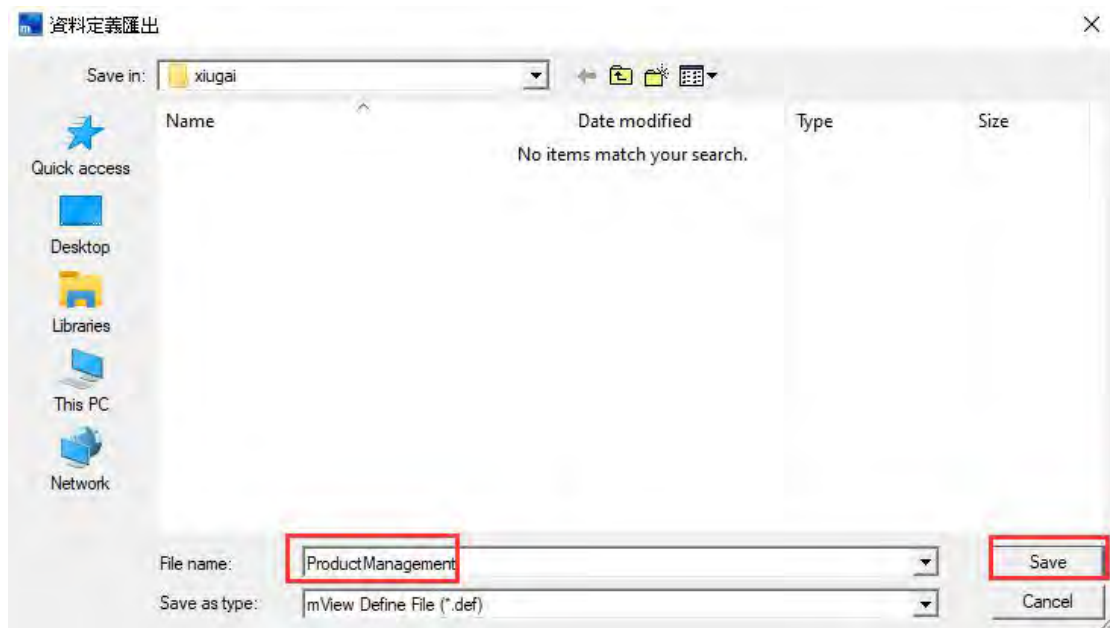

#### Step4

Open the xExpress software, [File]-[Open a new file], press the [Add Device] button in the lower right corner

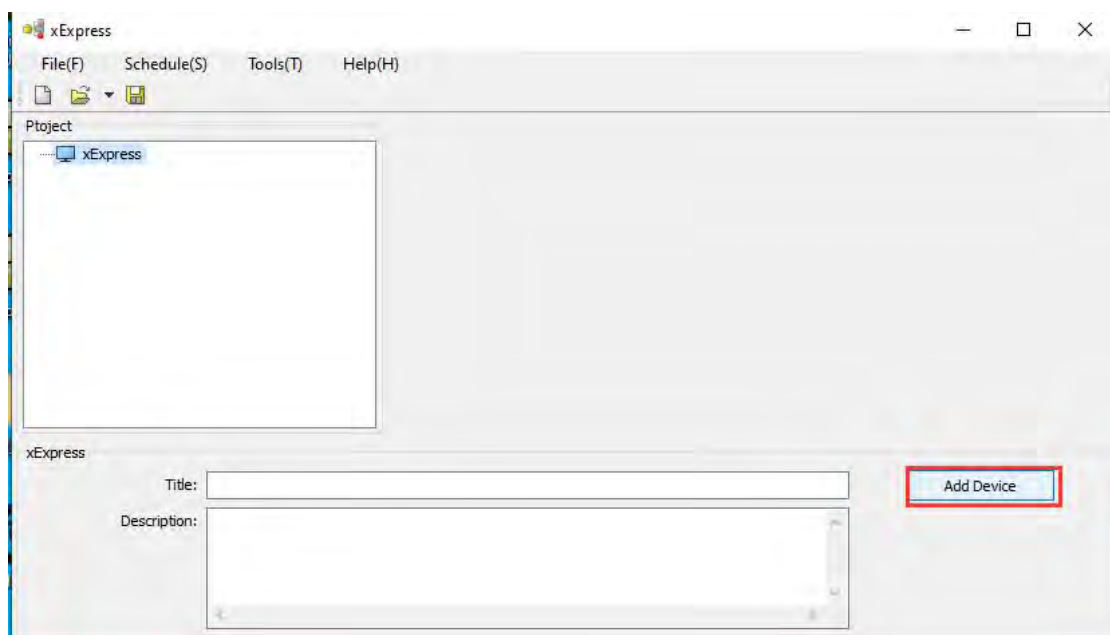

This demo explain how to use com port to communication, after adding a

device, please select the communication port; [device] parameter refers to the com port between the PC and the HMI, and set the communication parameters (default 115200, 8, none, 1 is enough)

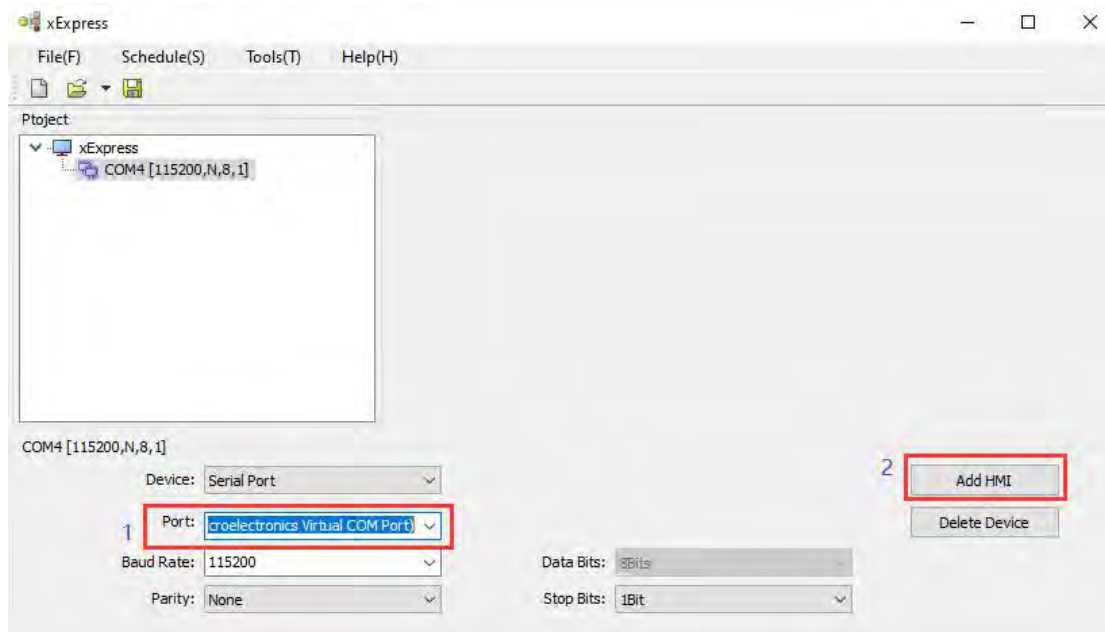

Then click [Add HMI] to add an new HMI

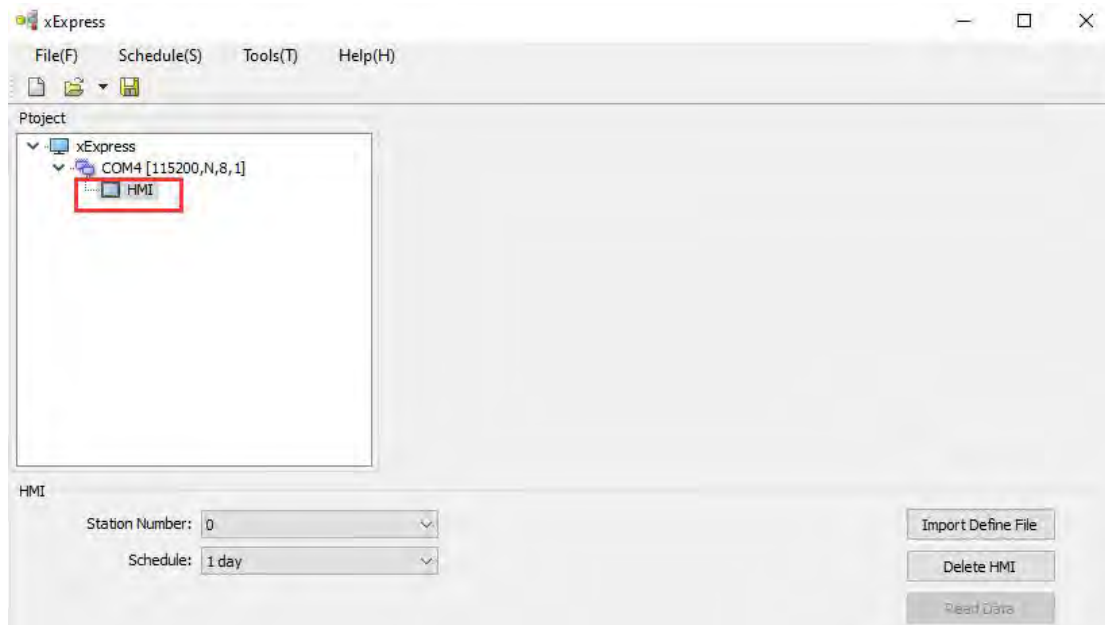

### Step5

After adding the HMI, you need to import the data definition (defined by the buffer exported in step 3)



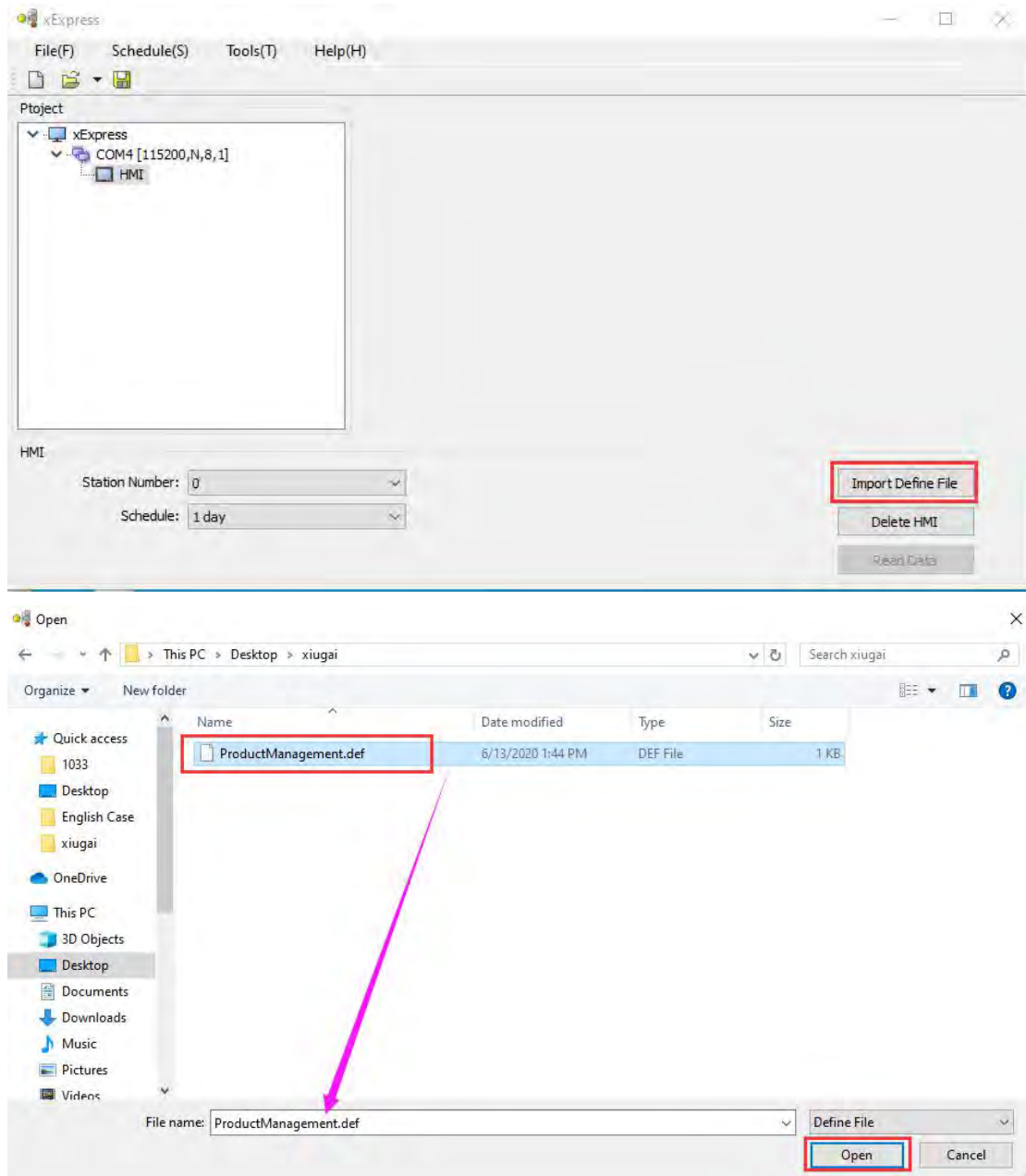

### Step6

The definition data of the HMI will record the data definition. After the data definition is imported, please fix the connection line between the PC and the HMI (the download line of the HMI) and press [Read Data] on the lower right corner of the xExpress screen to start reading the HMI. data

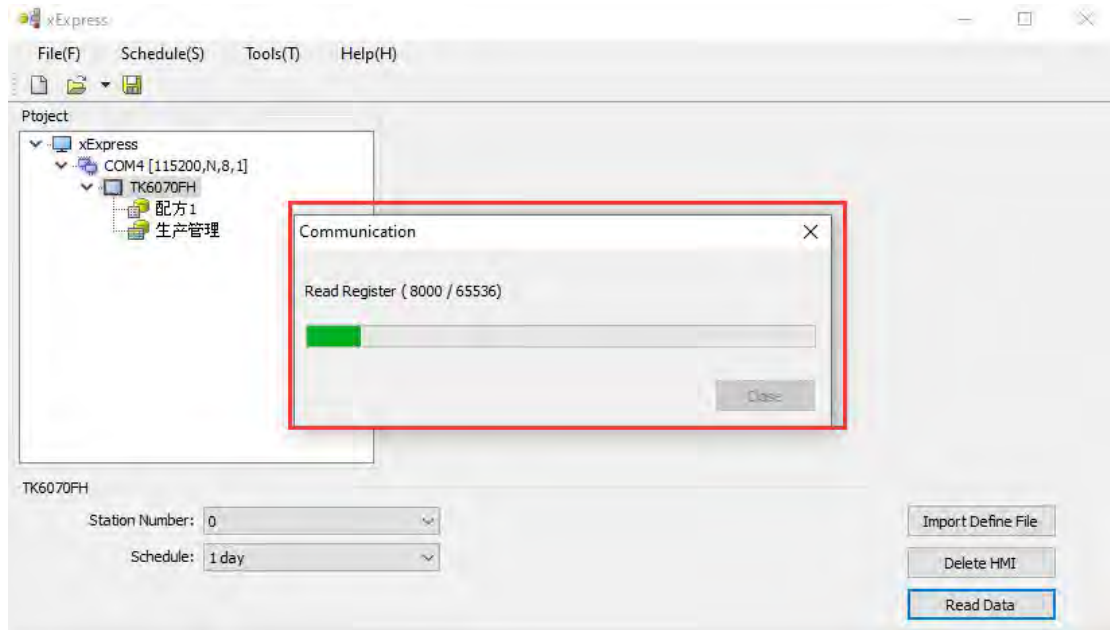
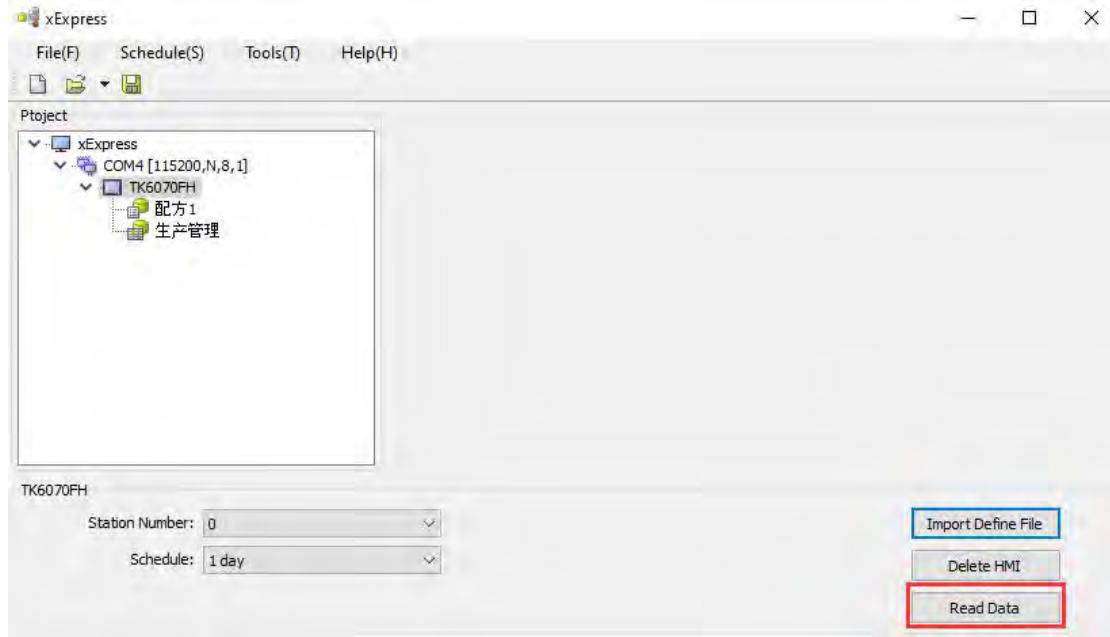

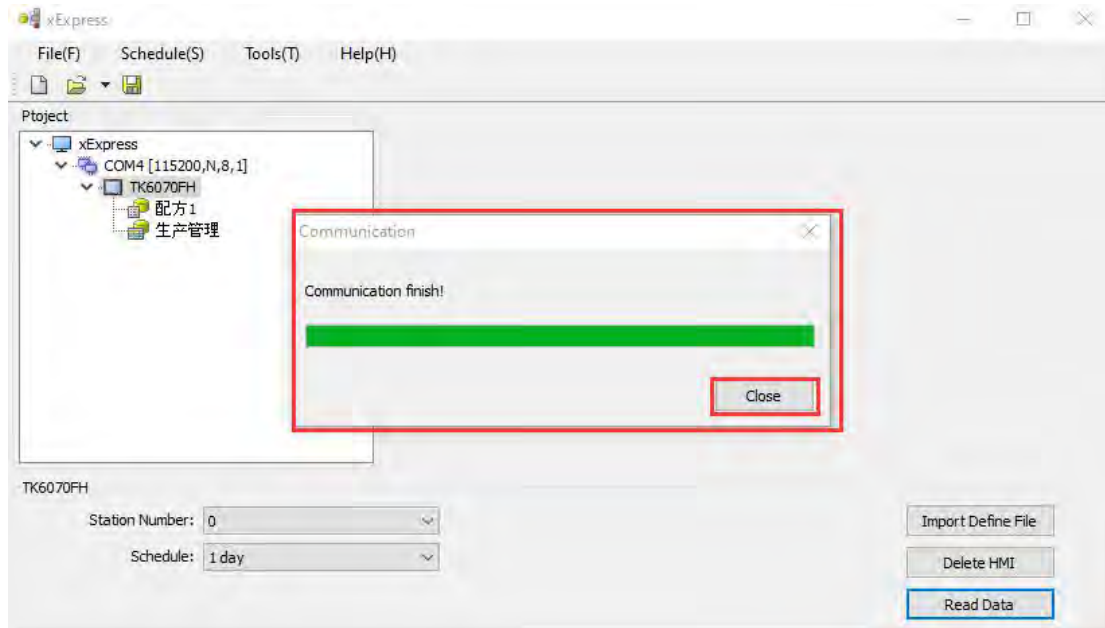

## Step 7

At this time, the recipe data or recorded data has been read back to the PC, select the edited recipe or record data, after editing the attributes, export the data to a text file. (When data is not recorded in the running HMI, xExpress is empty during data recording)

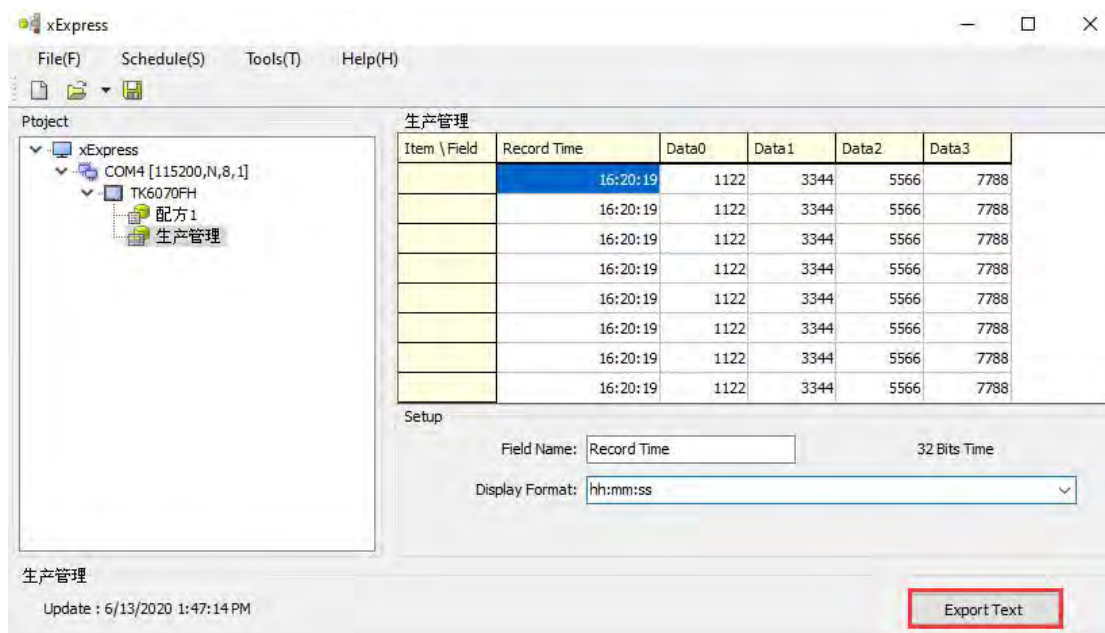

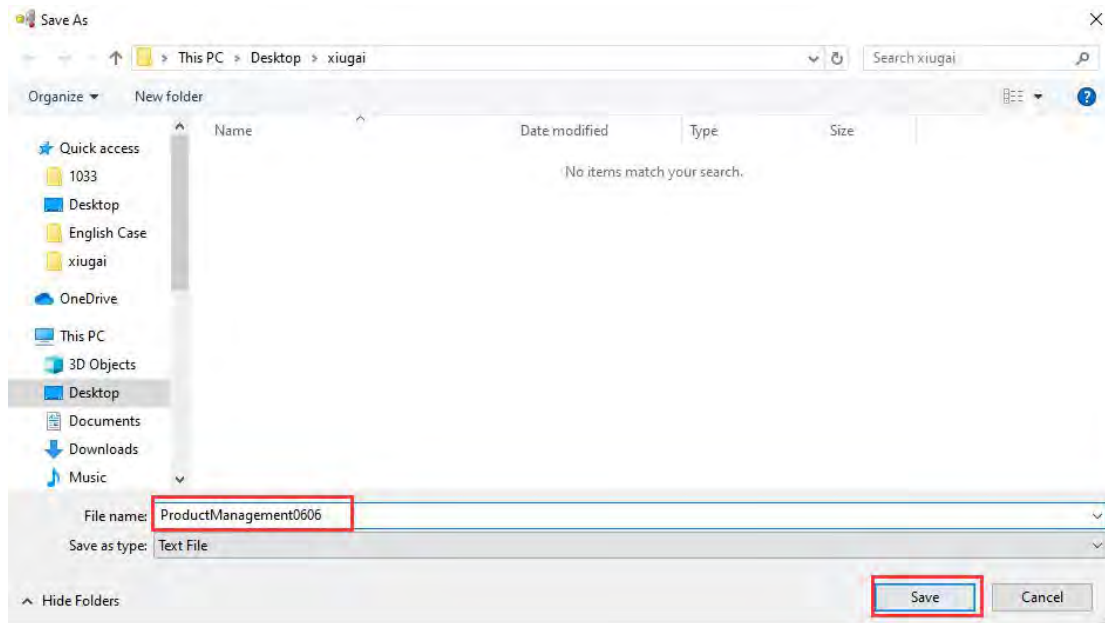

### Step 8

Use the Microsoft Excel software to open the text file saved in step 7 for data analysis and reporting

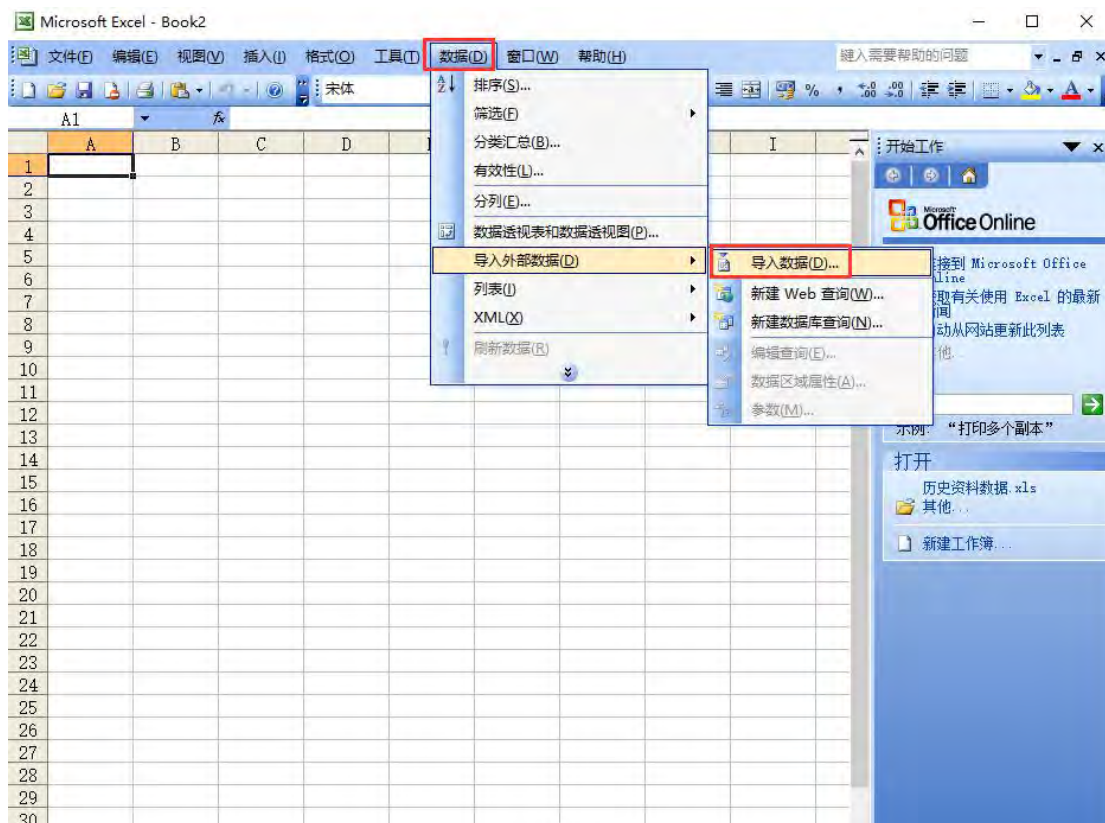



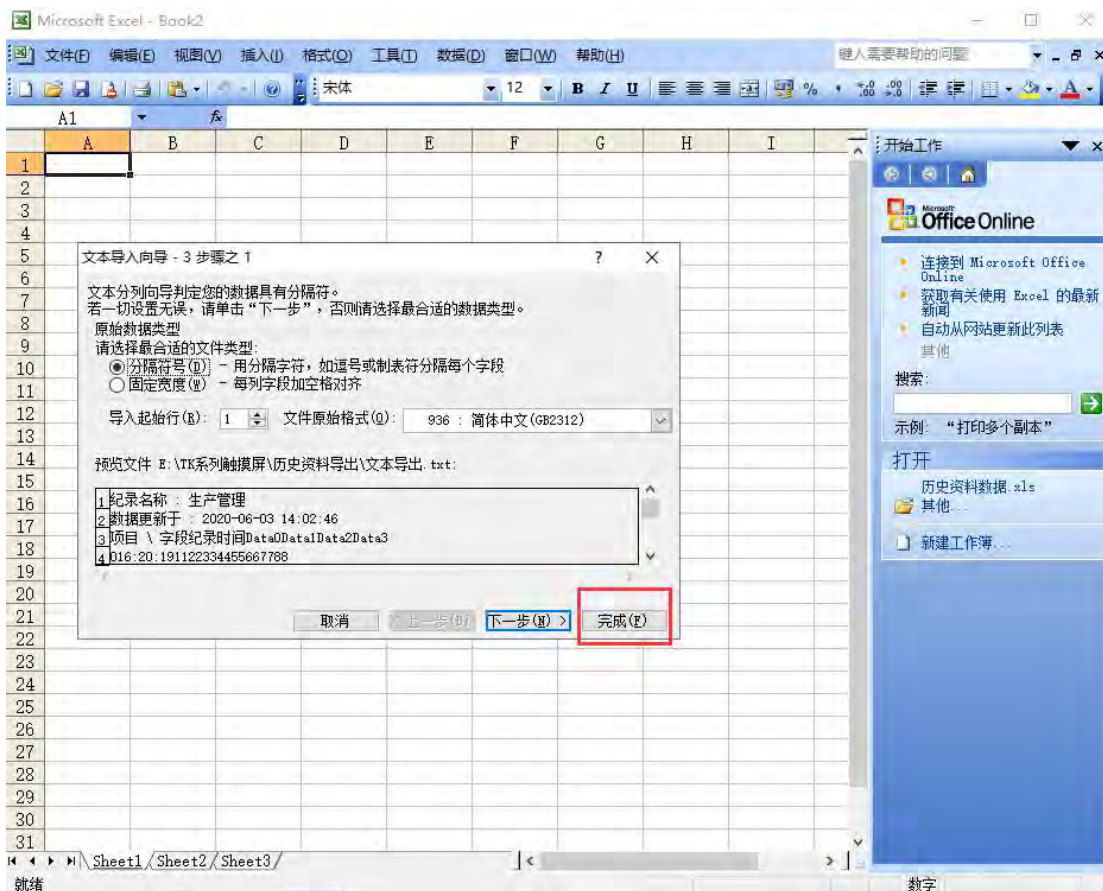
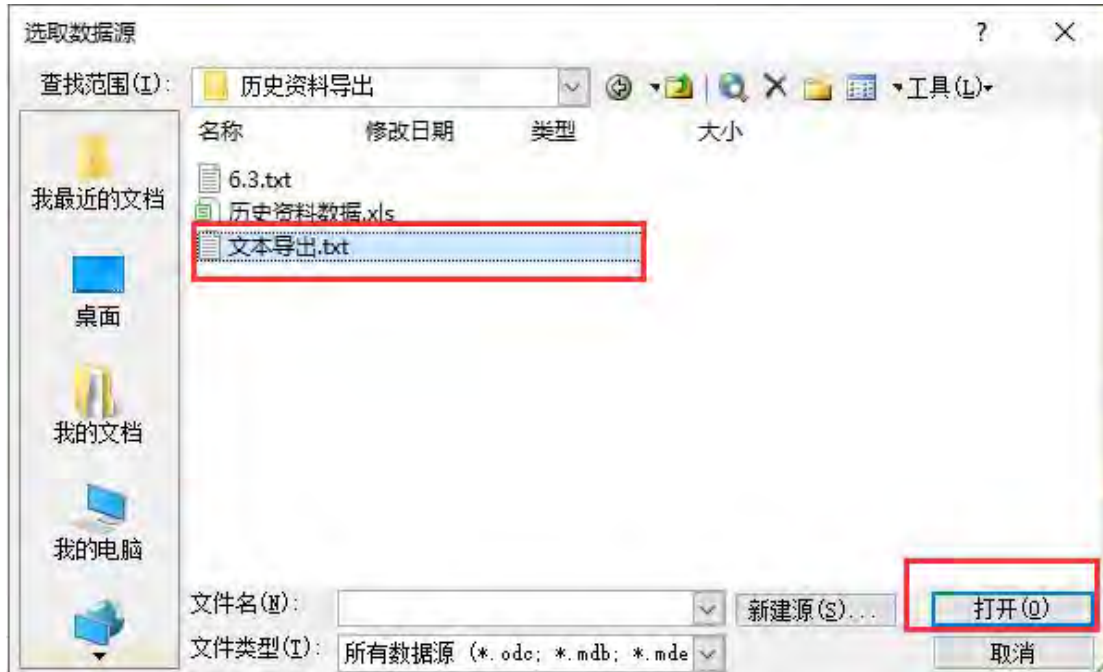



Microsoft Excel - Book2

文件(F) 编辑(E) 视图(V) 插入(I) 格式(O) 工具(T) 数据(D) 窗口(W) 帮助(H)

未体

	A	B	C	D	E	F	G	H	I	J	K	L	M
1	纪录名称：生产管理												
2	数据更新于：2020-06-03 14:02:46												
3	项目 \ 字段	纪录时间	Data0	Data1	Data2	Data3							
4	0	16:20:19	1122	3344	5566	7788							
5	1	16:20:19	1122	3344	5566	7788							
6	2	16:20:19	1122	3344	5566	7788							
7	3	16:20:19	1122	3344	5566	7788							
8	4	16:20:19	1122	3344	5566	7788							
9	5	16:20:19	1122	3344	5566	7788							
10	6	16:20:19	1122	3344	5566	7788							
11	7	16:20:19	1122	3344	5566	7788							
12	8	16:20:19	1122	3344	5566	7788							
13	9	16:20:19	1122	3344	5566	7788							
14	10	16:20:19	1122	3344	5566	7788							
15	11	16:20:19	1122	3344	5566	7788							
16	12	16:20:19	1122	3344	5566	7788							
17	13	16:20:19	1122	3344	5566	7788							
18	14	16:20:19	1122	3344	5566	7788							
19	15	16:20:19	1122	3344	5566	7788							
20	16	16:20:19	1122	3344	5566	7788							
21	17	16:20:19	1122	3344	5566	7788							
22	18	16:20:19	1122	3344	5566	7788							
23	19	16:20:19	1122	3344	5566	7788							
24	20	16:20:19	1122	3344	5566	7788							
25	21	16:20:19	1122	3344	5566	7788							
26	22	16:20:19	1122	3344	5566	7788							
27	23	16:20:19	1122	3344	5566	7788							
28	24	16:20:19	1122	3344	5566	7788							
29	25	16:20:19	1122	3344	5566	7788							
30	26	16:20:19	1122	3344	5566	7788							
31	27	16:20:19	1122	3344	5566	7788							
32	28	16:20:19	1122	3344	5566	7788							

## Appendix 9 HMI modbus RTU Communication

### Instruction

#### Function codes supported by HMI as modbus host

Function No. 01: Read the coil status and get the current status of a group of logic coils (ON/OFF)

Function No. 03: Read holding registers and get the current binary value in one or more holding registers

Function 04: Read the input register to obtain the current binary value in one or more input registers

Function No. 05: Force a single coil, force a logic coil on and off state (write bit)

Function No. 06: Load specific binary values into a holding register (write register)

Function No. 15: Forcibly set multiple coils, force a string of continuous logic coils on and off (write multiple bits)

No. 16 function: preset multiple registers, load specific binary values into a series of continuous holding registers (write multiple registers)

#### 1. Make the setting of the master with only one slave

1. 1. Communication parameter setting, use 485 communication to select COM2 to add communication protocol.

[Project] → [Communication] → [Add Protocol], as shown below

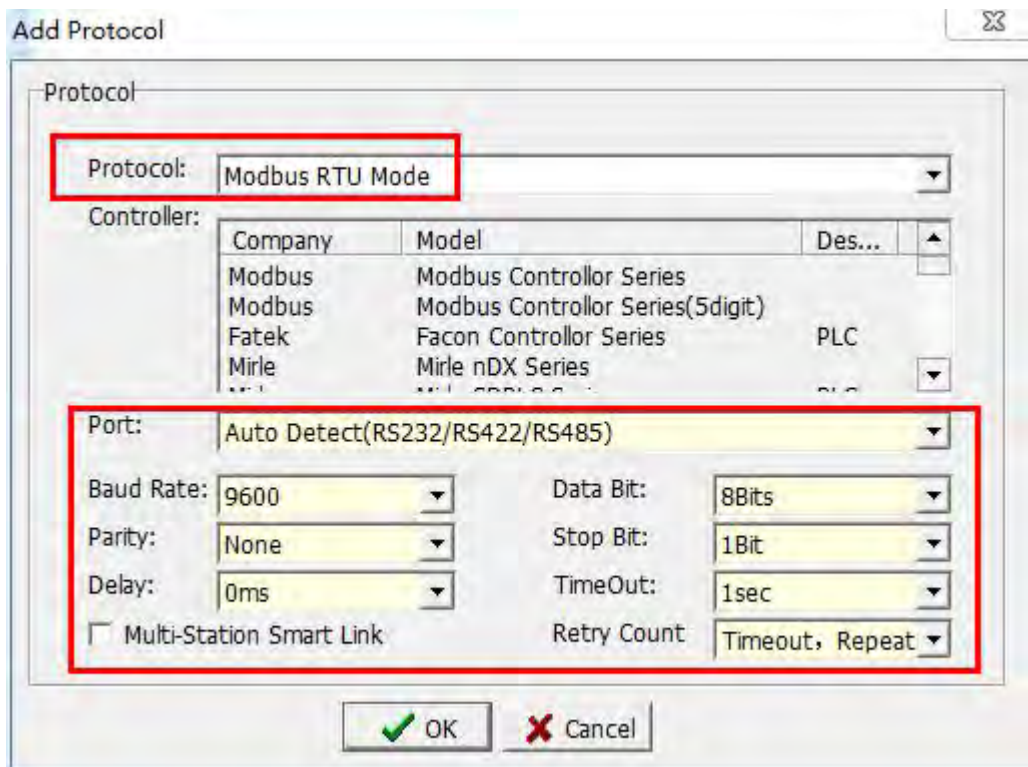
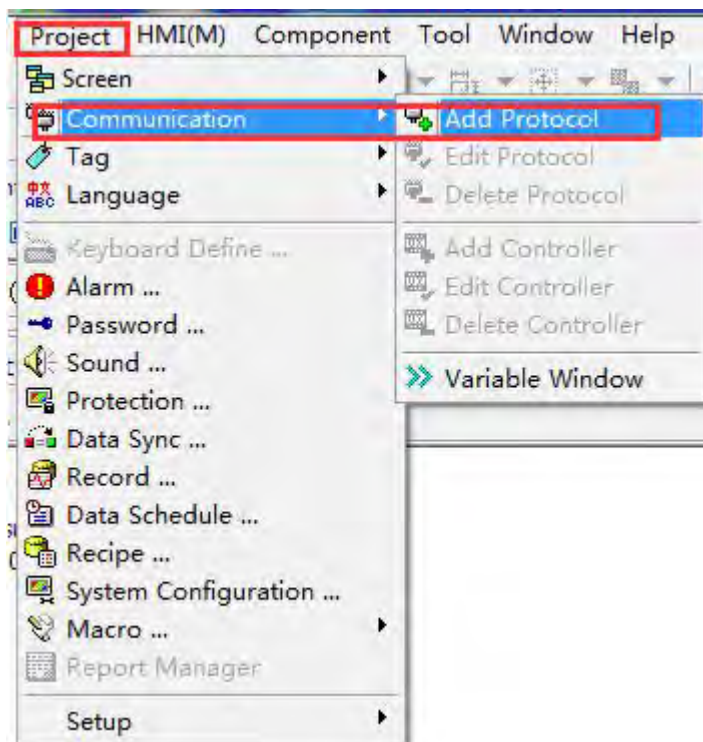

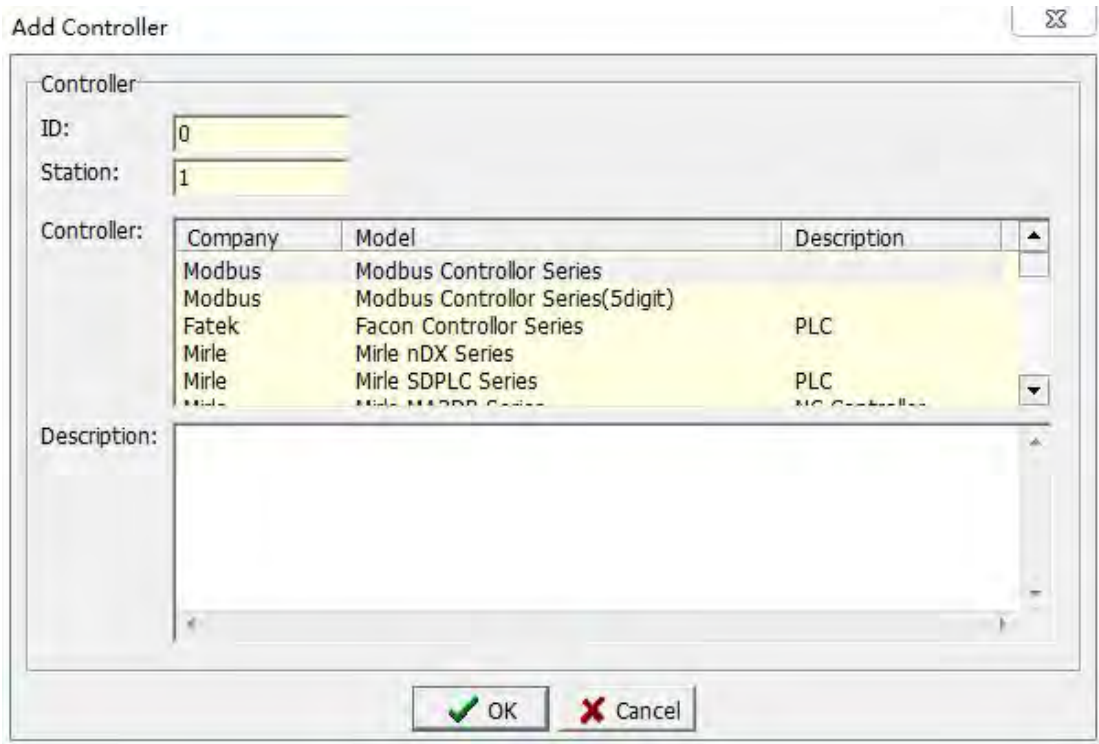

ID: ID number of the controller. (Unique, not repeatable)

Station: the station number of the controller, that is, the slave station number to be read/written. (The station numbers of com1 and com2 can be repeated)

The station number (HMI station number) in the display unit setting is the ID (PLC ID) corresponding to the connected controller, and the ID (HMI ID) set in the display unit is the corresponding Several controllers. For the setting of the station number, COM1 and COM2 of the display unit are independent, so COM1 and COM2 can be set separately to connect the controller with the same station number, but for the setting of ID, each HMI cannot be repeated. Because the ID describes the controller which is the first controller connected to the display unit, as shown in the figure below.

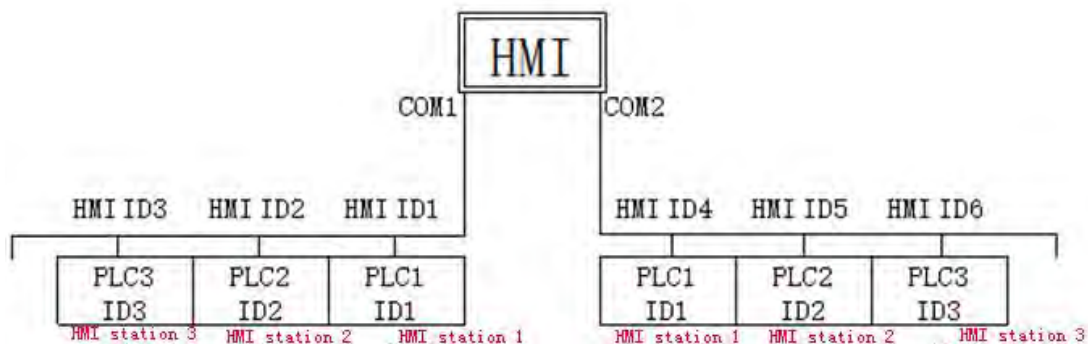

1.2. After the addition is successful, the corresponding communication protocol will appear in the selected communication:



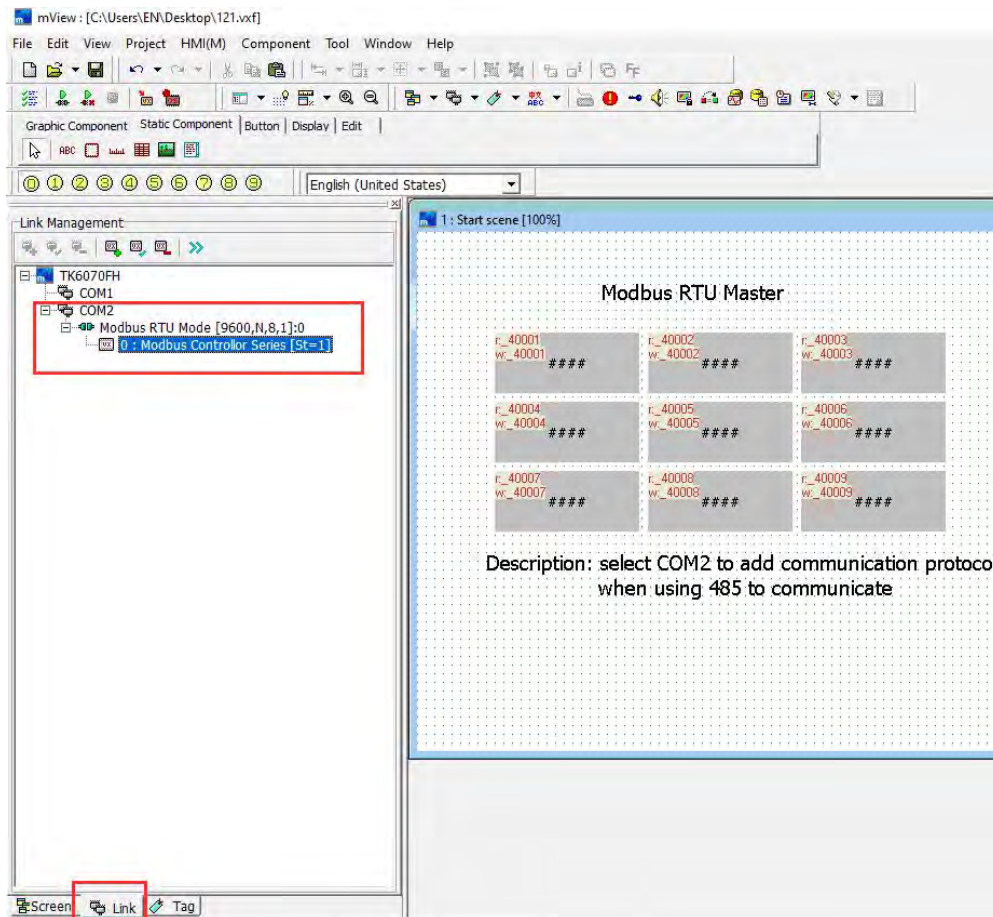

### 1.3. Available variables are as follows

Controller: the device that communicates with the HMI; number: directly enter the address of the variable.

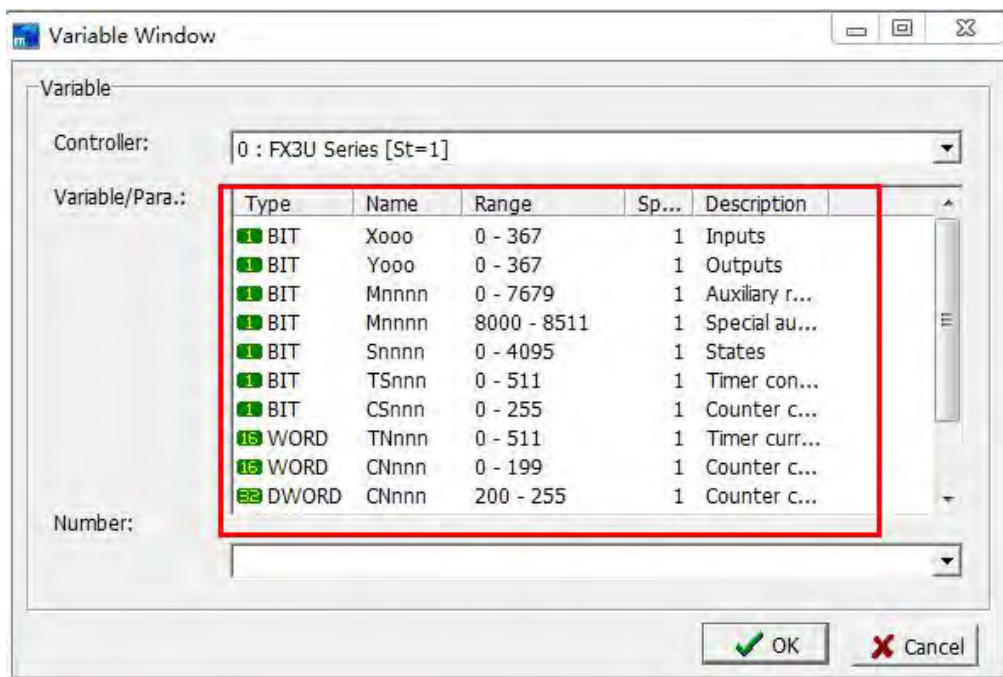



1.4. Place the corresponding variable on the HMI screen and use 485 to connect the modbus communication device, that is, you can read/write the data of the corresponding variable address, as shown in the following figure:



## 2. Set up the master with multiple slaves

2.1. Communication parameter setting, use 485 communication to select COM2 to add communication protocol.

If you need to connect multiple slaves, you need to add multiple controllers. Each controller corresponds to a device that reads/writes a different slave station number. [Project] → [Communication] → [Add Controller], as shown below Shown

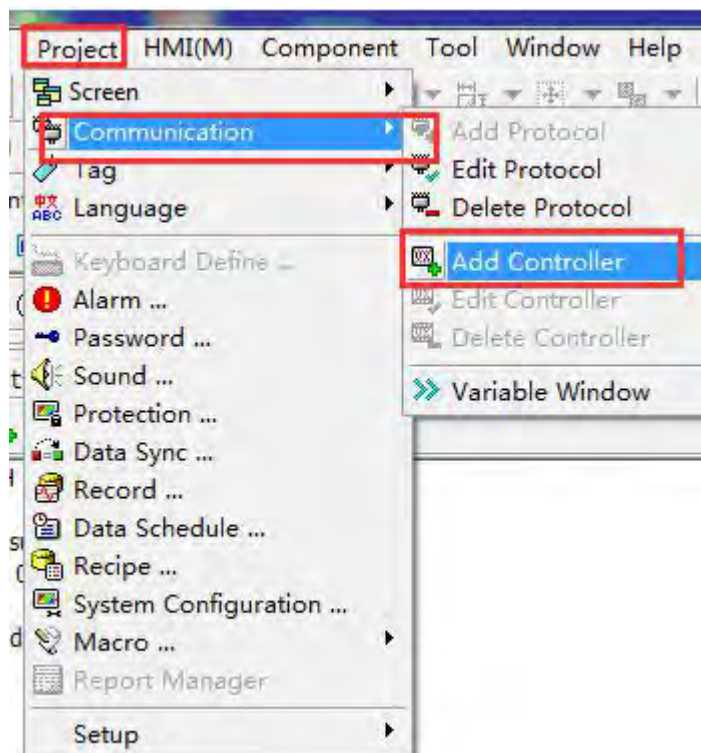

Or directly select the communication protocol, right click mouse → [Add controller]

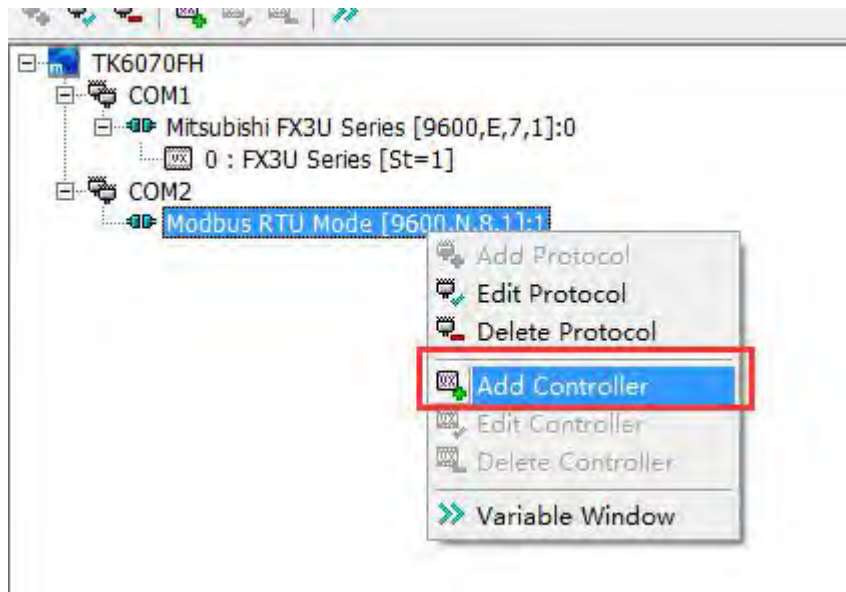

Note that when connecting multiple products for communication, you need to tick [Multi-Station Smart Link] and select [Timeout, Non- retransmission]

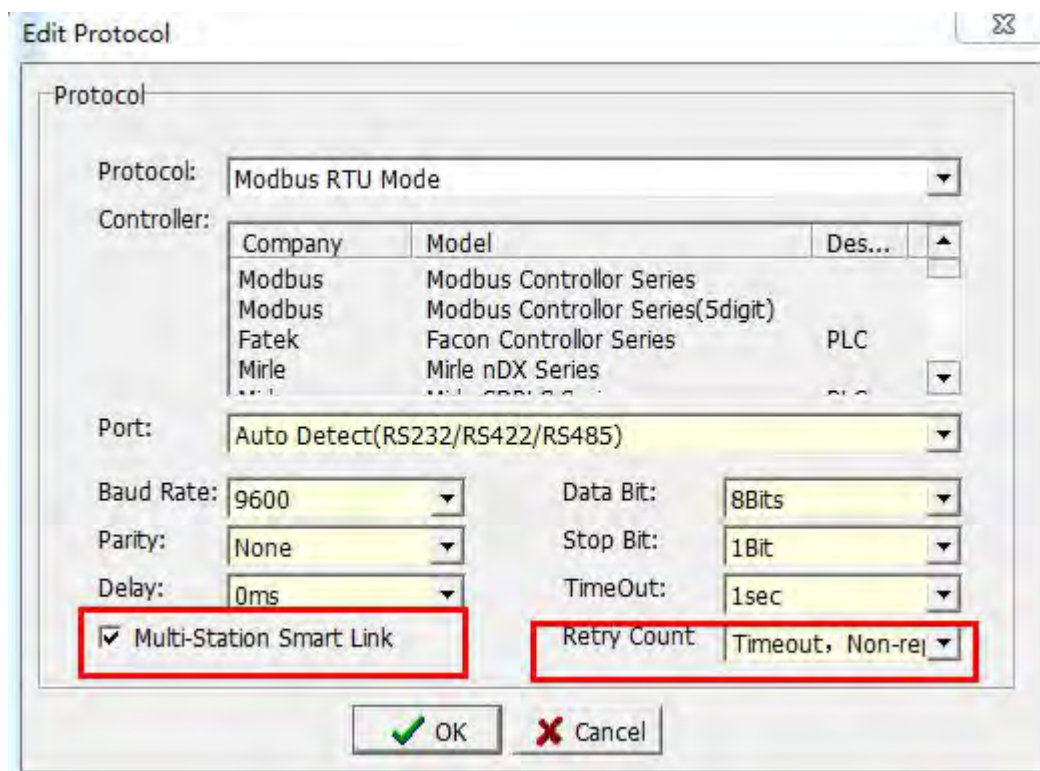

2.2. After adding 3 controllers successfully, it is as follows:

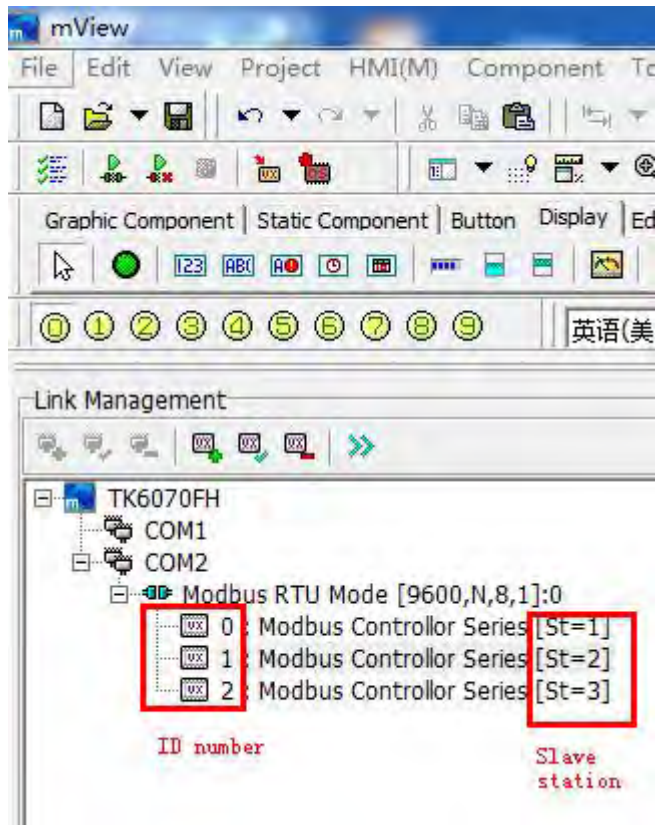

2.3. Add the variable requesting to read/write the slave station number in the order of ①②③④ as follows, ②Select the slave station corresponding to the variable address

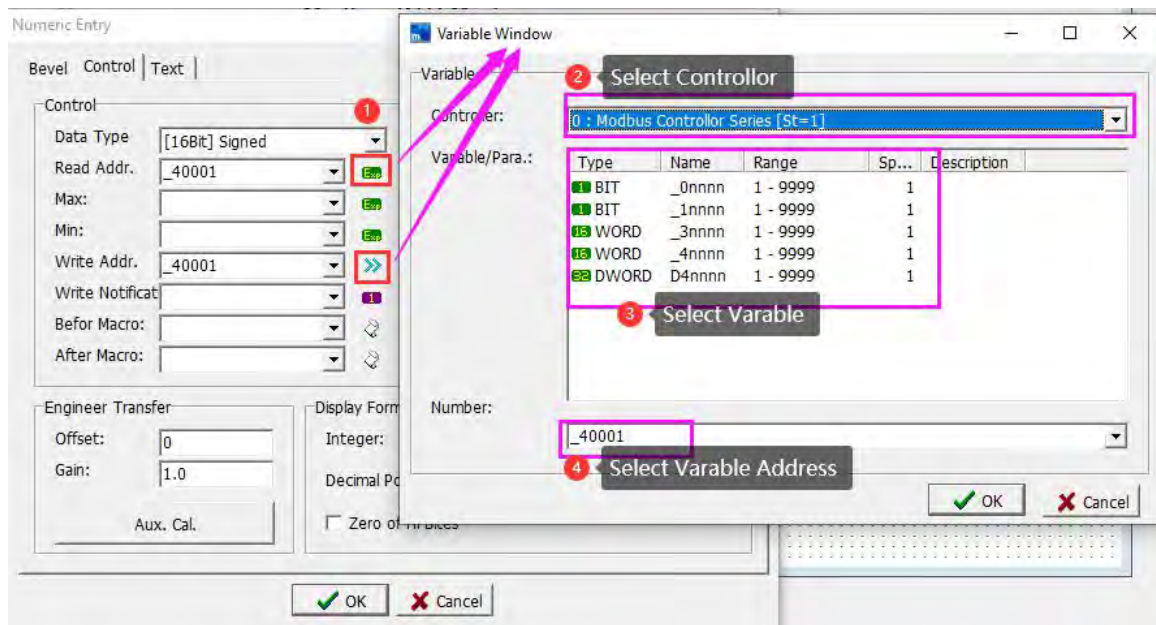

For example, slave 2 variable address:



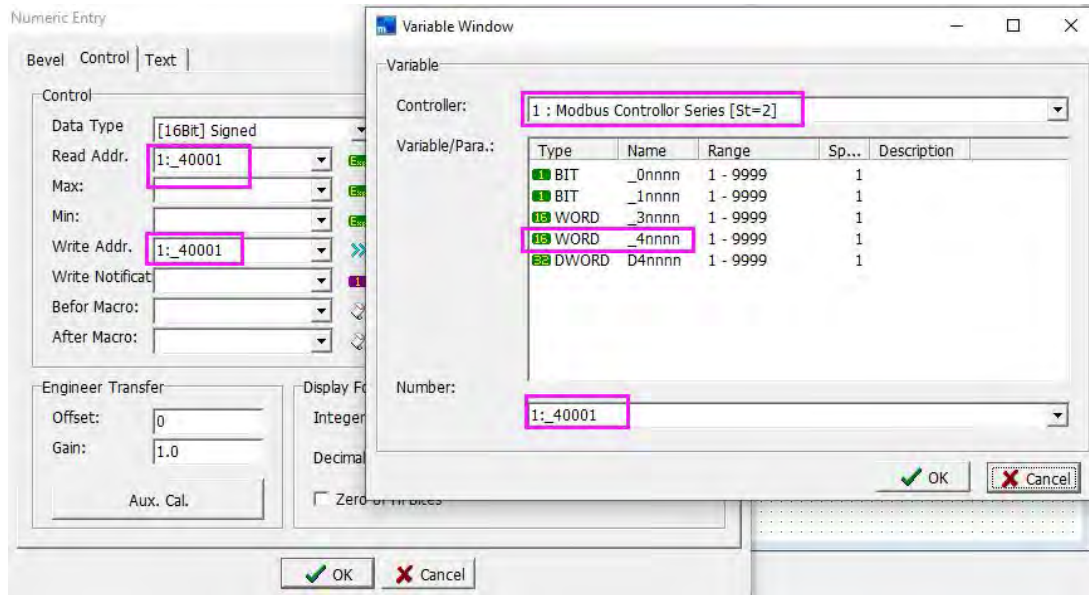

Slave 3 variable address:

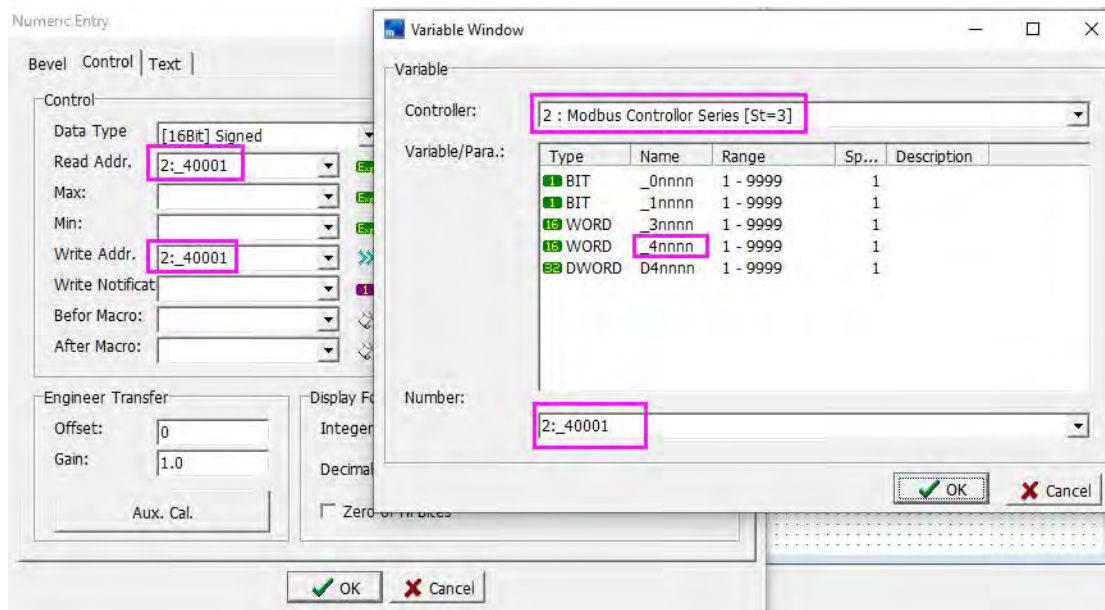

2.4. Place the corresponding variable on the HMI screen and use 485 to connect the modbus communication device, that is, you can read/write the data of the corresponding variable address, as shown in the following figure:

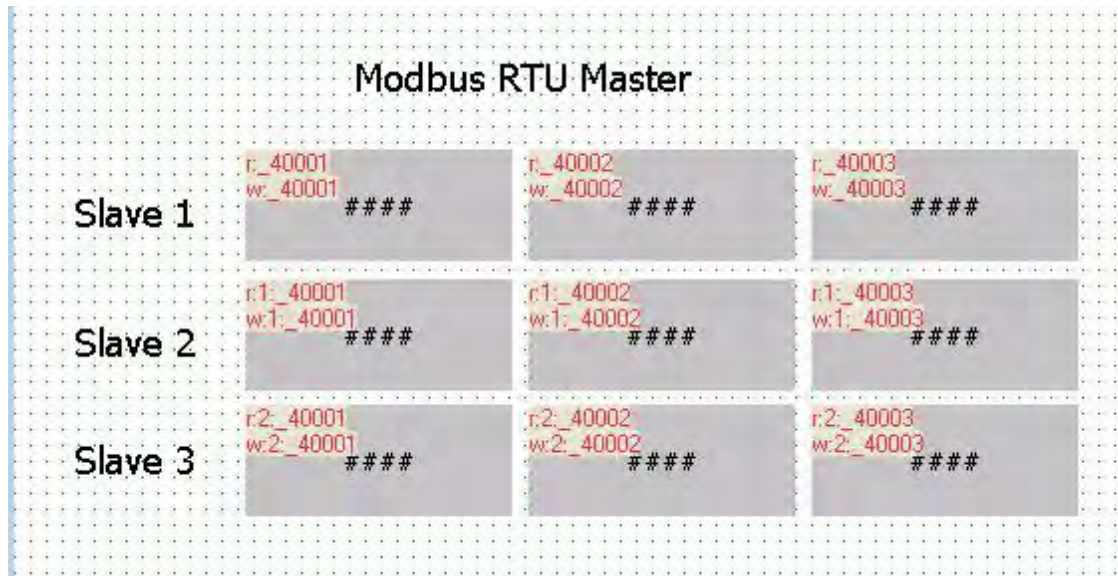

### 3. Setting of HMI as slave

3.1 Note: Without adding any protocol and device, the HMI will act as MODBUS RTU slave.

How to set the station number of the slave station:

- ① Project>Setup>ID.
- ② Use N65128 to set directly on HMI.

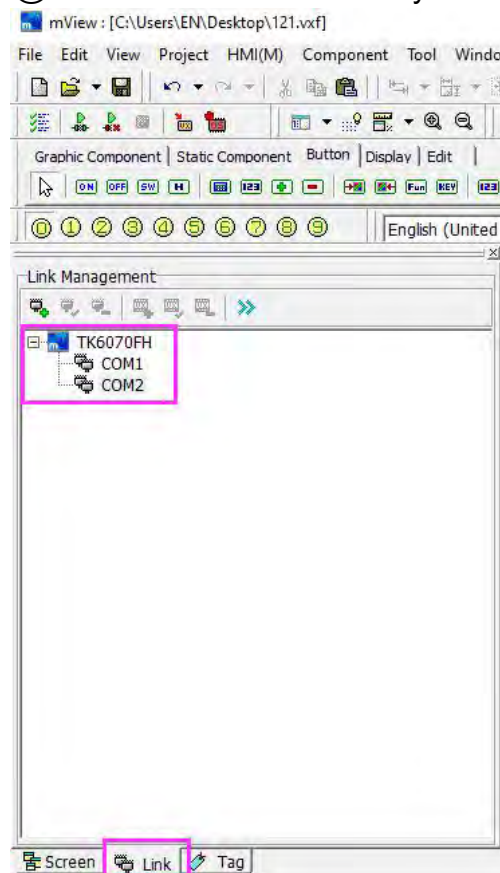



Currently only supports MODBUS RTU. Two methods for setting communication parameters on HMI:

- ① Draw a diagonal line from the upper left corner of the HMI to enter the system settings.
- ② Use the jump screen button to switch the screen to [65005: System setting screen]

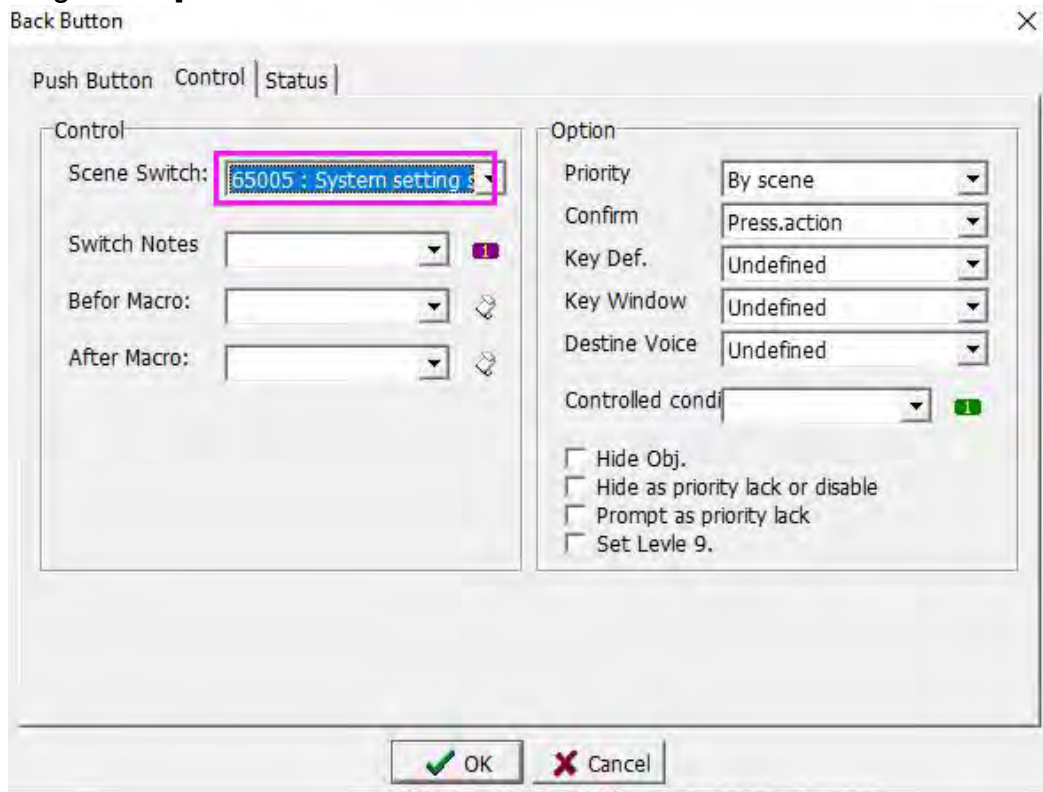

### 3.2 The variables available when HMI is used as a slave are as follows

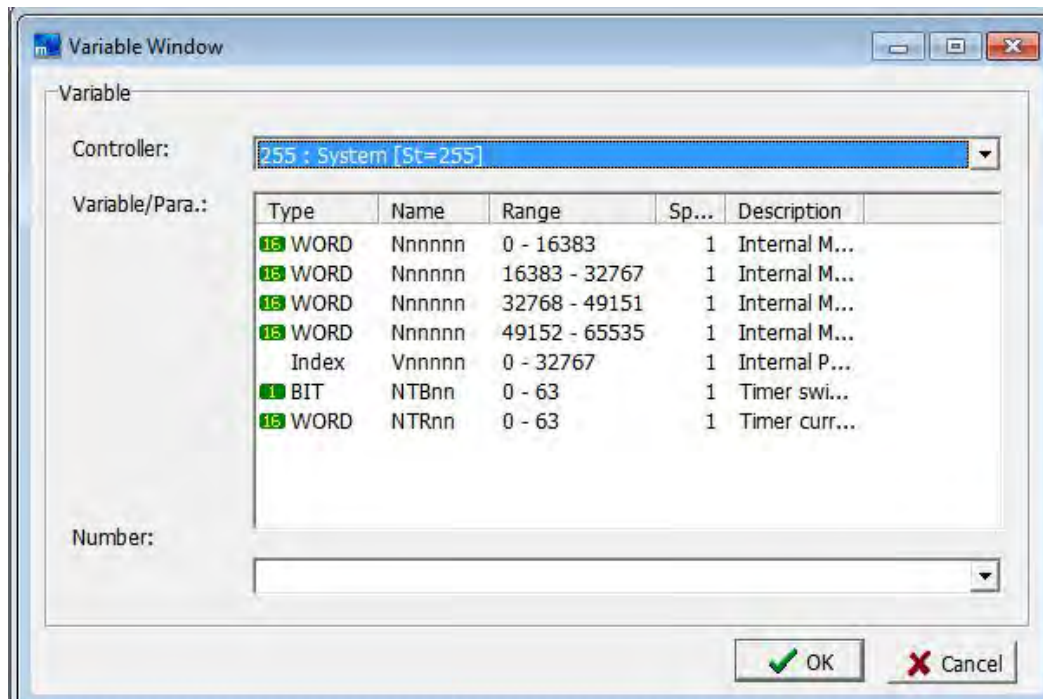

**The corresponding address number of HMI register in modbus communication:**

Modbus NO.	HMI internal variables
400000~465535	N0~N65535

**The corresponding address number of HMI bit component in modbus communication:**

In HMI, an internal variable N has 16 bits, where N0.0 corresponds to 0X0000, N0.1 corresponds to 0X0001, and so on...

## Appendix 10 Instructions of Coolmay TK series HMI communicating with other band PLC

### Hardware specifications:

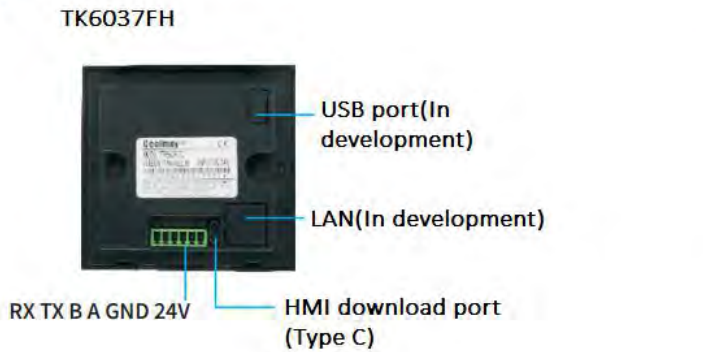

Pin number	Description
RS232 COM port definition	
RXD	Accept
TXD	Send
GND	Ground/DC24V-
RS485 COM port definition	
A	485+
B	485-
DC24V Power Supply	
24V	DC24V+
GND	Ground/DC24V-

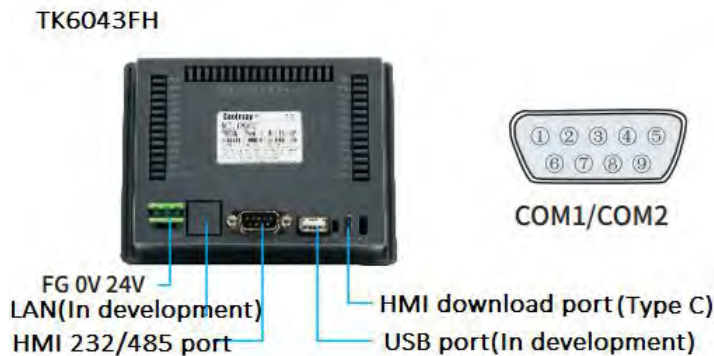

Pin No.	Signal	Description
RS232COM port definition		
2	RXD	Accept
3	TXD	Send
5	GND	Ground
RS485 COM port definition		
1	A	485+
6	B	485-

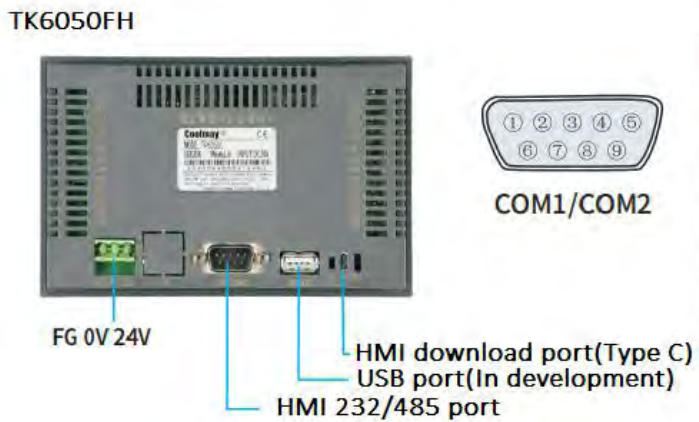

Pin No.	Signal	Description
RS232 COM port definition		
2	RXD	Accept
3	TXD	Send
5	GND	Ground
RS485 COM port definition		
1	A	485+
6	B	485-

TK6070FH/HD

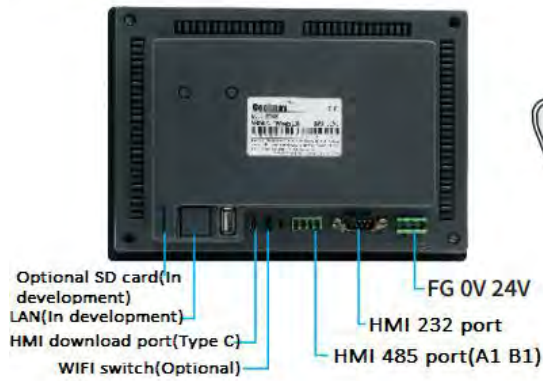

Pin No.	Signal	Description
RS232 COM port definition		
2	RXD	Accept
3	TXD	Send
5	GND	Ground
RS485 COM port definition		
Interface	A1	485+
	B1	485-

TK6070KFH

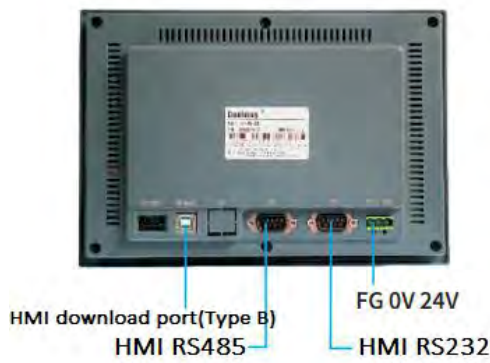

Pin No.	Signal	Description
COM2 RS232 COM port definition		
2	RXD	Accept
3	TXD	Send
5	GND	Ground
COM1 RS485 COM port definition		
1	A	485+
6	B	485-

TK6100FH

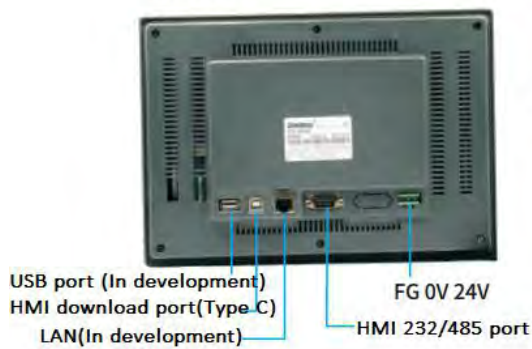

Pin No.	Signal	Description
RS232 COM port definition		
2	RXD	Accept
3	TXD	Send
5	GND	Ground
RS485 COM port definition		
1	A	485+
6	B	485-

1.Coolmay CX series

Method 1: Use RS232 connection

➤TK software setting

Parameter item	Recommended settings
Protocol	CoolMay PLC(3U/3G)/FX3U
Communication port type	RS232
Communication rate	9600



Synchronization check	Even parity
Number of data	7 digits
Stop digits	1 digit

Add Protocol

Protocol: CoolMay PLC(3U/3G)/FX3U

Controller:

Company	Model	Des...
CoolMay	CoolMay 3U Series	PLC

Port: Auto Detect(RS232/RS422/RS485)

Baud Rate: 9600 Data Bit: 7Bits

Parity: Even Stop Bit: 1Bit

Delay: 0ms TimeOut: 1sec

Multi-Station Smart Link Retry Count: Timeout, Repeat

OK Cancel

### ➤ Operable variable

Variable Window

Variable

Controller: 0 : CoolMay 3U Series [St=1]

Variable/Para.:

Type	Name	Range	Sp...	Description
1 BIT	Xooo	0 - 367	1	Inputs
1 BIT	Yooo	0 - 367	1	Outputs
1 BIT	Mnnnn	0 - 7679	1	Auxiliary r...
1 BIT	Mnnnn	8000 - 8511	1	Special au...
1 BIT	Snnnn	0 - 4095	1	States
1 BIT	TSnnn	0 - 511	1	Timer con...
1 BIT	CSnnn	0 - 255	1	Counter c...
16 WORD	TNnnn	0 - 511	1	Timer curr...
16 WORD	CNnnn	0 - 199	1	Counter c...
32 DWORD	CNnnn	200 - 255	1	Counter c...

Number:

OK Cancel



➤ TK(COM1)-CX series PLC communication line connection diagram (use CX2N series download line)

TK series HMI side with 9-hole D-shaped female socket

Coolmay PLC side with 8-pin male socket

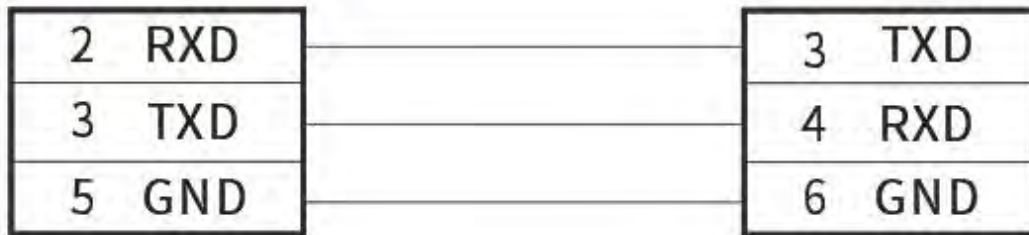

Method 2: Use RS485 connection

➤TK software setting

Parameter item	Recommended settings
Protocol	CoolMay PLC(3U/3G)/FX3U
Communication port type	RS485
Communication rate	9600
Synchronization check	Even parity
Number of data	7 digits
Stop digits	1 digit

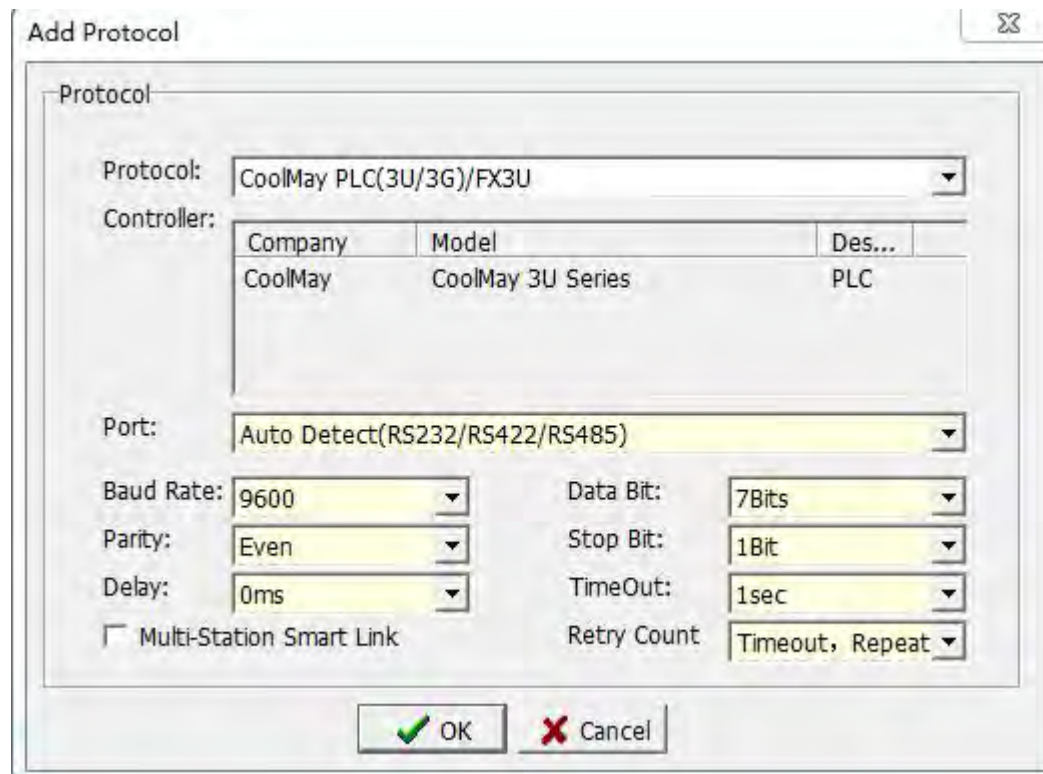

### ➤ Operable variable

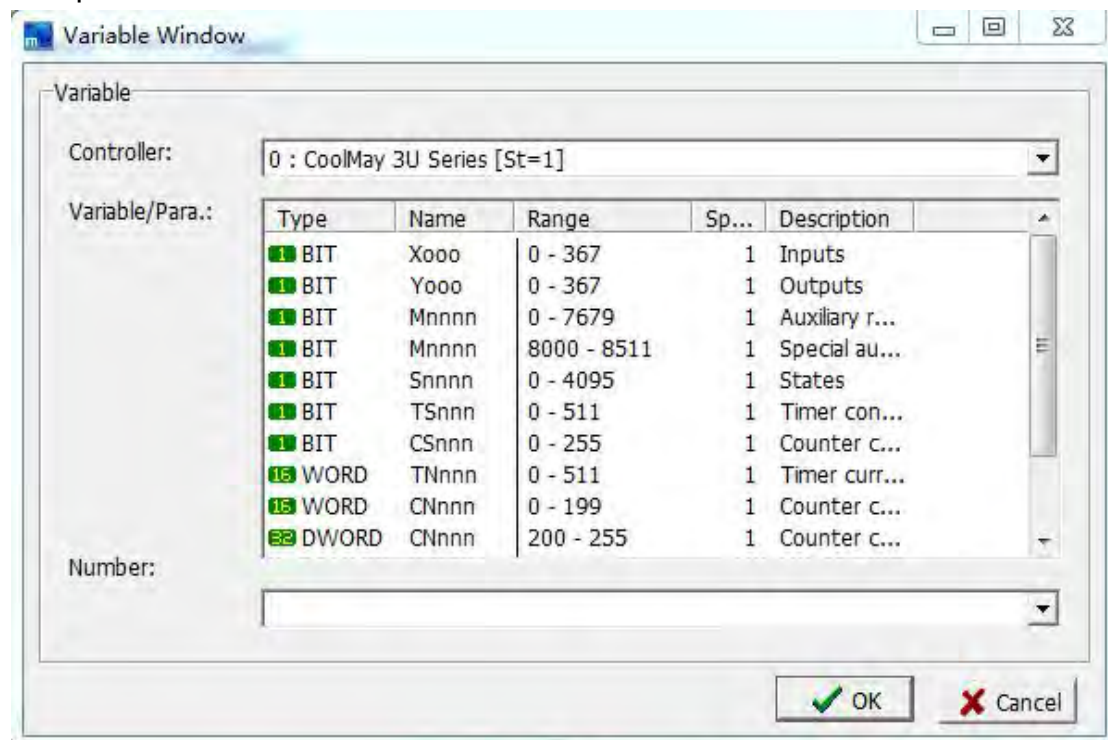

### ➤TK(COM1)-CX series PLC communication line connection diagram

TK series HMI side with 9-hole D-shaped female socket

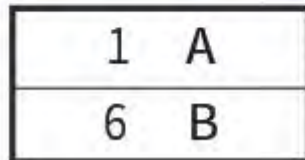

Coolmay PLC side connected with 5pin terminal

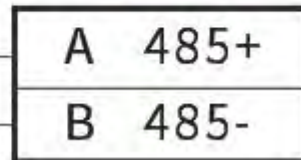

## 2. AD4401 (Japan AIAND weighing controller)

➤ TK software settings

Parameter item	Recommended settings
Protocol	AD-4401 Series
Communication port type	RS232
Communication rate	9600
Synchronization check	Even parity
Number of data	7 digits
Stop digits	1 digit

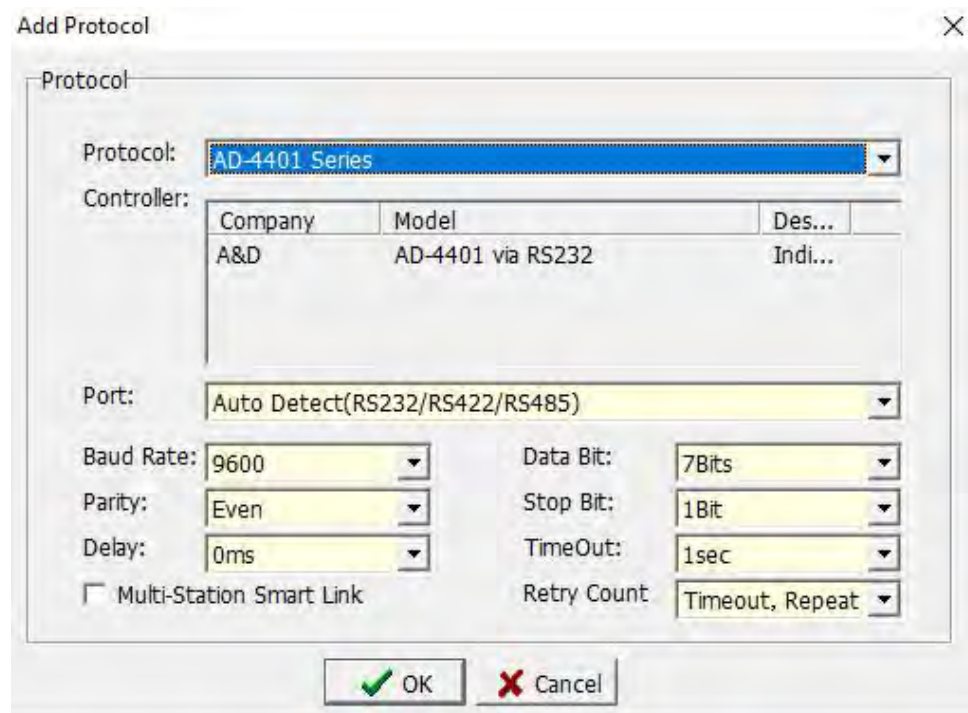

## ➤ Variable

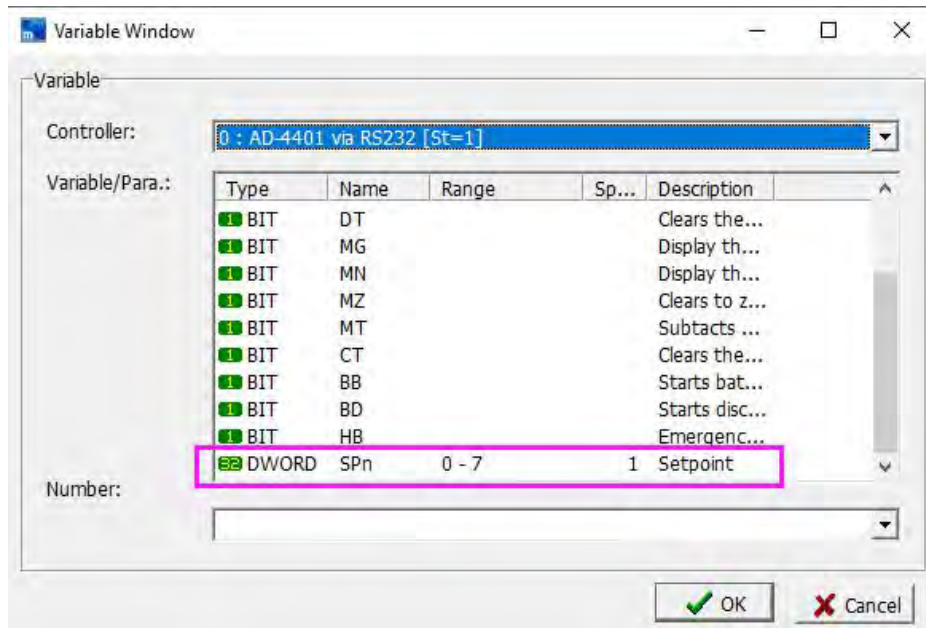

## ➤ Diagram of TK(COM1)-AD4401 communication cable

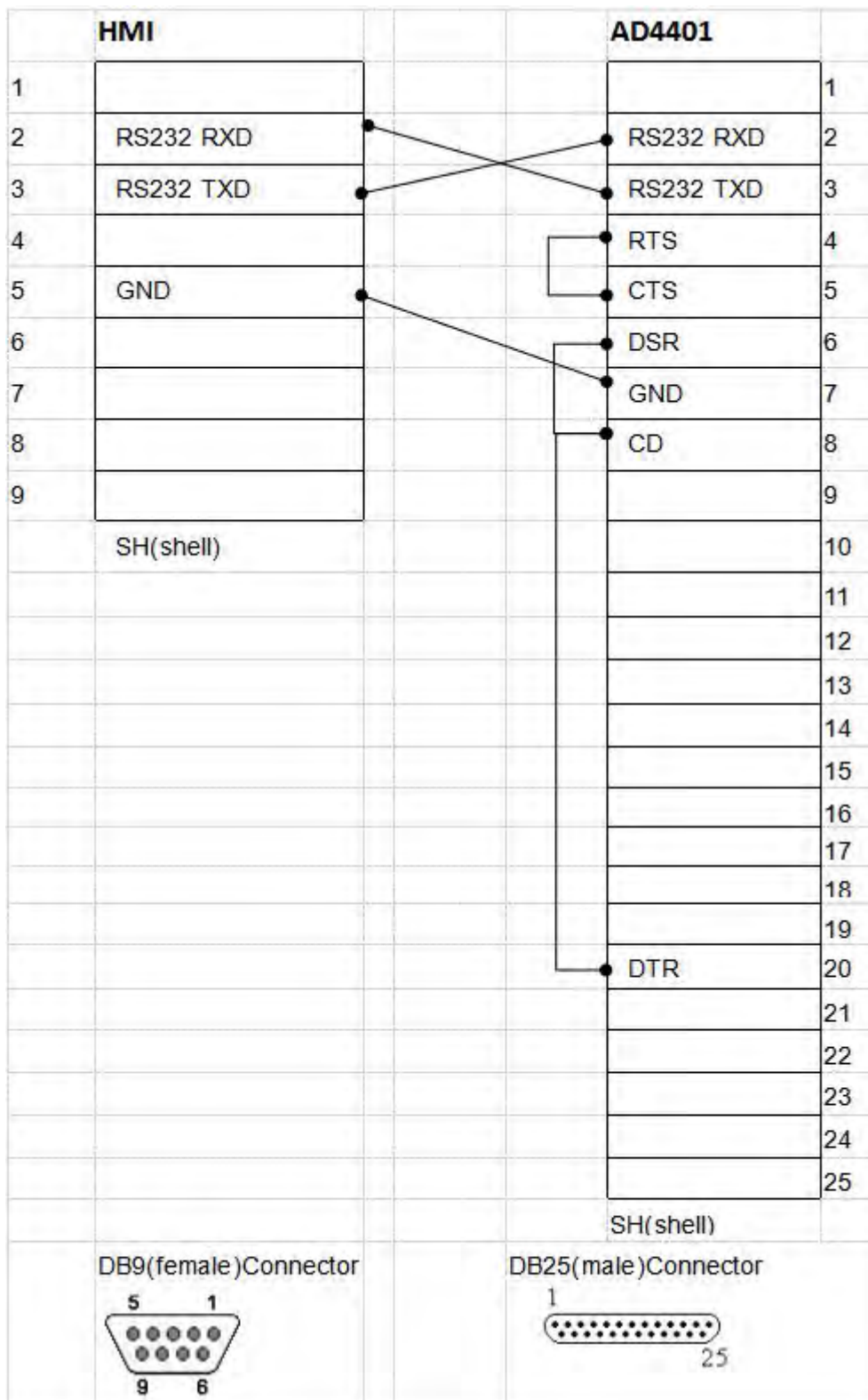

### 3. Fuji MICREX-SX Series (Fuji)

➤TK software settings

Parameter item	Recommended settings
Protocol	Fuji MICREX-SX Series



Communication port type	RS232
Communication rate	38400
Synchronization check	Even parity
Number of data	8 digits
Stop digits	1 digit

Protocol

Protocol: Fuji MICREX-SX Series

Controller:

Company	Model	Des...
Fuji electric	MICREX-SX Series	PLC

Port: Auto Detect(RS232/RS422/RS485)

Baud Rate: 38400 Data Bit: 8Bits

Parity: Even Stop Bit: 1Bit

Delay: 0ms TimeOut: 1sec

Multi-Station Smart Link Retry Count: Timeout, Repeat

### ➤Manipulable variable

Variable Window

Variable

Controller: 0 : MICREX-SX Series [St=0]

Variable/Para.:

Type	Name	Range	Sp...	Description
WORD	IW.xxxx	0 - 7FFF	1	
WORD	QW.xxxx	0 - 7FFF	1	
WORD	MW1.x...	0 - 7FFF	1	
WORD	MW3.x...	0 - 7FFF	1	
WORD	MW10....	0 - 7FFF	1	

Number:

➤TK-Fuji MICREX-SX Series Communication cable connection diagram (using 232 crossover cable)

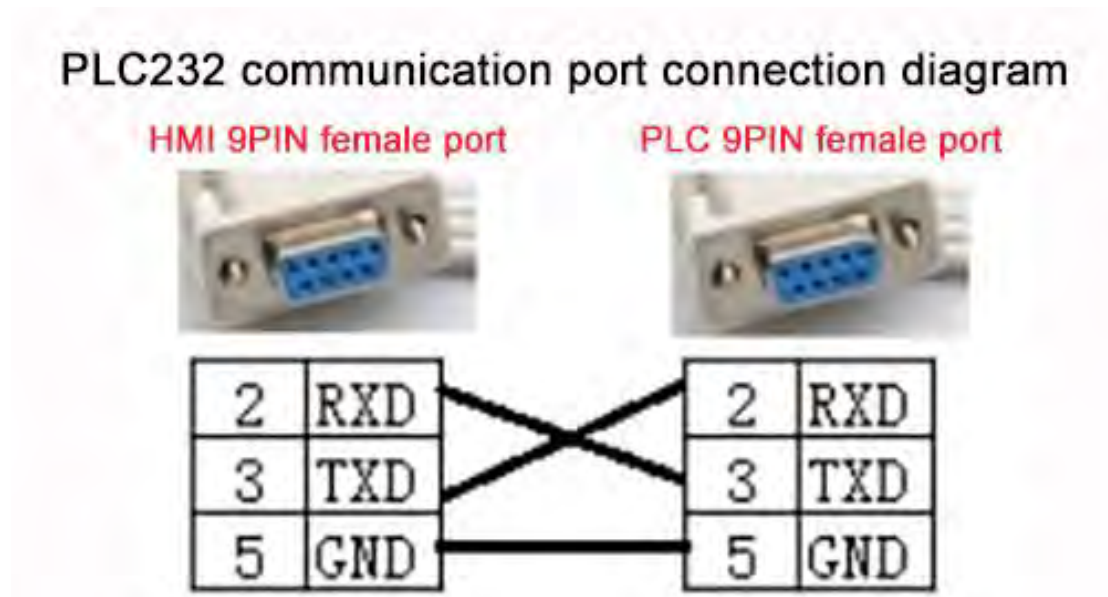

#### 4.Mitsubishi FX series

➤TK software settings

Parameter item	Recommended settings
Protocol	Mitsubishi Fx Series
Communication	RS232
Communication	9600
Synchronization	Even parity
Number of data	7 digits
Stop digits	1 digit

Protocol

Protocol: Mitsubishi FX Series

Controller:

Company	Model	Des...
Mitsubishi	FX Series	PLC
Mitsubishi	FX1S Series	PLC

Port: Auto Detect(RS232/RS422/RS485)

Baud Rate: 9600 Data Bit: 7Bits

Parity: Even Stop Bit: 1Bit

Delay: 0ms TimeOut: 1sec

Multi-Station Smart Link Retry Count: Timeout, Repeat

OK Cancel

### ► Manipulable variable

Variable

Controller: 0 : FX Series [St=1]

Variable/Para.:

Type	Name	Range	Sp...	Description
1 BIT	Xooo	0 - 177	1	
1 BIT	Yooo	0 - 177	1	
1 BIT	Mnnnn	0 - 1023	1	
1 BIT	Mnnnn	8000 - 8255	1	
1 BIT	Snnn	0 - 999	1	
1 BIT	Tnnn	0 - 255	1	
1 BIT	Cnnn	0 - 255	1	
16 WORD	RTnnn	0 - 255	1	
16 WORD	RCnnn	0 - 199	1	
32 DWORD	DRCnnn	200 - 255	1	

Number:

OK Cancel

### ► TK-FX Series Communication line connection diagram (using Mitsubishi programming line, namely SC-11/SC-09)

TK series touch side with 9 holes  
D-shaped female connector



2	RXD
3	TXD
5	GND

FX series PLC side with 8-pin  
male connector



PLC programming port pin definition

PIN number	Signal	Description
1	RXD-	Accept negative
2	RXD+	Accept positive
3	GND	ground
4	TXD-	Send negative
5	+5V	External power supply
6	CCS	Communication direction control line
7	TXD+	Send positive
8	NC	Empty foot

## 5. Keyence KV series

➤TK software settings

Parameter item	Recommended
Protocol	Keyence KV Series
Communication port type	RS232
Communication rate	9600
Synchronization check	Even parity
Number of data	8 digits
Stop digits	1 digit



Protocol

Protocol: Keyence KV Series

Controller:

Company	Model	Des...
Keyence	KV Series	PLC

Port: Auto Detect(RS232/RS422/RS485)

Baud Rate: 9600 Data Bit: 8Bits

Parity: Even Stop Bit: 1Bit

Delay: 0ms TimeOut: 1sec

Multi-Station Smart Link Retry Count: Timeout, Repeat

➤Manipulable variable

Variable

Controller: 0 : KV Series [St=1]

Variable/Para.:

Type	Name	Range	Sp...	Description
1 BIT	_nnn	0 - 415	1	Input Relay
1 BIT	_nnn	500 - 915	1	Output R...
1 BIT	_nnnn	1000 - 6915	1	Internal R...
1 BIT	Rnnnnn	0 - 99915	1	Relay
1 BIT	Bxxxx	0 - 3FFF	1	Link relay
1 BIT	MRnnnnn	0 - 99915	1	Internal a...
1 BIT	LRnnnnn	0 - 99915	1	Latch relay
1 BIT	CRnnnn	0 - 3915	1	Control relay
1 BIT	VBxxxx	0 - 3FFF	1	Virtual relay
16 WORD	DMnnnnn	0 - 65534	1	Data Mem...
16 WORD	TMnnn	0 - 512	1	Temporar...
16 WORD	EMnnnnn	0 - 65534	1	Extended...
16 WORD	FMnnnnn	0 - 32767	1	File register
16 WORD	ZFnnnnn	0 - 99999	1	File register
16 WORD	Wxxxx	0 - 3FFF	1	Link register
16 WORD	TMnnn	0 - 511	1	Temporar...
16 WORD	Znn	1 - 12	1	Index regi...
16 WORD	CMnnnn	0 - 5999	1	Control m...
16 WORD	VMnnnnn	0 - 59999	1	virtual me...
32 DWORD	Tnnnn	0 - 3999	1	Timer
32 DWORD	TCnnnn	0 - 3999	1	Timer (cu...
32 DWORD	TSnnnn	0 - 3999	1	Timer (se...
32 DWORD	Cnnnn	0 - 3999	1	Counter
32 DWORD	CCnnnn	0 - 3999	1	Counter (...
32 DWORD	CSnnnn	0 - 3999	1	Counter (...
32 DWORD	CTHn	0 - 3	1	High-spee...
32 DWORD	CTCn	0 - 3	1	High-spee...

Number:



➤TK-Keyence KV Communication line connection diagram

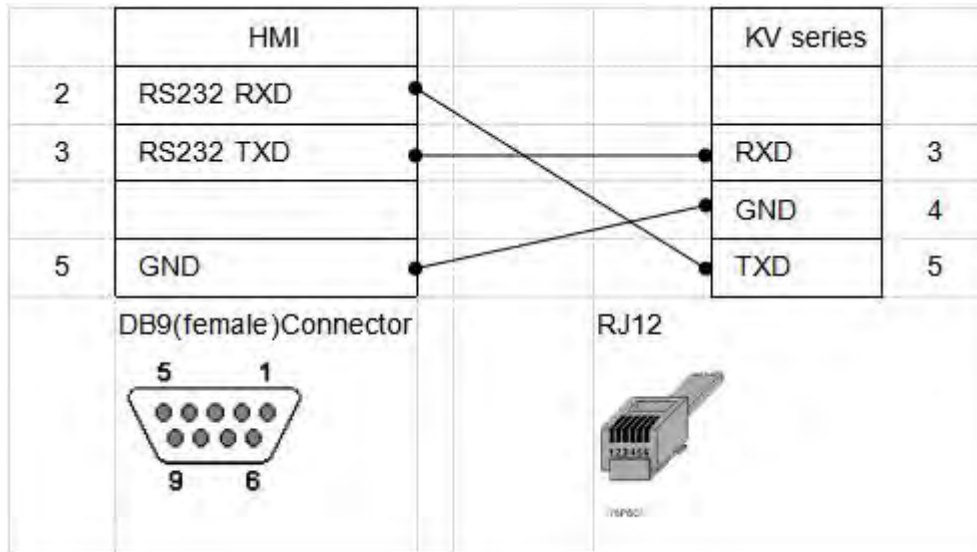

**6.Koyo K sequence series**

➤TK software settings

Parameter item	Recommended
Protocol	Koyo K sequence
Communication port	RS232
Communication rate	9600
Synchronization check	Odd parity
Number of data	8 digits
Stop digits	1 digit

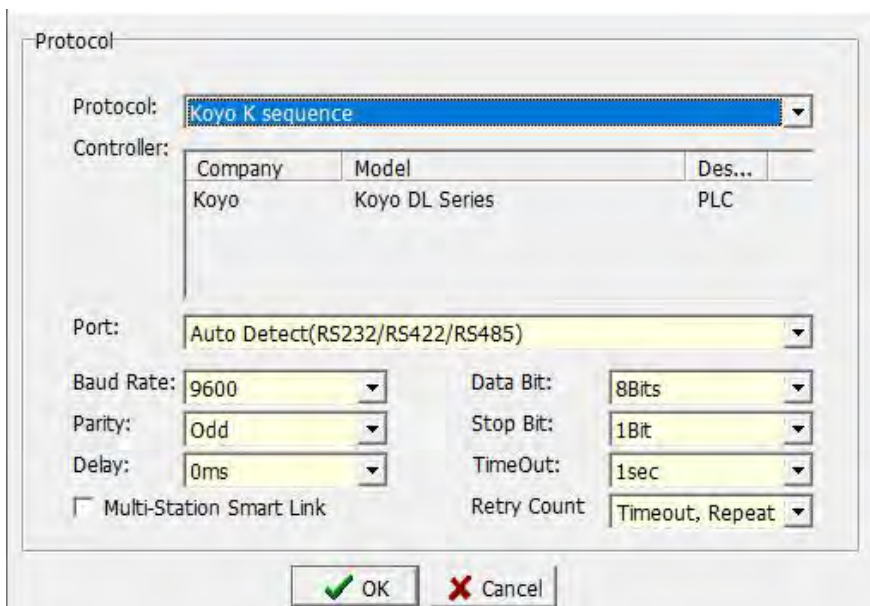

➤Manipulable variable

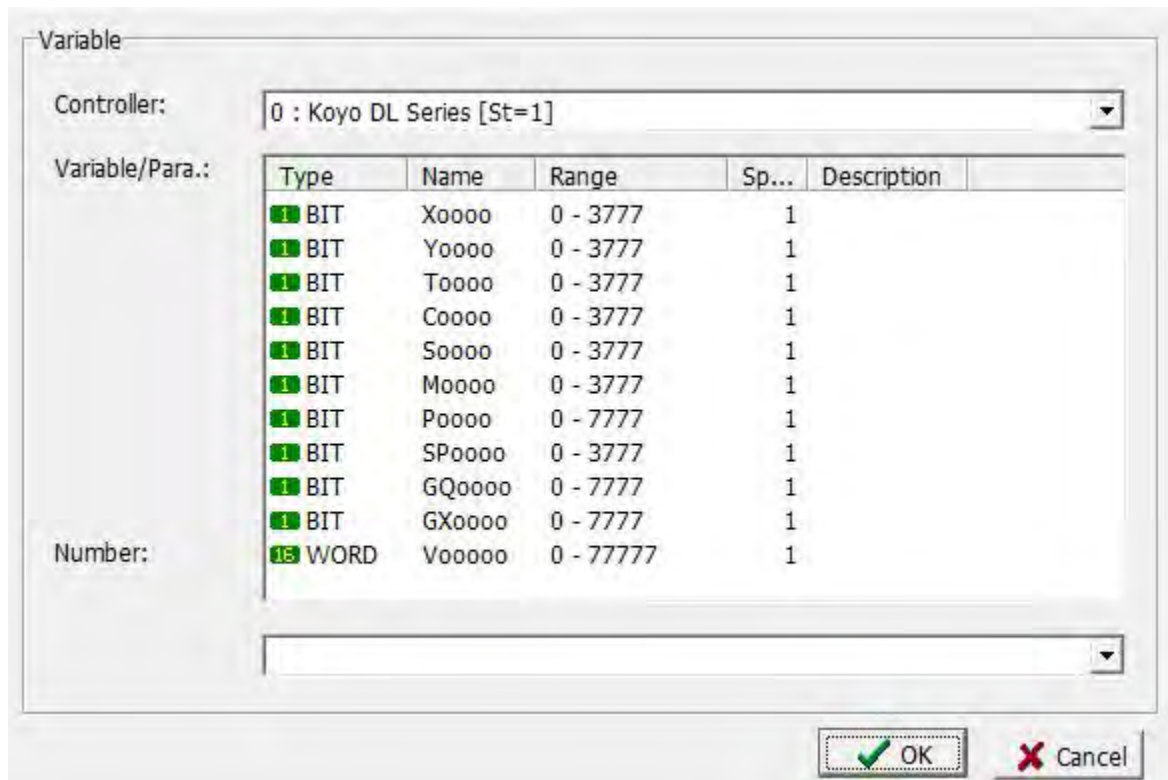

➤TK-Koyo K sequence Communication line connection diagram

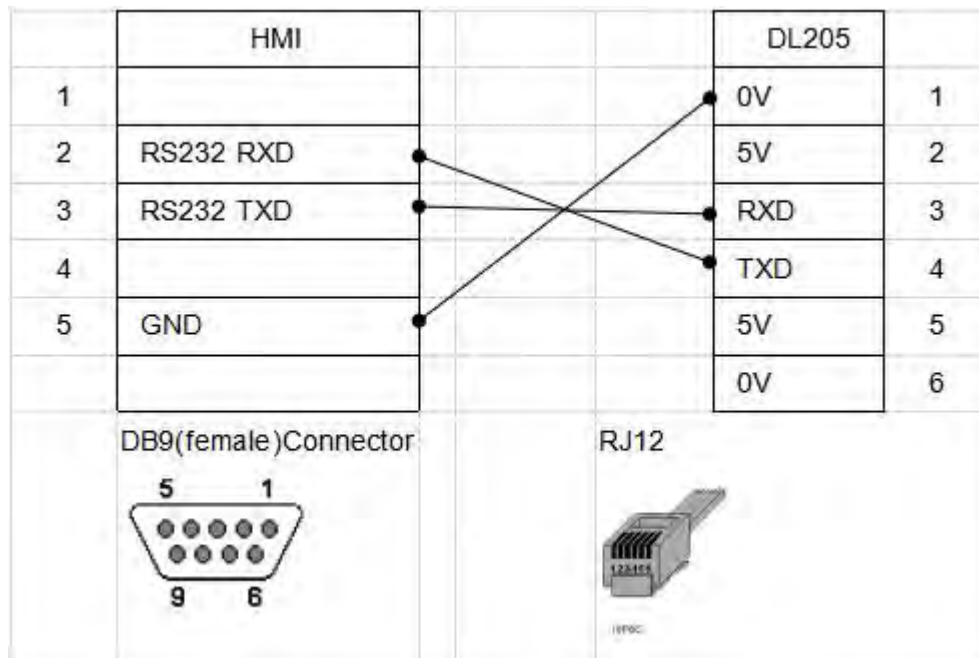

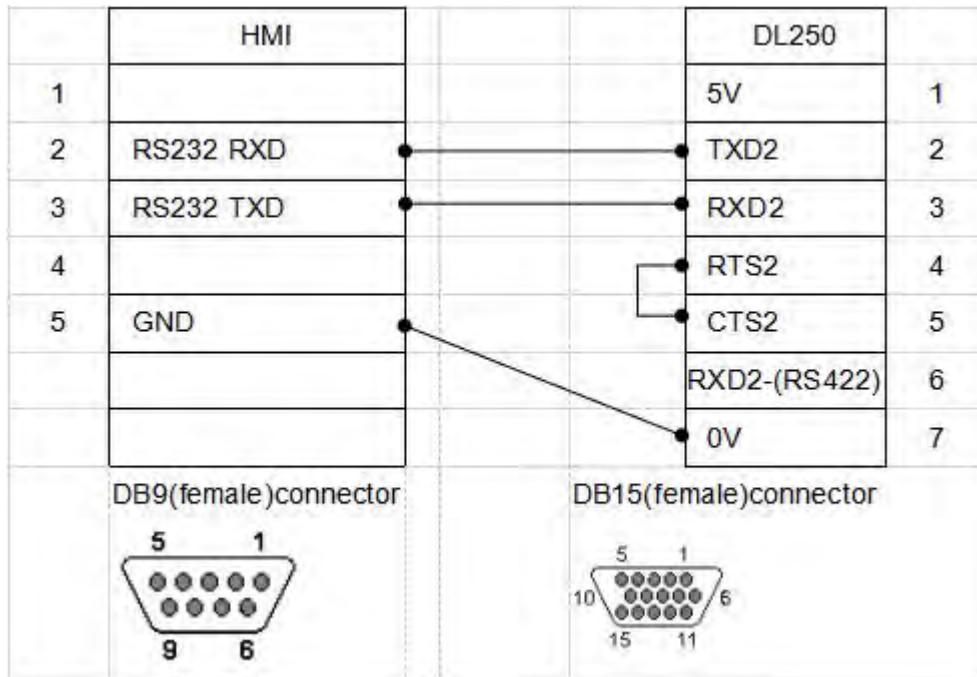

### 7.LG series

➤TK Software settings

Parameter item	Recommended settings
Protocol	LG Master-K K120S Series
Communication	RS232
Communication	38400
Synchronization	No information
Number of data	8 digits
Stop digits	1 digit

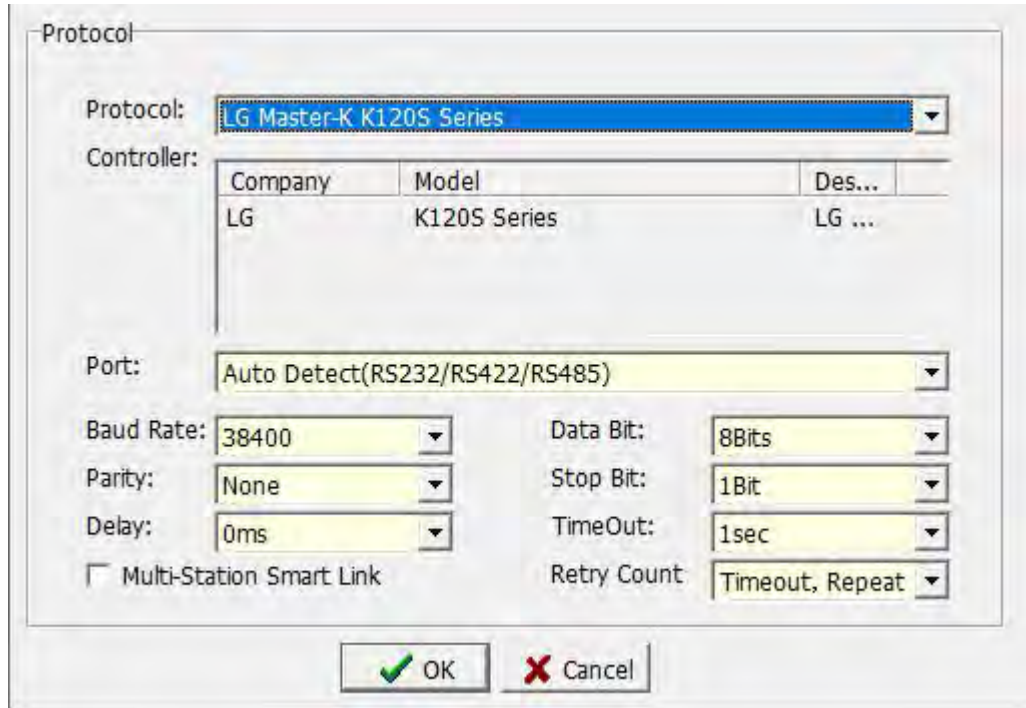

➤ Manipulable variable

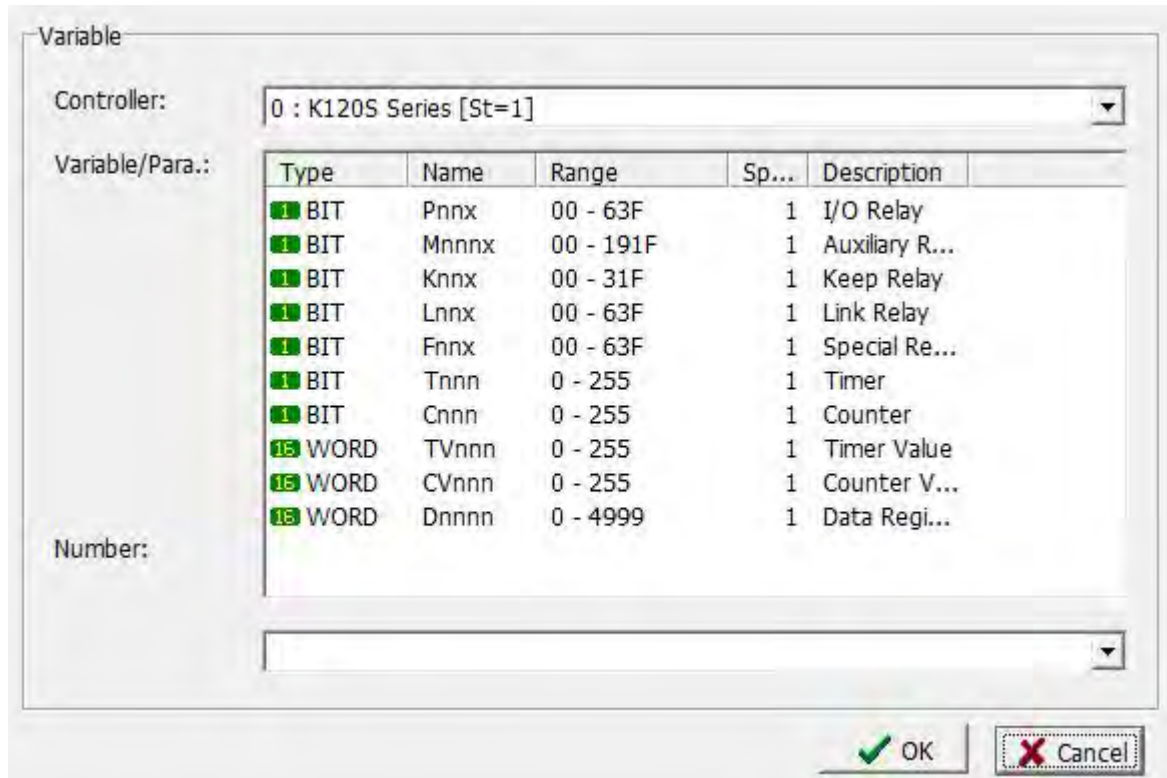

➤ TK-LG Master-K120S Communication line connection diagram

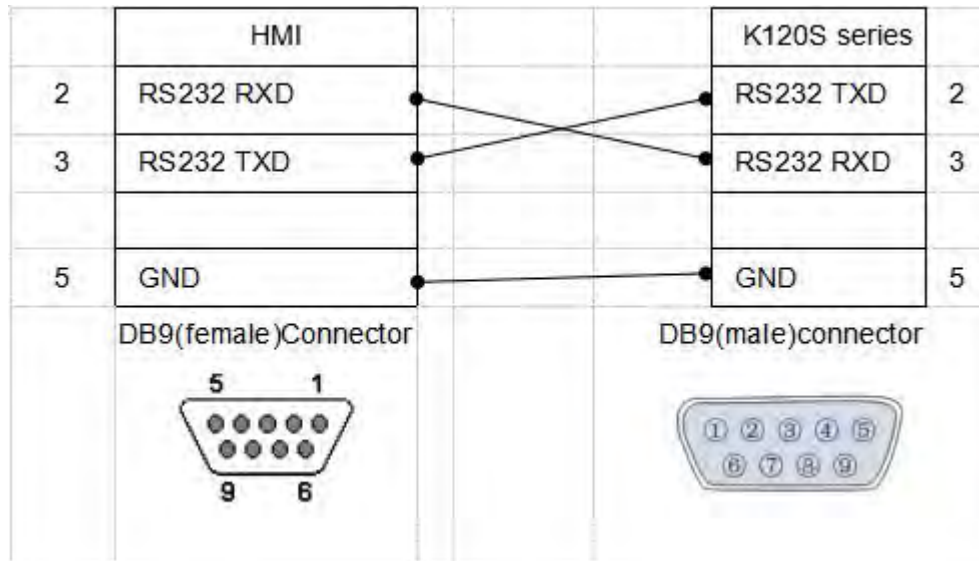

### 8. OMRON C series

➤TK Software settings

Parameter item	Recommended settings
Protocol	Omron C Series
Communication port	RS232
Communication rate	9600
Synchronization check	Even parity
Number of data	7 digits
Stop digits	2 digits

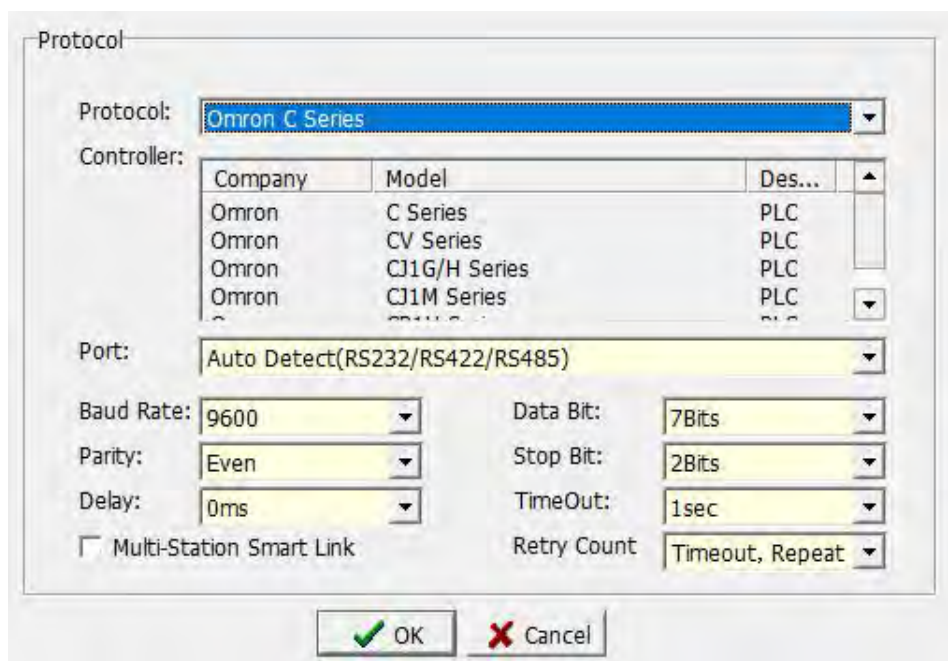



➤Manipulable variable

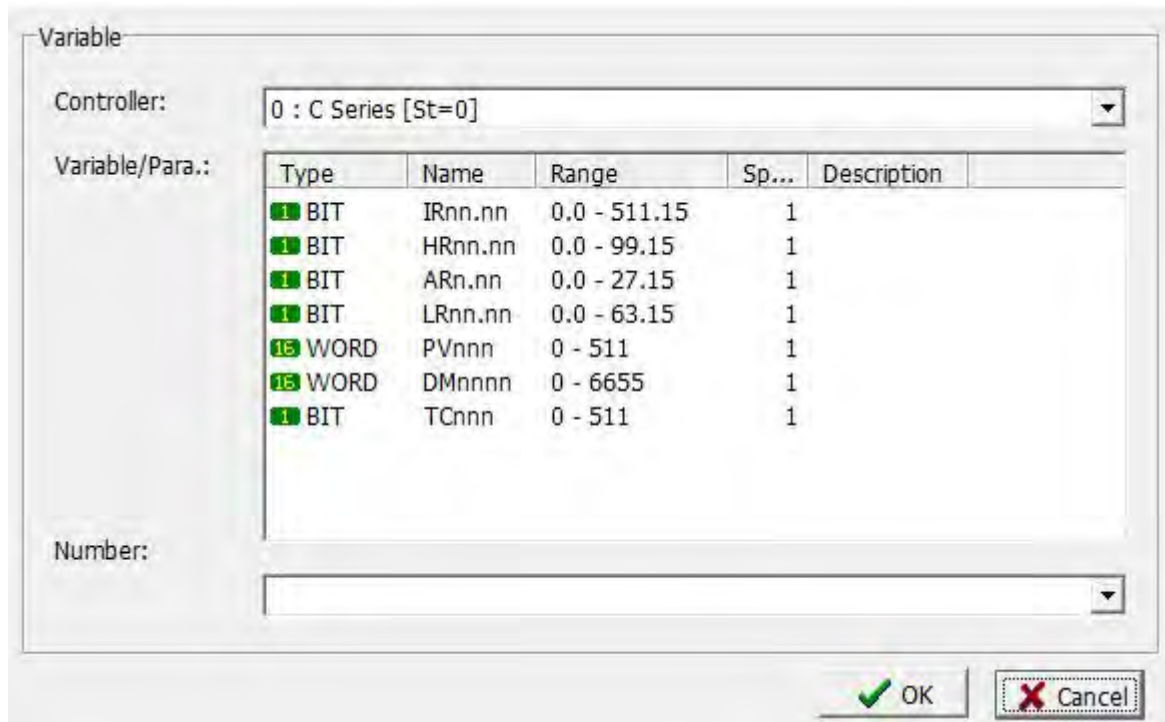

➤TK-OMRON communication cable connection diagram

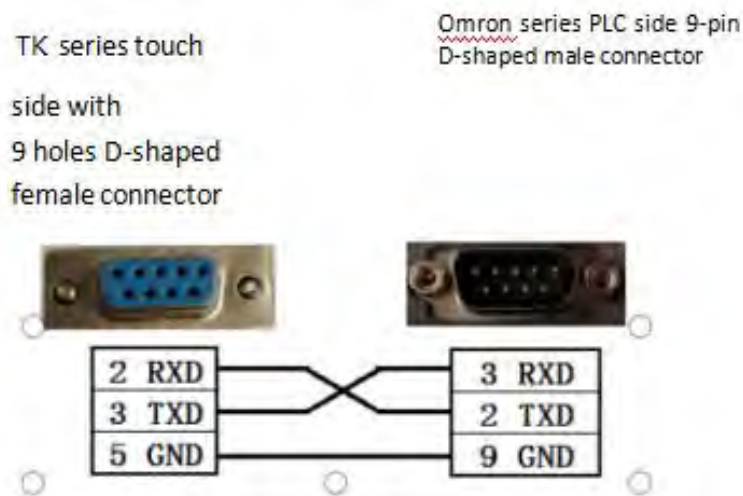

**9.Siemens S7-200 series**

➤TK Software settings

Parameter item	Recommended settings
Protocol	Simatic S7-200 Series
Communication	RS485
Communication	9600
Synchronization	Even parity

Number of data	8 digits
Stop digits	1 digit
Communication	1 second

Protocol

Protocol: **Simatic S7-200 Series**

Controller:

Company	Model	Des...
SIEMENS	Simatic S7-200	PLC

Port: **Auto Detect(RS232/RS422/RS485)**

Baud Rate: **9600** Data Bit: **8Bits**

Parity: **Even** Stop Bit: **1Bit**

Delay: **0ms** TimeOut: **1sec**

Multi-Station Smart Link Retry Count: **Timeout, Repeat**

### ➤ Manipulable variable

Variable

Controller: **0 : Simatic S7-200 [St=2]**

Variable/Para.:

Type	Name	Range	Sp...	Description
<b>16</b> WORD	VWnnnn	0 - 8190	2	
<b>16</b> WORD	TWnnn	0 - 255	1	
<b>16</b> WORD	CWnnn	0 - 255	1	
<b>16</b> WORD	AIWnn	0 - 63	1	
<b>16</b> WORD	AQWnn	0 - 63	1	
<b>1</b> BIT	In.nn	0.0 - 15.7	1	
<b>1</b> BIT	Qn.nn	0.0 - 15.7	1	
<b>1</b> BIT	Mnn.nn	0.0 - 127.7	1	
<b>1</b> BIT	Snn.nn	0.0 - 127.7	1	
<b>1</b> BIT	SMnn.nn	0.0 - 127.7	1	

Number:

➤TK-Siemens S7-200 communication line connection diagram

TK series touch side with 9 holes  
D-shaped female connector

S7-200 series PLC side 9 pin  
D type male connector

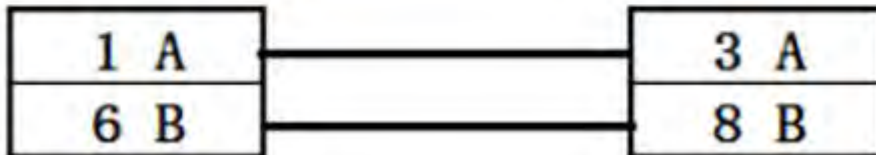

**10.Delta DVP series**

➤TK Software settings

Parameter item	Recommended settings
Protocol	DELTA DVP Series
Communication port type	RS232
Communication rate	9600
Synchronization check	Even parity
Number of data	7 digits
Stop digits	1 digit
Communication timeout	1 second

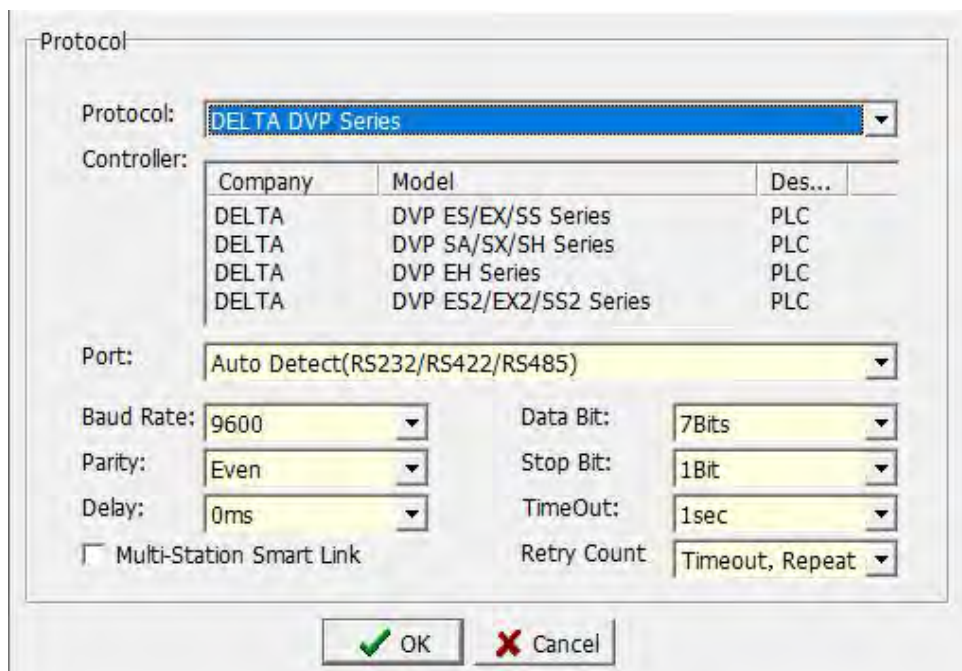

➤Manipulable variable

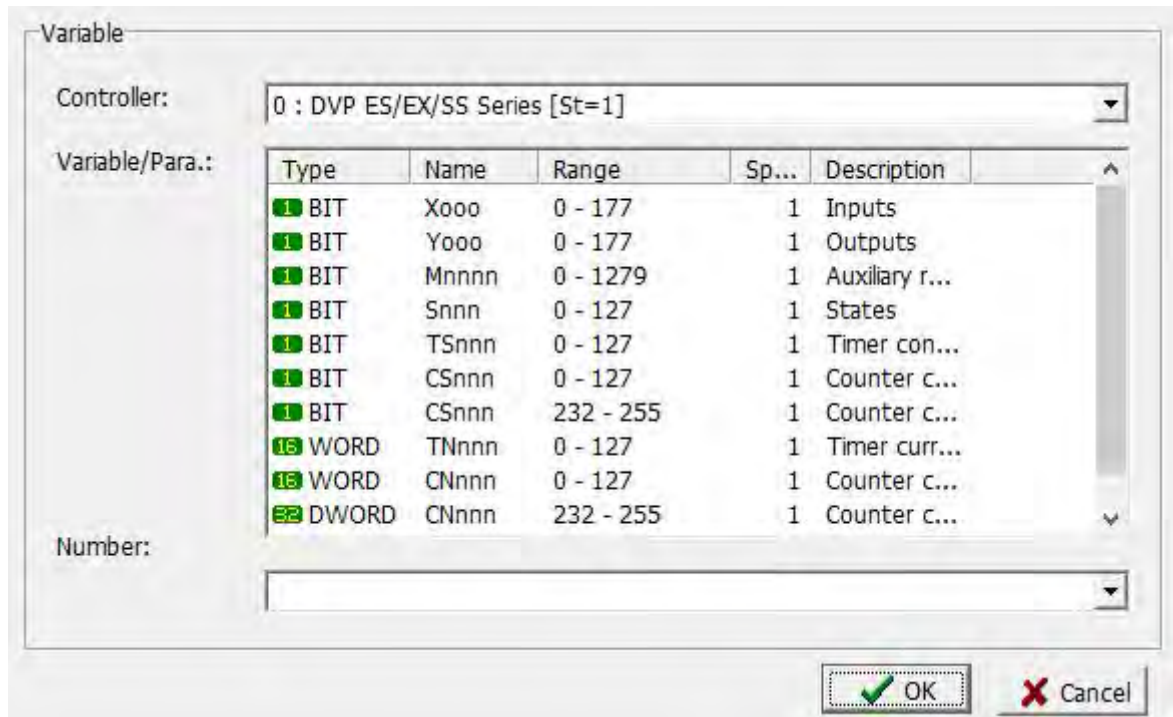

➤K-Delta DVP communication cable connection diagram

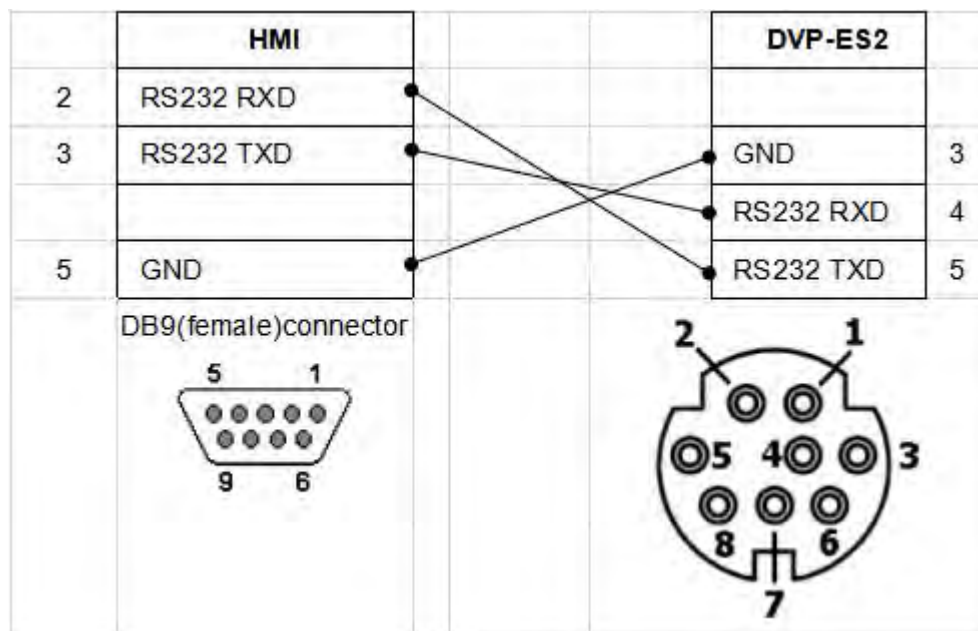

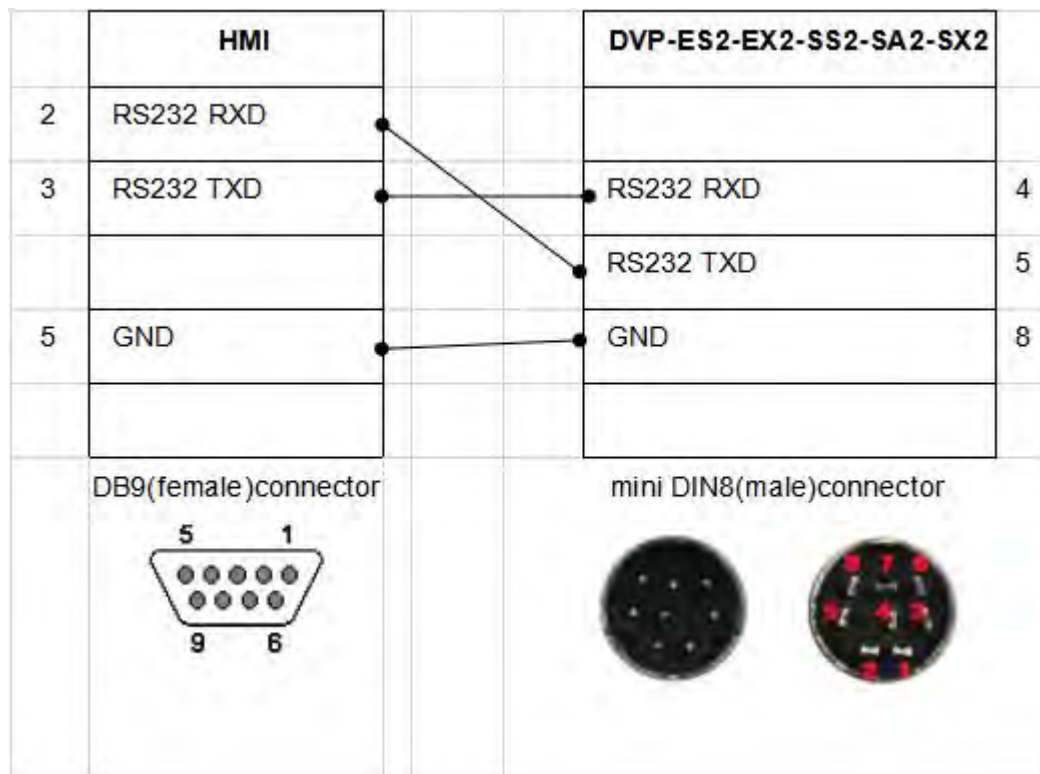

## 11. Xinjie PLC series

### ➤TK Software settings

Parameter item	Recommended settings
Protocol	Xinjie PLC Series
Communication port type	RS232
Communication rate	19200
Synchronization check	Even parity
Number of data	8 digits
Stop digits	1 digit
Communication timeout	1 second



Add Protocol

Protocol: Xinje PLC Series

Controller:

Company	Model	Des...
Xinje	Xinje XC PLC Series	PLC
Xinje	Xinje XD/XL PLC Series	PLC

Port: Auto Detect(RS232/RS422/RS485)

Baud Rate: 19200 Data Bit: 8Bits

Parity: Even Stop Bit: 1Bit

Delay: 0ms TimeOut: 1sec

Multi-Station Smart Link Retry Count: Timeout, Repeat

OK Cancel

### ➤ Manipulable variable

Variable Window

Variable

Controller: 0 : Xinje XC PLC Series [St=1]

Variable/Para.:

Type	Name	Range	Sp...	Description
BIT	Xooo	0 - 511	1	
BIT	Yooo	0 - 511	1	
BIT	Mnnnn	0 - 7999	1	
BIT	Mnnnn	8000 - 8511	1	
BIT	Snnnn	0 - 1023	1	
BIT	Tnnn	0 - 618	1	
BIT	Cnnn	0 - 634	1	
WORD	Dnnnn	0 - 7999	1	
WORD	TDnnn	0 - 618	1	
WORD	CDnnn	0 - 634	1	

Number:

OK Cancel

### ➤ TK- Xinje PLC communication line connection diagram

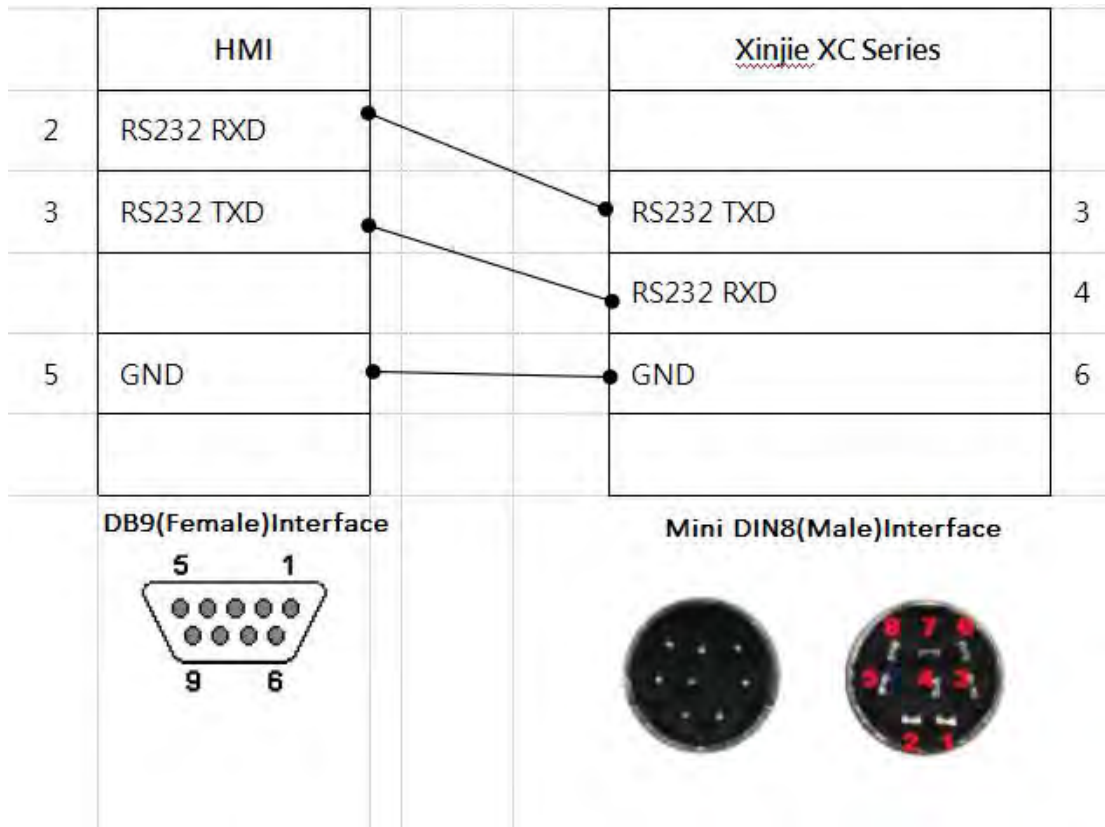

## 12. Matsushita PLC series

### ➤TK Software settings

Parameter item	Recommended settings
Protocol	Matsushita FP Series
Communication port type	RS232
Communication rate	9600
Synchronization check	Odd parity
Number of data	8 digits
Stop digits	1 digit
Communication timeout	1 second

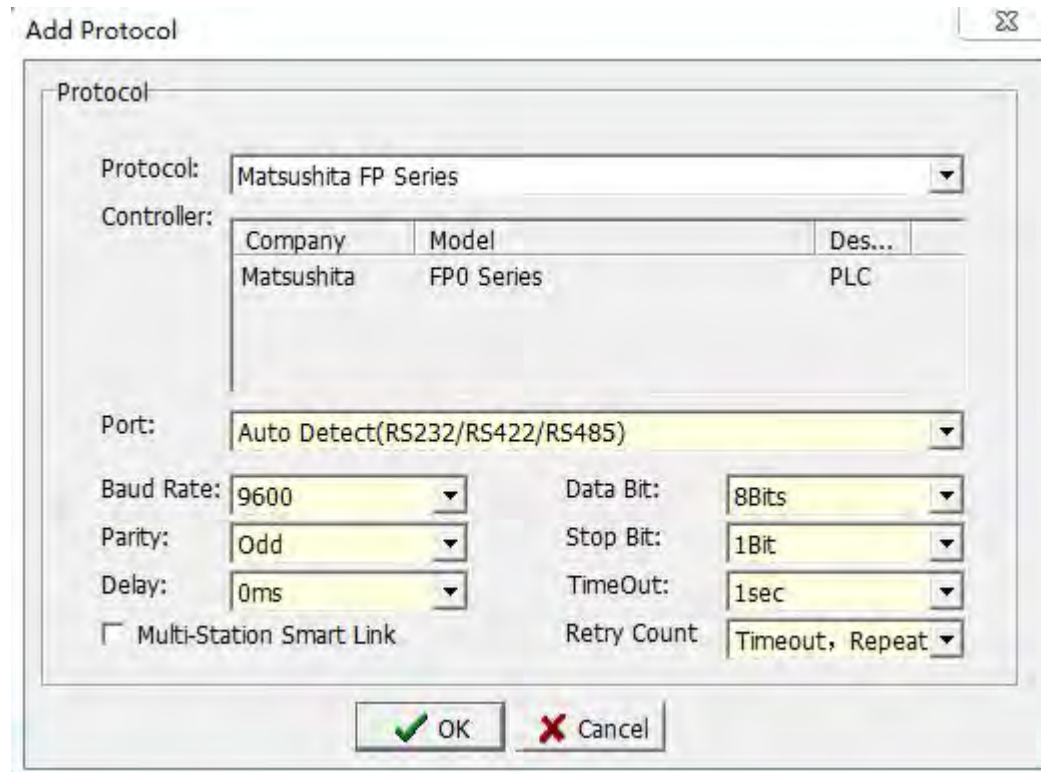

➤ Manipulable variable

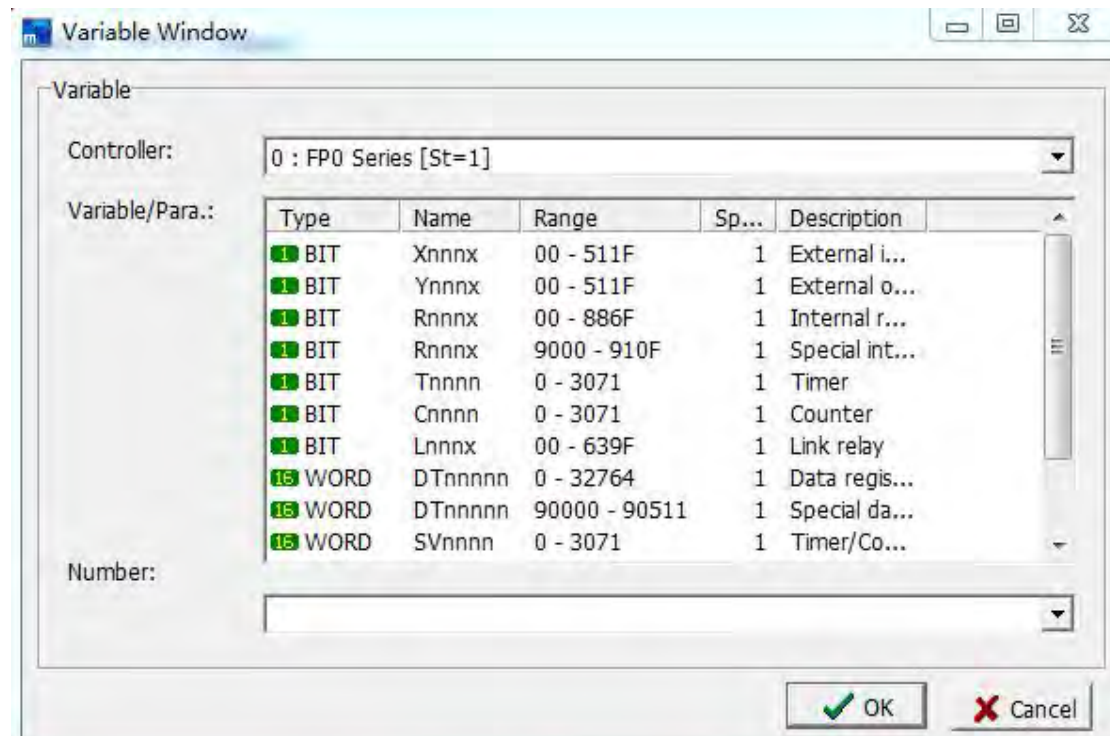

➤ TK- Matsushita PLC communication line connection diagram

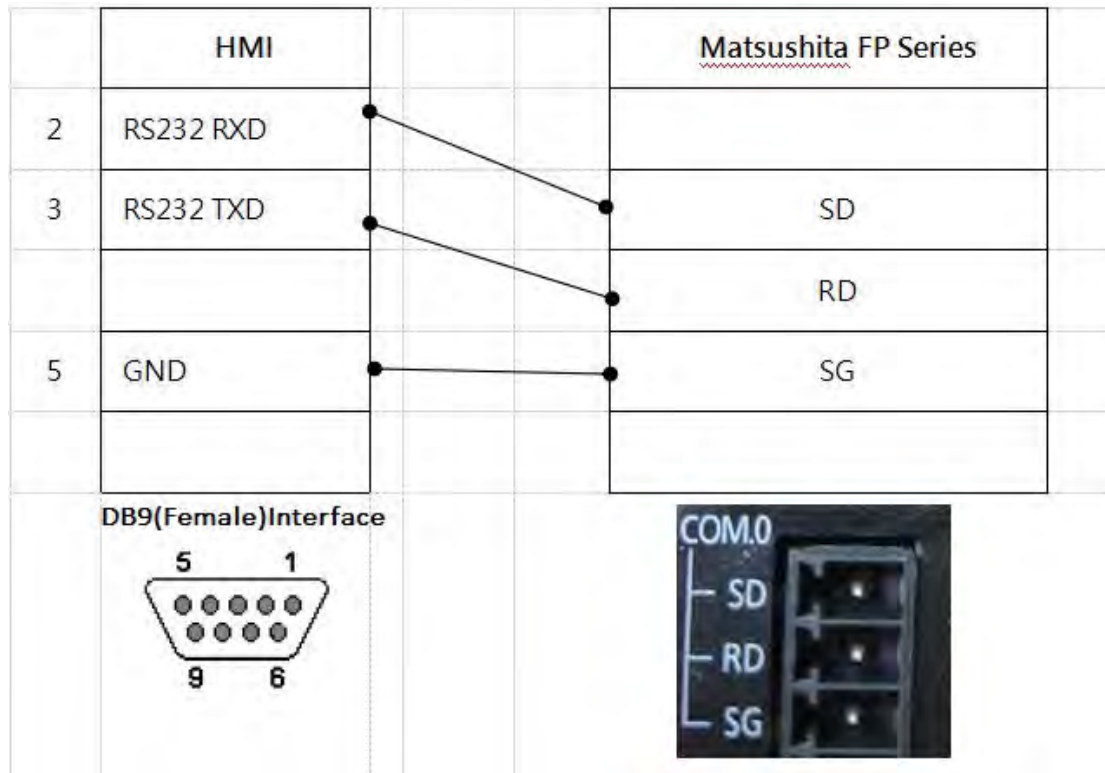

## Appendix 11 HMI program simulation and download

### 11.1 Program simulation

mView provides the function of simulating directly on the PC. You can use this function to simulate the actions performed on HMI after planning HMI. On the one hand, it increases the convenience of finding program errors, and on the other hand, it can save downloading to the time HMI can connect to the controller. The simulation function of mView is divided into two types: [On-Line Run] and [Off-Line Run], as shown in the figure below.

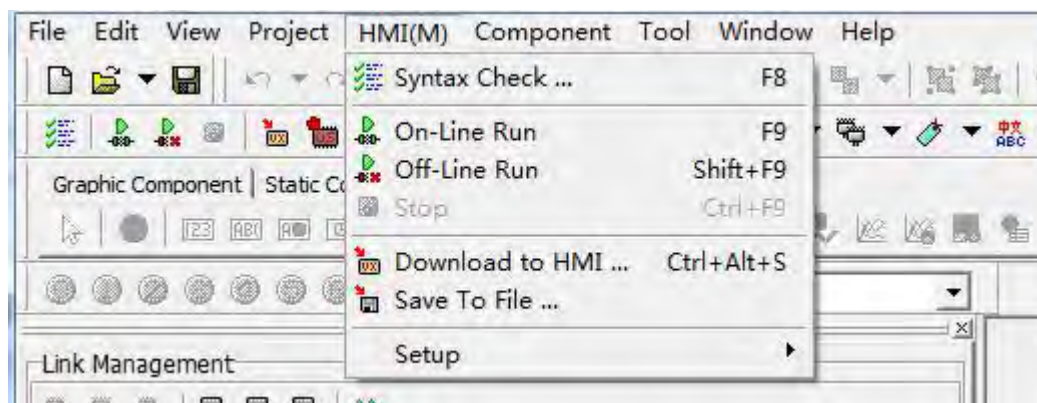



### 11.1.1 On-Line Run

This function needs to be connected to the controller, and the program will modify the corresponding contacts and registers set by the controller during execution. It can be used to verify whether the planned program can normally act on the controller.

Before [On-Line Run], you need to set up the communication, as shown in the figure below:

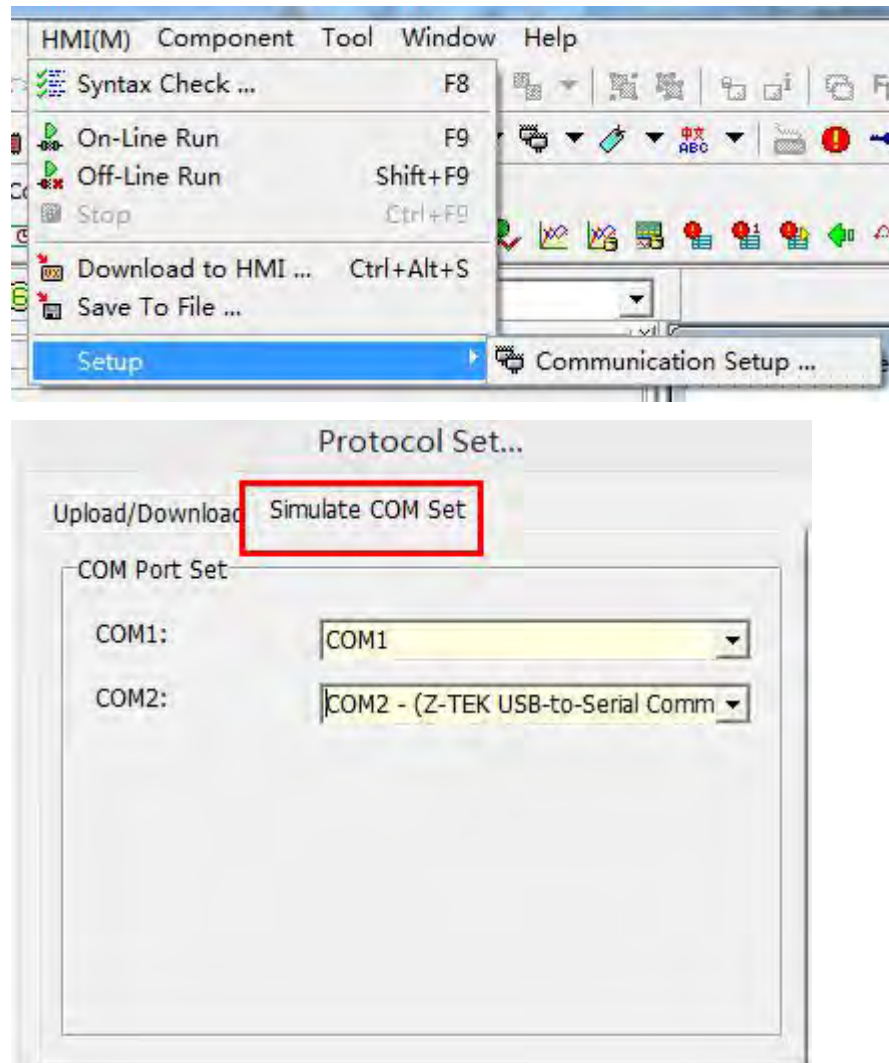

Among them, COM1 and COM2 on the left of [Communication Setup] refer to the communication ports on HMI, and the setting on the right is the set of communication ports designated by the user on the PC side to simulate the sex-corresponding communication ports of HMI side ,As shown below:



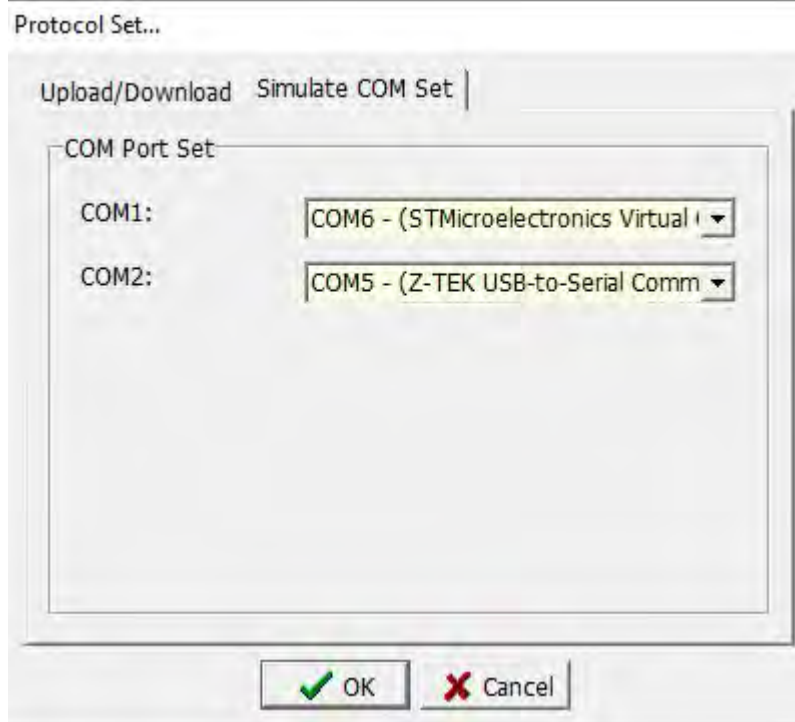
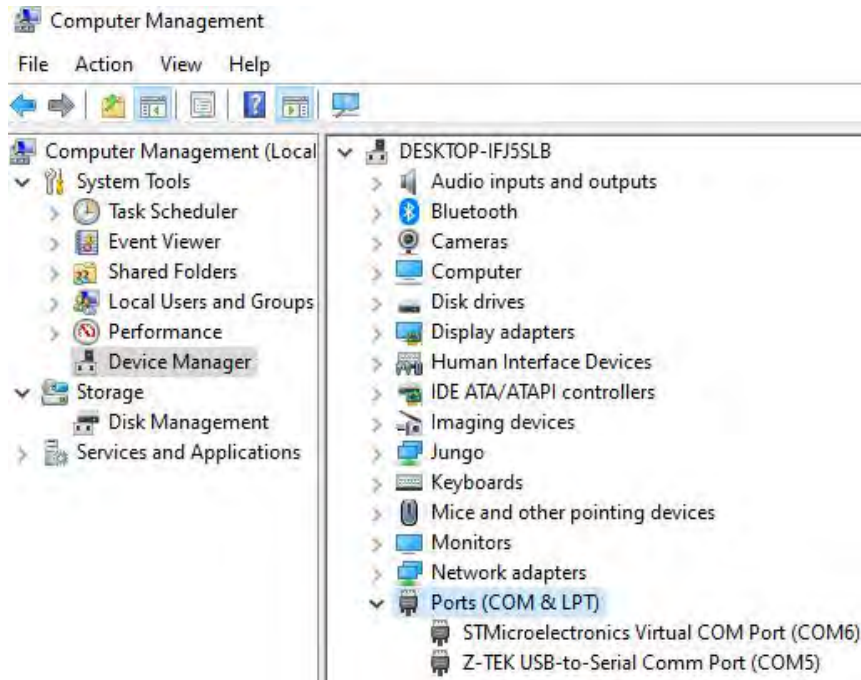

### 11.1.2 Off-Line Run

This function does not need to be actually connected to the controller, it can be used to test the normal operation of the program and the verification of various functions.

## 11.2 Program download and update O.S. version

After using the PC to simulate and verify that the program is correct, you can start downloading to the HMI and directly use HMI to connect to the controller.

### 11.2.1 Download to HMI

Before downloading the program to HMI, you need to make communication settings first, please select [HMI] → [Setup] → [Communication Setup], as shown in the figure below:

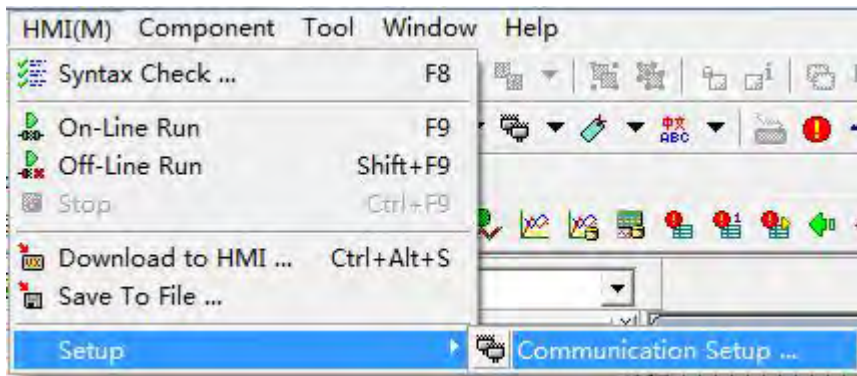

Protocol Set...

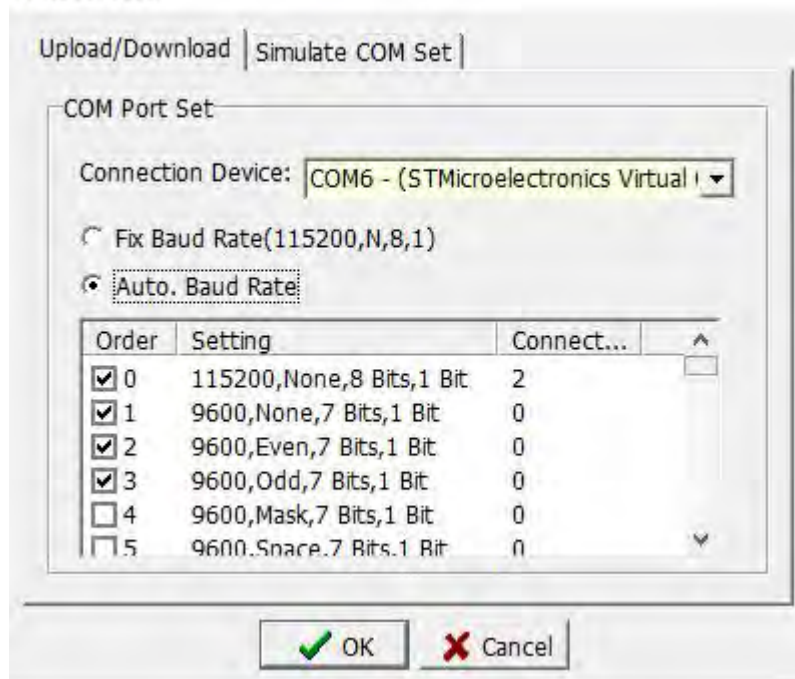

Specify the communication port of the PC in the [Upload/Download] of the communication setting window, that is, the port where the download cable is connected to the PC. For example, COM3, you can select [Use fixed communication rate] in conjunction with HMI [download screen], or let the PC automatically try to download at different rates.

Then select [HMI] → [Download to HMI], and then start to download the

HMI program to the HMI, as shown below:

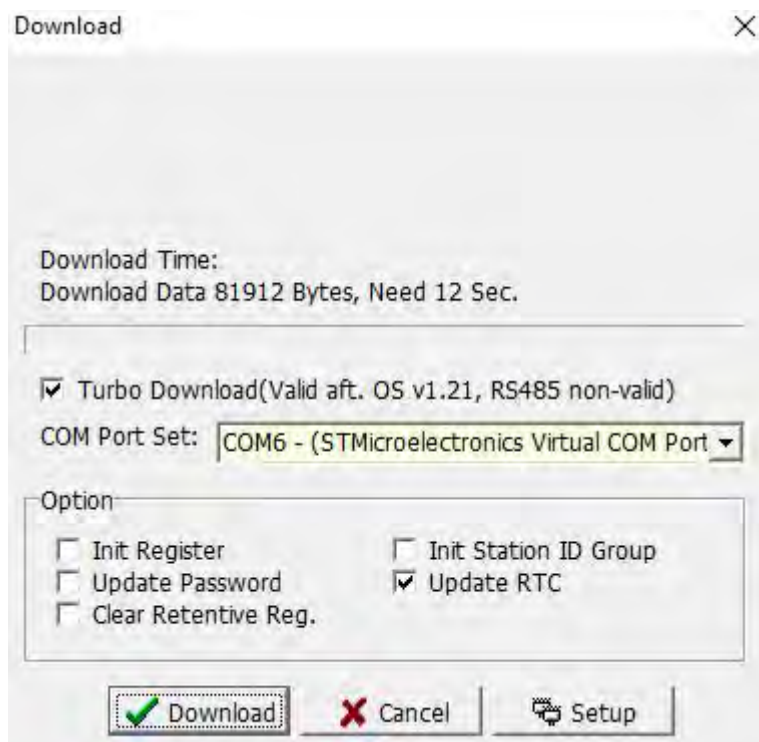
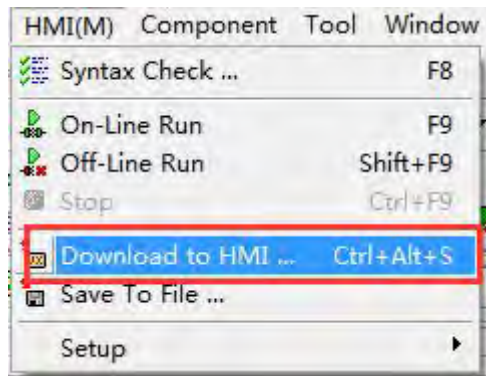

### 11.2.2 Save as HMI program

In addition to directly downloading the planned program to HMI, mView also provides the user to save the planned program into a specific file (\*.who). For downloading and using in the future, it should be noted that this file is only for downloading and its content cannot be modified.

Select [HMI]→[Save project as file...] to save the project as a special file for man-machine of type who, as shown in the figure below:

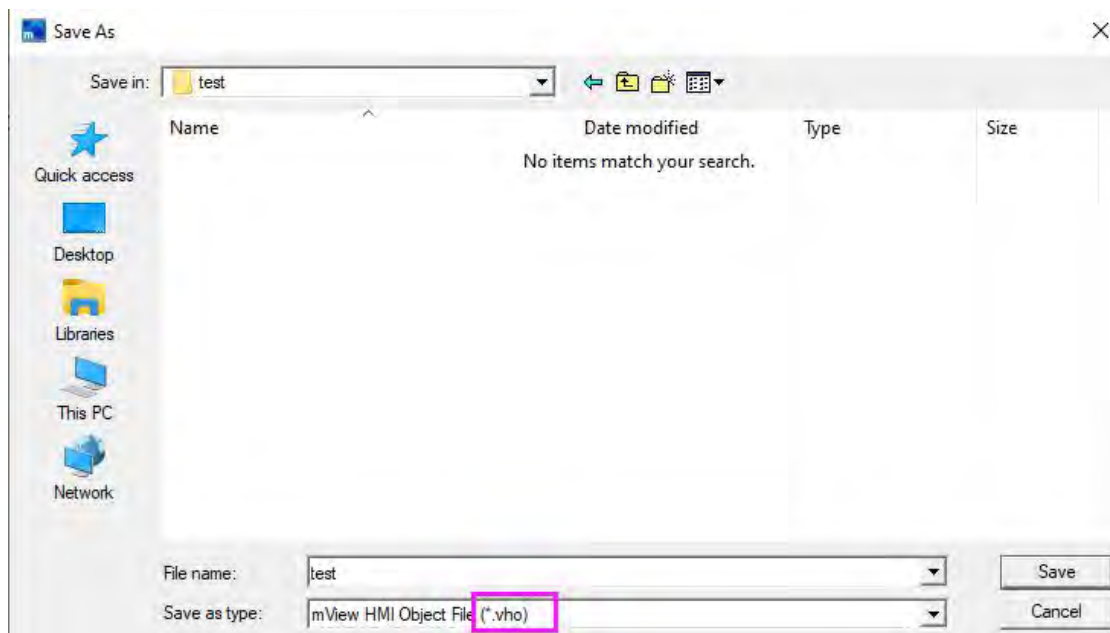
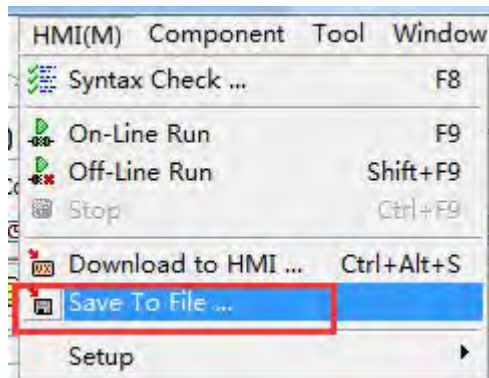

After you need to download this program to the HMI, select [Tool]→[Download HMI Program], as shown below, you can download this program to HMI.

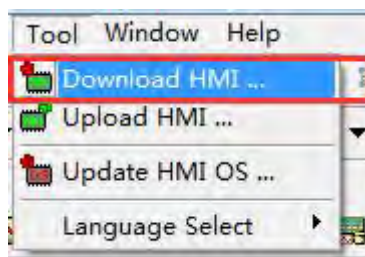

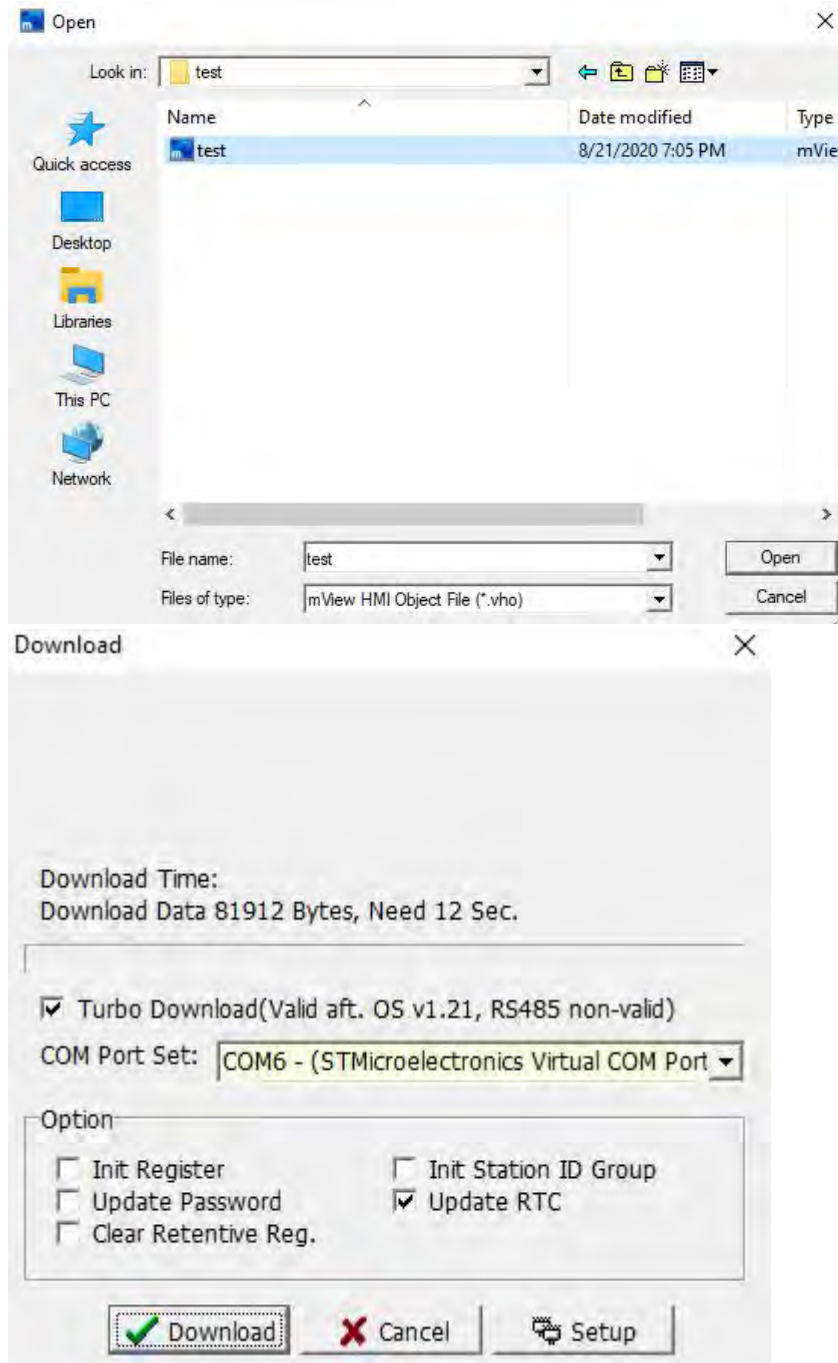

### 11.2.3 Update HMI OS

Generally speaking, when the new version of mView software is updated, it will be matched with the corresponding version of the OS. This OS supports the old version of the planning software downwards, but if the user wants to use the functions provided by the new version of the planning software, the new version must be matched OS and HMI OS are updated as follows.

Step 1: Select [Tools]→[Update HMI OS].



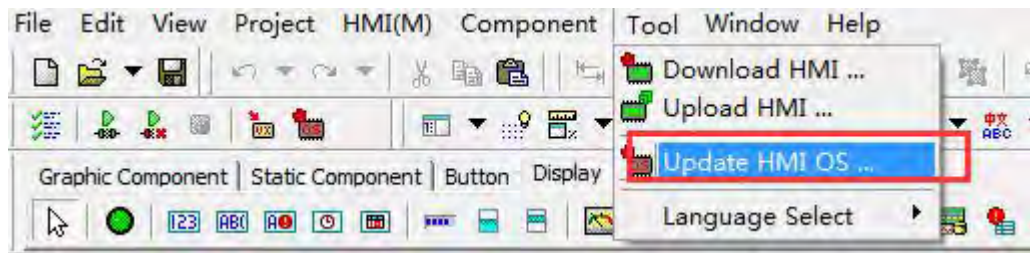

Step 2: Select the OS version to be updated (it is recommended to update with the planning software version used).

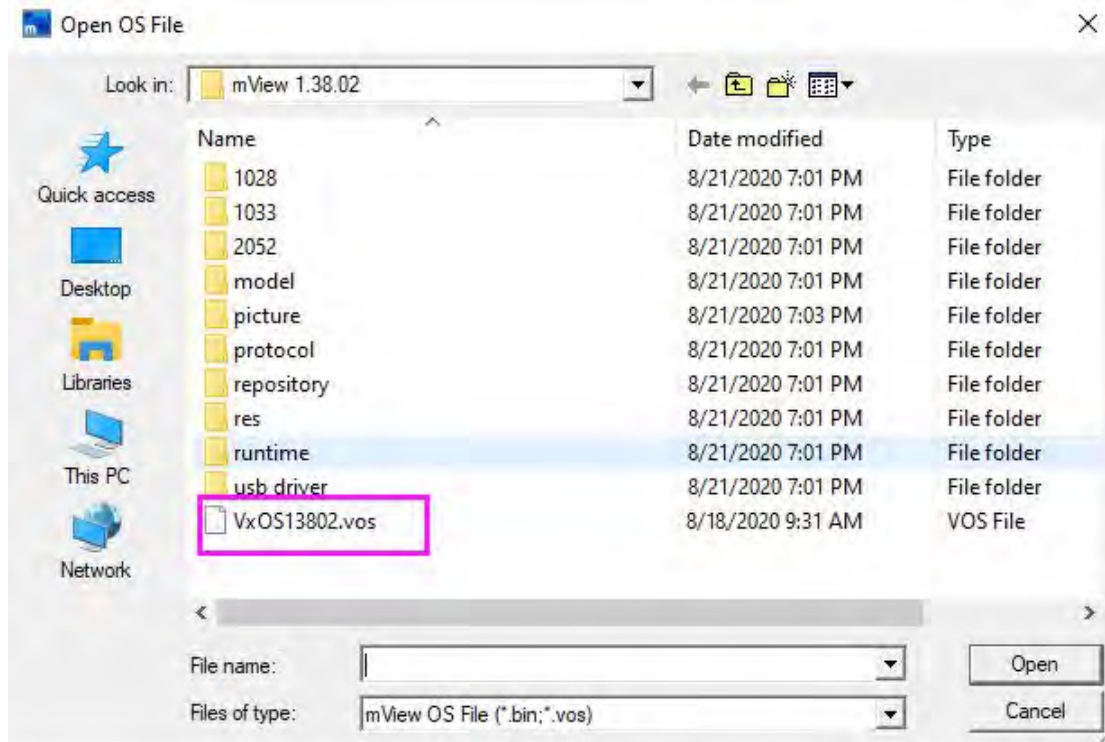

Step 3: Start downloading. (Note: During the OS download process, the HMI must not be powered off!)

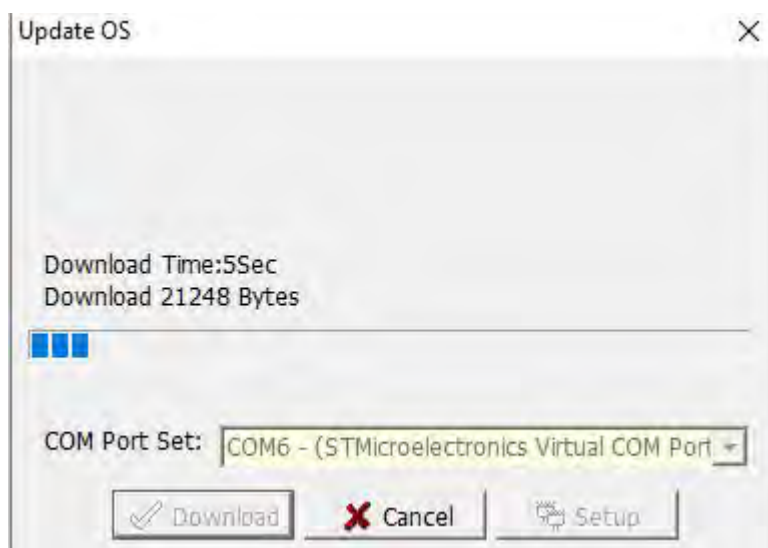

Step 4: After the download is complete, restart the power of the HMI.

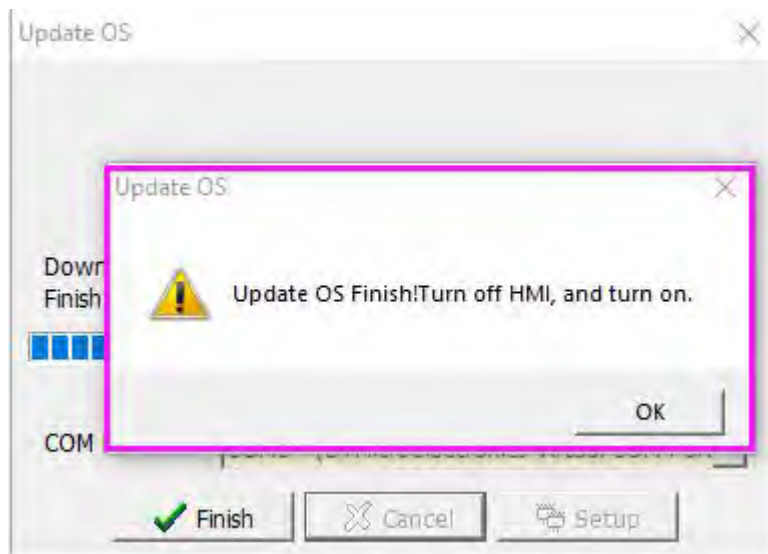

## 11.3 Program upload

Use this function to upload the program in the man-machine back to the PC and save it as an HMI program for later downloading or editing by the user.

### 11.3.1 Upload HMI program

Select [Tool]→[Upload HMI Program] to upload the program from the HMI back to the PC. After the transfer is complete, the user will be asked to save the file as a dedicated file named who, as shown in the figure below:

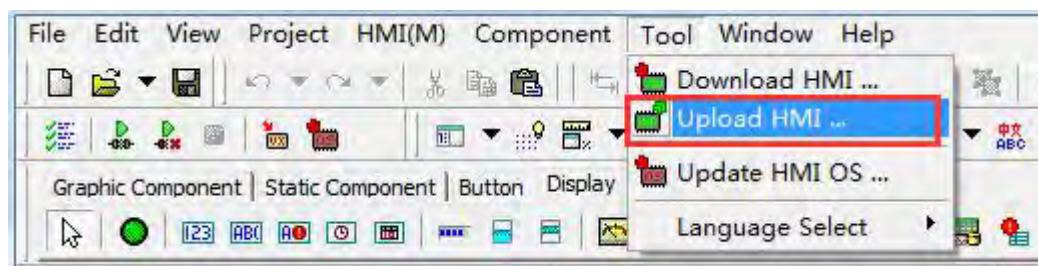

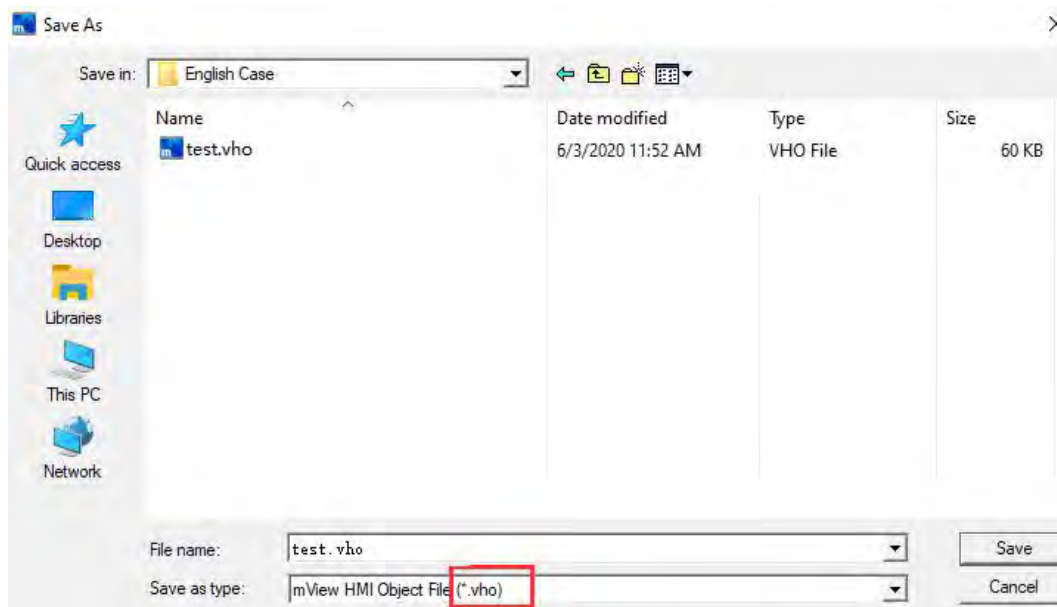
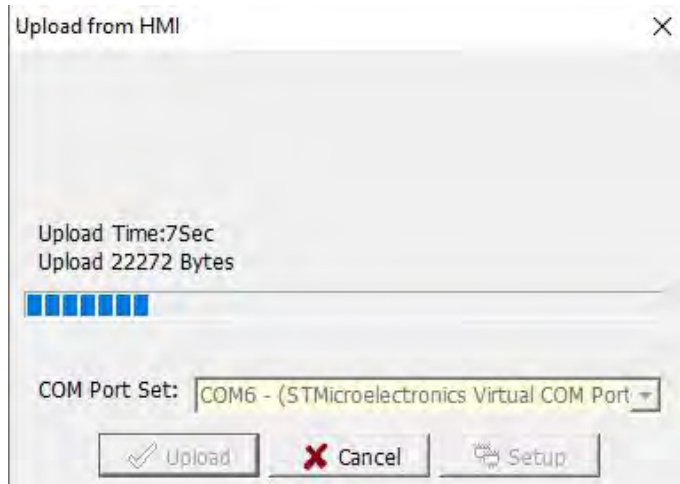

To make the uploaded program editable, you must add the decompiled information before downloading the program, otherwise the uploaded program can only be used for downloading, and the user cannot edit it.

Select [View]→[Option(H)]→[File], and tick [Add Decompiled Information].  
As shown below:

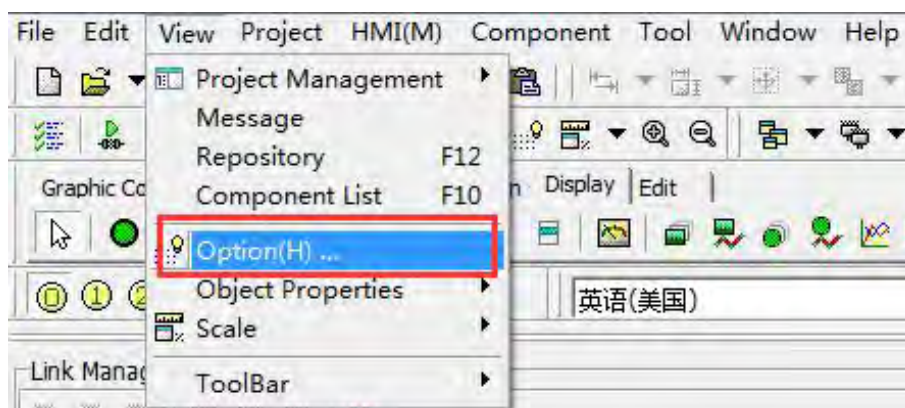

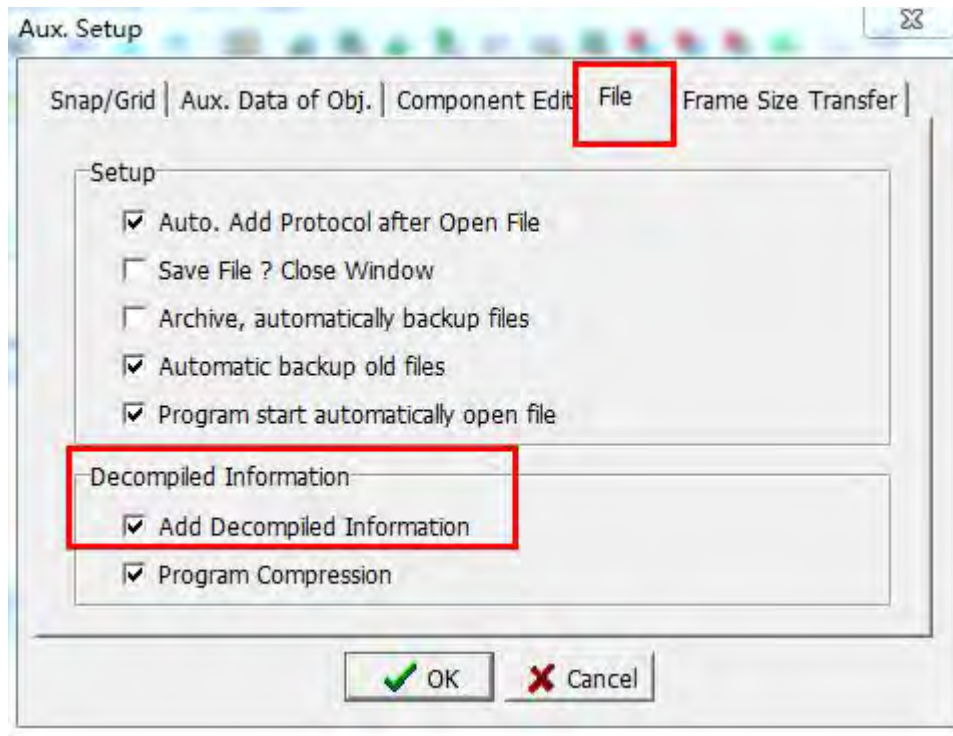



## Appendix 12 HMI USB penetrating function

The penetrating communication function provided by HMI is to use PLC programming software on the computer and connect to the PLC through the man-machine interface connected to the computer. In this way, you can monitor, upload, and download PLC programs.



As shown in the figure above, the connection between PC and HMI is USB (virtual serial port), and the connection between HMI and PLC is serial connection. For debugging convenience, the PC can directly download or monitor PLC programs through HMI to improve work efficiency.

**Note: Single screen COM1 means RS232, COM2 means RS485;  
All-in-one machine COM1 means using HMI and PLC internal communication port, COM2 means using HMI RS232 or RS485.**

### 1. COM1 penetration communication

Step 1: Set a screen button on the HMI program interface, select [65021: Virtual connection COM1] for [Screen Switch]; download the program to the touch screen.

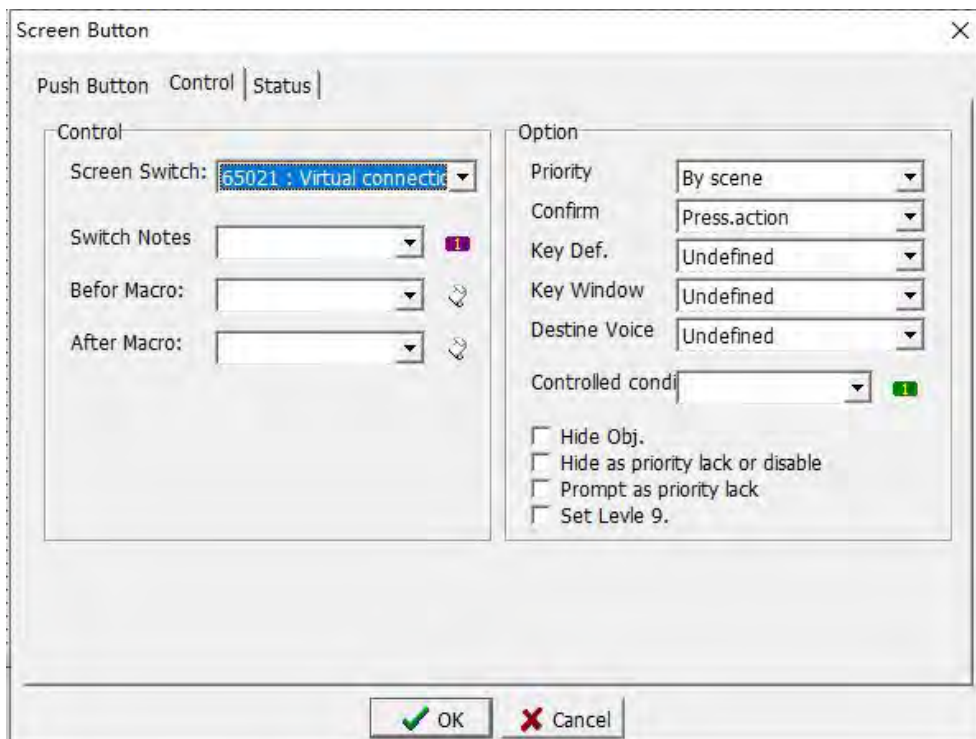



Step 2: HMI and PLC are connected through HMI COM1, the touch screen is switched to this page, and the PC can directly download or monitor PLC programs through HMI.

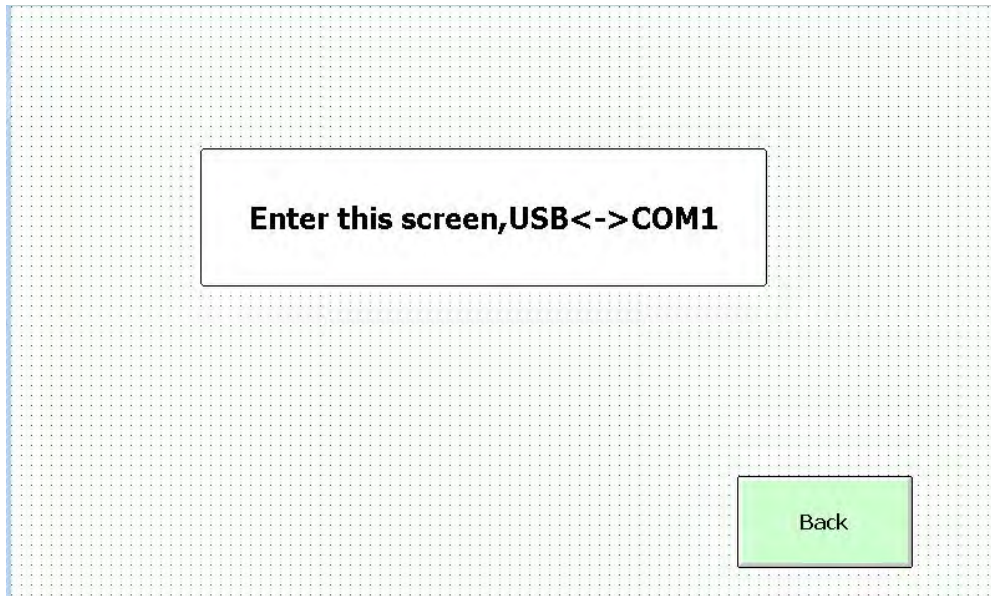

## 2. COM2 penetration communication

Step 1: Set a screen button on the HMI program interface, select [65022: Virtual connection COM2] for [Screen Switch]; download the program to the touch screen.

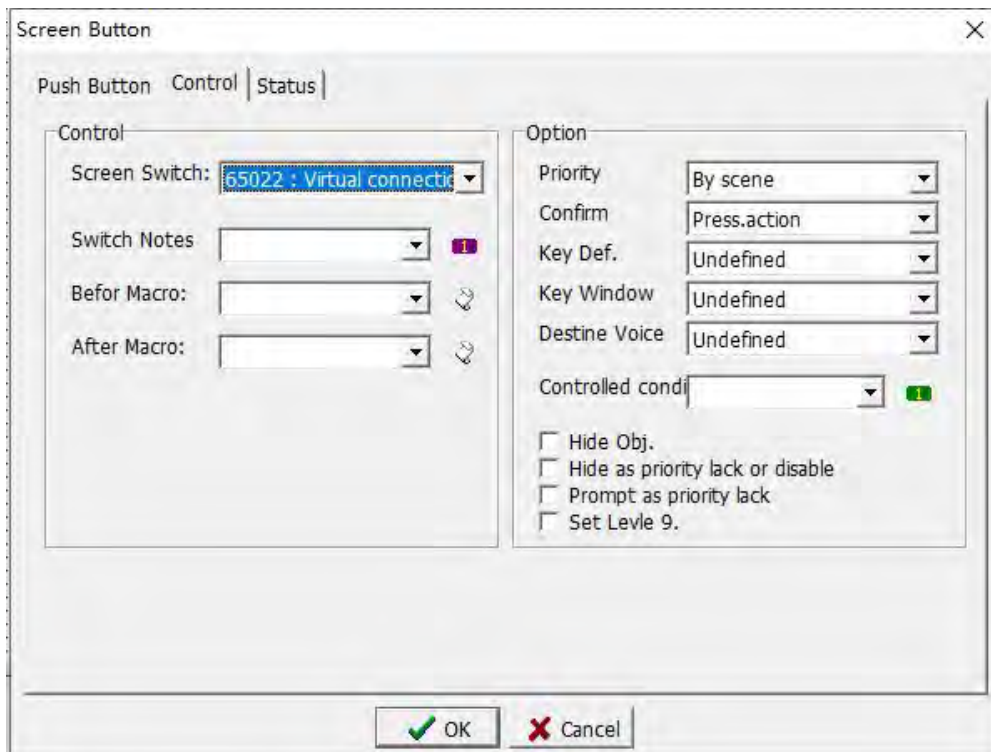

Step 2: HMI and PLC are connected through HMI COM2, the touch screen is switched to this page, and the PC can directly download or monitor PLC programs through HMI.

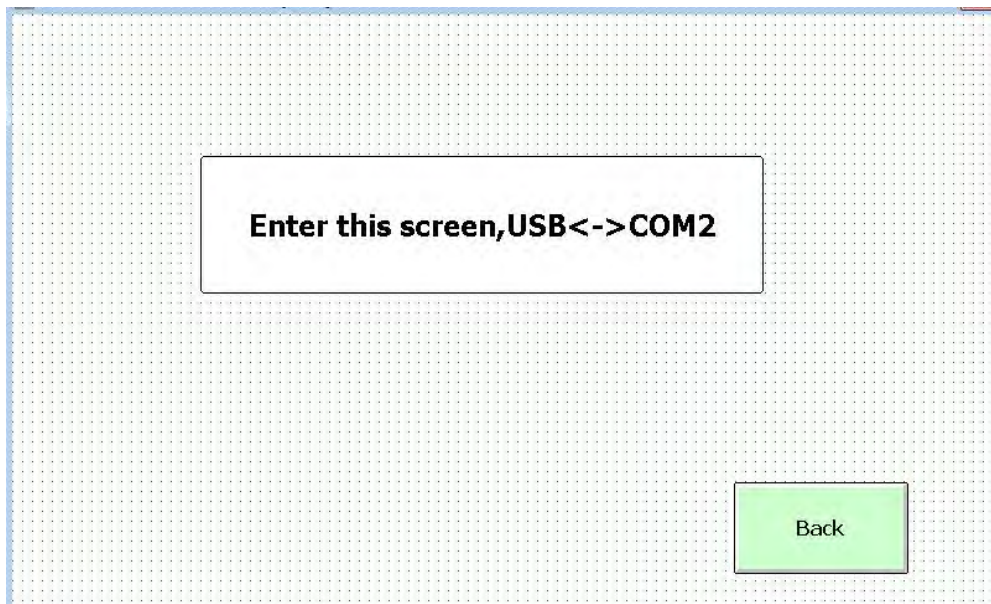

### 3. The data of COM1 and COM2 penetrate each other

Step 1: Set a screen button on the HMI program interface, select [65011: Virtual Online] for [Screen Switch]; download the program to the touch screen.

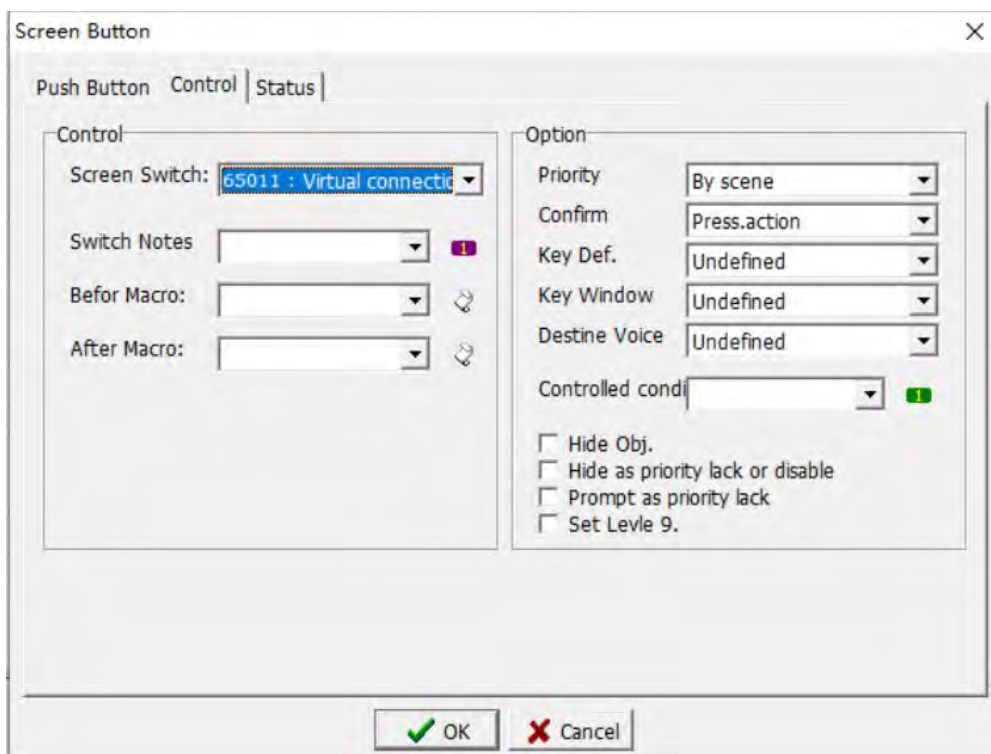

Step 2: Connect COM1 and COM2 of HMI to serial controller respectively,

the touch screen will switch to this page, and the controllers connected to COM1 and COM2 of HMI can transmit data to each other;

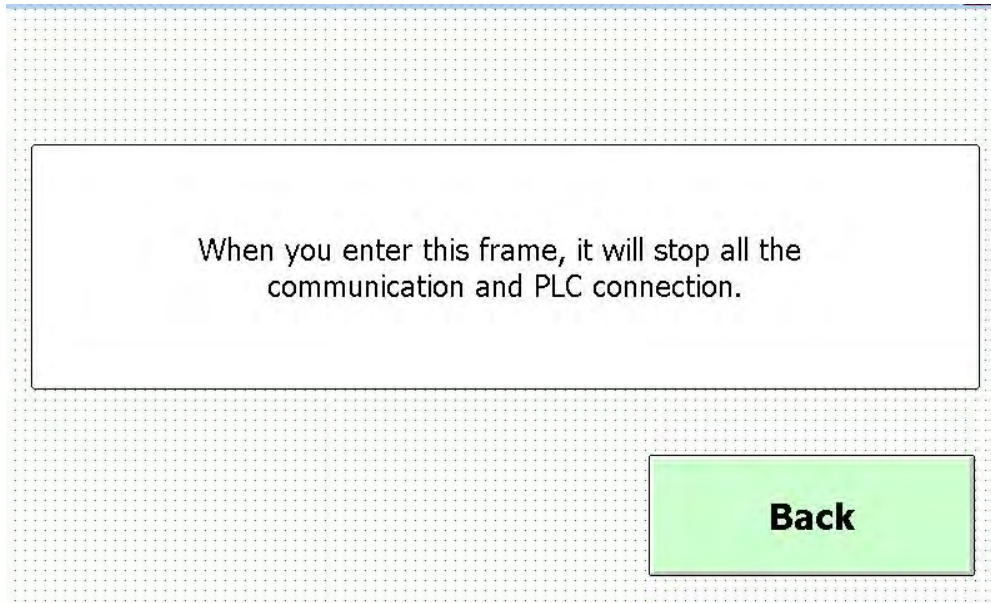

## Appendix 13 Version Change Record

Date	Changed version	Change content
Dec.2021	V21.121	<ul style="list-style-type: none"><li>◆ Appendix 8 -- Simple operation steps 6., correct the mistake</li><li>◆ 12.2.2 Introduction to Function Syntax-- 4. _REGCPY, change parameters</li></ul>